



# Cable Entry Solutions

PRODUCT PORTFOLIO



# Designed for your industry

A global leader in polymer engineering, Trelleborg Cable Entry Solutions specializes in the protection of cables to the world's most important equipment and infrastructure. Calling on over 100 years of experience, we deliver off-the-shelf products and bespoke solutions which add value to your operations. Found in everything from stationary and mobile installations through to machine tools and processing equipment, all our solutions are modeled, tested and certified to perform in the most demanding environments. Our reputation rests on our ability to deliver compliant and pioneering solutions which enhance equipment while reducing downtime, maintenance and long-term cost of ownership.

**Welcome to the frontline of innovation. Welcome to Trelleborg.**

## CONTENTS

ADVANTAGES, QUALITY	4
PRODUCT CONFIGURATOR	5
CABLE ENTRY PLATES B10, B16, B24	6 – 13
CABLE ENTRY PLATES M-GD	13 – 21
CABLE ENTRY PLATES FL21	22 – 27
CABLE ENTRY PLATES FL13	28 – 29
CABLE ENTRY PLATES SPECIAL CUT-OUT	30 – 31
SPLITTING ENTRY SYSTEMS	32 – 35
MODULAR SYSTEM	36 – 45
CABLE GROMMETS	46 – 55





## Advantages

- **Complete portfolio.** With our wide range of custom cable entry solutions matched by industry-leading expertise in this highly specialized niche, we're there to help you select the best system for your needs.
- **Connections.** We help you connect not just data and power, but your project chain and the people in it – making us a crucial link in joining everything up.
- **Protection.** With high-integrity polymer products that keep your cables, equipment, and operation working safely and efficiently.
- **Support.** Our global support network means we're accessible in all territories. Wherever you are, you'll have access to local engineering support and a robust and reliable supply chain.
- **Peace of mind.** Fully tested and compliant with all international standards, our market-leading solutions meet the high levels of safety and reassurance that the industrial industry demands.

## Quality

Our high-quality products are the result of over 100 years' experience in the industrial sector. They're manufactured in world-class plants with superior materials and technology, and they're tested using sophisticated software and technology to ensure a lifetime of reliable performance. What's more, as part of a major international group, Trelleborg Cable Entry Solutions offers you the reassurance of financial strength, global support and ongoing investment in quality and testing.

# Product Configurator

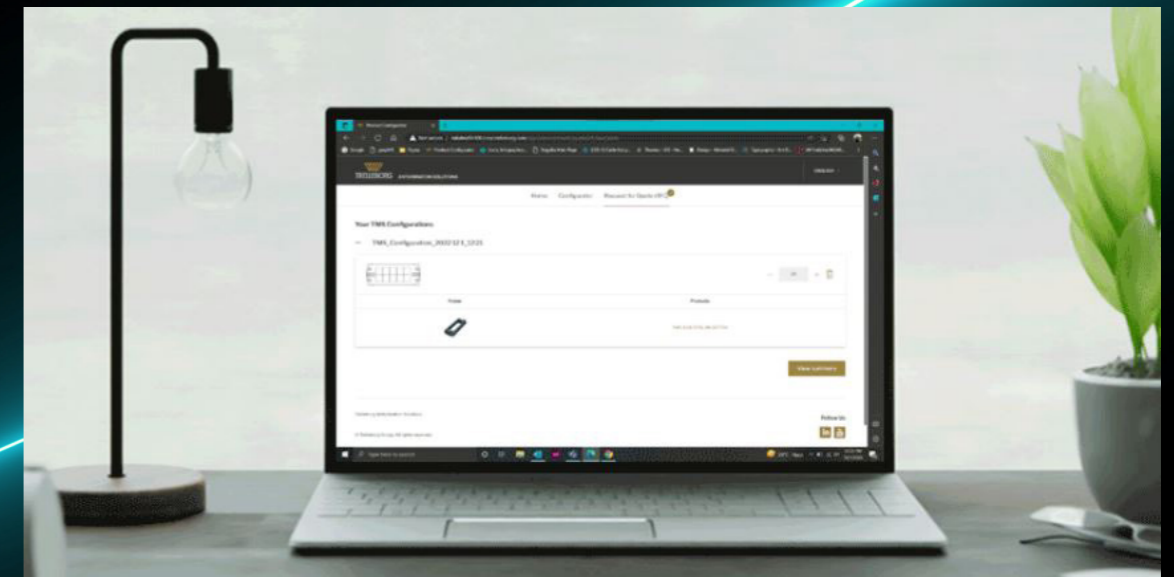

### CABLE ENTRY SOLUTIONS PRODUCT SELECTION MADE EASY WITH OUR SMART CONFIGURATOR.

With over 1,000 potential configurations it is the solution that offers maximum flexibility in electrical design, installation and service. You can create your own system depending on your requirements for number of cables and diameters, replace grommets later on if needed and use pre-assembled cables with connectors.



Create your own configuration  
Scan QR code



# Cable Entry Plates B10, B16, B24

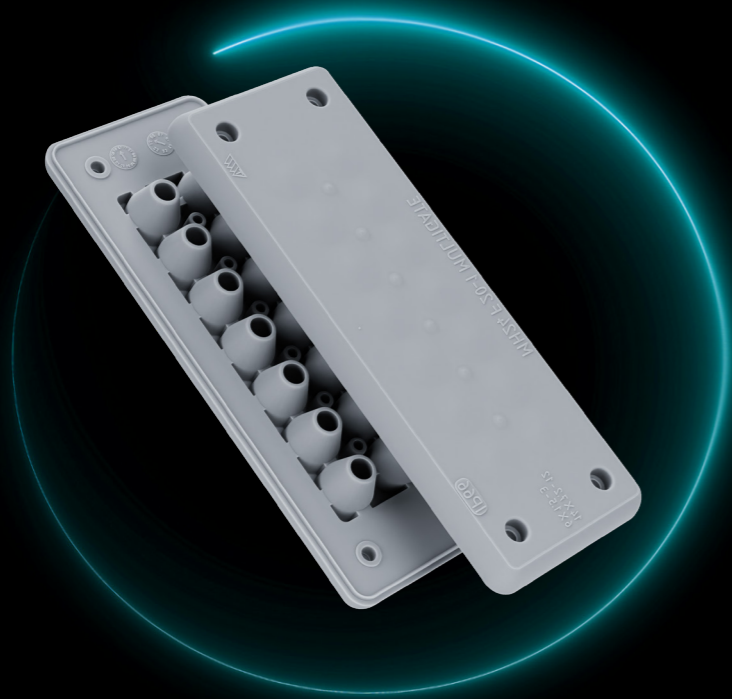

The cable entries within the “industrial connector series” align seamlessly with the cut-out dimensions of 10, 16, and 24-pin standards. Specifically engineered as an entry and fastening system for unassembled cables, tubes, and hoses, these entries offer a high cable density solution. This design facilitates the swift and efficient routing of cables into control cabinets, panels, or machines, streamlining the installation process for enhanced connectivity in industrial settings.

### Advantages

- Fast and easy assembly
- High cable density
- Double sealing with high IP protection
- Hygienic design with a flat surface structure
- Suitable for both indoor and outdoor use

### Technical Specifications

- Material: thermoplastic elastomer and fiberglass reinforced plastic
- Material properties: UL94 V-0, halogen-free
- Colour: light grey and black
- Material service temperature (unstressed): -40°C...+90°C



## Cable Entry Plates for B10 cut-out

MH10 F12-1	Art. No.	Description	Box size	Packing
 <p><b>Dimensions:</b> 107 x 56 x 19mm</p> <p><b>Flammability classification:</b> UL94 V-0</p> <p><b>Degree of protection:</b> IP66</p> <p><b>Installation range (∅):</b> 5 x 3mm - 7mm 4 x 5mm - 10mm 2 x 7mm - 13mm 1 x 9mm - 16mm <b>Total of 12 cables</b></p>	107294	MH-10 F 12-1 LIGHT GREY UL94 V-0	100	Bulk
	107294B	MH-10 F 12-1 LIGHT GREY UL94 V-0	80	Single
	107293	MH-10 F 12-1 BLACK UL94 V-0	100	Bulk
	107293B	MH-10 F 12-1 BLACK UL94 V-0	80	Single

## Cable Entry Plates for B16 cut-out

MH16 F17-1	Art. No.	Description	Box size	Packing
 <p><b>Dimensions:</b> 127 x 56 x 19mm</p> <p><b>Flammability classification:</b> UL94 V-0</p> <p><b>Degree of protection:</b> IP66</p> <p><b>Installation range (∅):</b> 12 x 3mm - 7mm 5 x 7mm - 13mm <b>Total of 17 cables</b></p>	107295	MH-16 F 17-1 LIGHT GREY UL94 V-0	100	Bulk
	107295B	MH-16 F 17-1 LIGHT GREY UL94 V-0	80	Single
	107292	MH-16 F 17-1 BLACK UL94 V-0	100	Bulk
	107292B	MH-16 F 17-1 BLACK UL94 V-0	80	Single





## Cable Entry Plates for B24 cut-out

MH24 F17-2	Art. No.	Description	Box size	Packing
 <p><b>Dimensions:</b> 154 x 56 x 19mm</p> <p><b>Flammability classification:</b> UL94 V-0</p> <p><b>Degree of protection:</b> IP66</p> <p><b>Installation range (Ø):</b> 6 x 3mm - 7mm 6 x 5mm - 10mm 5 x 9mm - 16mm <b>Total of 17 cables</b></p>	107296	MH-24 F 17-2 LIGHT GREY UL94 V-0	100	Bulk
	107296B	MH-24 F 17-2 LIGHT GREY UL94 V-0	80	Single
	107291	MH-24 F 17-2 BLACK UL94 V-0	100	Bulk
	107291B	MH-24 F 17-2 BLACK UL94 V-0	80	Single

MH24 F17-3	Art. No.	Description	Box size	Packing
 <p><b>Dimensions:</b> 154 x 56 x 19mm</p> <p><b>Flammability classification:</b> UL94 V-0</p> <p><b>Degree of protection:</b> IP66</p> <p><b>Installation range (Ø):</b> 4 x 3mm - 7mm 12 x 7mm - 12mm 1 x 10mm - 20mm <b>Total of 17 cables</b></p>	107466	MH-24 F 17-3 LIGHT GREY UL94 V-0	100	Bulk
	107466B	MH-24 F 17-3 LIGHT GREY UL94 V-0	80	Single
	107472	MH-24 F 17-3 BLACK UL94 V-0	100	Bulk
	107472B	MH-24 F 17-3 BLACK UL94 V-0	80	Single

MH24 F19-1	Art. No.	Description	Box size	Packing
 <p><b>Dimensions:</b> 154 x 56 x 19mm</p> <p><b>Flammability classification:</b> UL94 V-0</p> <p><b>Degree of protection:</b> IP66</p> <p><b>Installation range (Ø):</b> 5 x 1,5mm - 3mm 10 x 3,2mm - 6,5mm 4 x 16mm - 22mm <b>Total of 19 cables</b></p>	107558	MH-24 F 19-1 LIGHT GREY UL94 V-0	100	Bulk
	107558B	MH-24 F 19-1 LIGHT GREY UL94 V-0	80	Single
	107653	MH-24 F 19-1 BLACK UL94 V-0	100	Bulk
	107653B	MH-24 F 19-1 BLACK UL94 V-0	80	Single



## Cable Entry Plates for B24 cut-out

MH24 F20-1	Art. No.	Description	Box size	Packing
 <p><b>Dimensions:</b> 154 x 56 x 19mm</p> <p><b>Flammability classification:</b> UL94 V-0</p> <p><b>Degree of protection:</b> IP66</p> <p><b>Installation range (Ø):</b> 6 x 1,5mm - 3mm 14 x 7,2mm - 12mm <b>Total of 20 cables</b></p>	107559	MH-24 F 20-1 LIGHT GREY UL94 V-0	100	Bulk
	107559B	MH-24 F 20-1 LIGHT GREY UL94 V-0	80	Single
	107654	MH-24 F 20-1 BLACK UL94 V-0	100	Bulk
	107654B	MH-24 F 20-1 BLACK UL94 V-0	80	Single

MH24 F22-1	Art. No.	Description	Box size	Packing
 <p><b>Dimensions:</b> 154 x 56 x 19mm</p> <p><b>Flammability classification:</b> UL94 V-0</p> <p><b>Degree of protection:</b> IP66</p> <p><b>Installation range (Ø):</b> 15 x 3mm - 7mm 4 x 4,5mm - 10mm 3 x 15mm - 20mm <b>Total of 22 cables</b></p>	107481	MH-24 F 22-1 LIGHT GREY UL94 V-0	100	Bulk
	107481B	MH-24 F 22-1 LIGHT GREY UL94 V-0	80	Single
	107513	MH-24 F 22-1 BLACK UL94 V-0	100	Bulk
	107513B	MH-24 F 22-1 BLACK UL94 V-0	80	Single

MH24 F23-1	Art. No.	Description	Box size	Packing
 <p><b>Dimensions:</b> 154 x 56 x 19mm</p> <p><b>Flammability classification:</b> UL94 V-0</p> <p><b>Degree of protection:</b> IP66</p> <p><b>Installation range (Ø):</b> 4 x 1,5mm - 3mm 4 x 3,2mm - 6,3mm 10 x 4mm - 7,5mm 1 x 5,5mm - 10,5mm 1 x 8mm - 12,5mm 3 x 12mm - 16,2mm <b>Total of 23 cables</b></p>	107555	MH-24 F 23-1 LIGHT GREY UL94 V-0	100	Bulk
	107555B	MH-24 F 23-1 LIGHT GREY UL94 V-0	80	Single
	107652	MH-24 F 23-1 BLACK UL94 V-0	100	Bulk
	107652B	MH-24 F 23-1 BLACK UL94 V-0	80	Single





## Cable Entry Plates for B24 cut-out

MH24 F23-2	Art. No.	Description	Box size	Packing
 <p><b>Dimensions:</b> 154 x 56 x 19mm</p> <p><b>Flammability classification:</b> UL94 V-0</p> <p><b>Degree of protection:</b> IP66</p> <p><b>Installation range (Ø):</b> 4 x 1,5mm - 3mm 6 x 3,2mm - 6,3mm 2 x 4mm - 7,5mm 1 x 5,5mm - 10,5mm 10 x 8mm - 12,5mm <b>Total of 23 cables</b></p>	107556	MH-24 F 23-2 LIGHT GREY UL94 V-0	100	Bulk
	107556B	MH-24 F 23-2 LIGHT GREY UL94 V-0	80	Single
	107657	MH-24 F 23-2 BLACK UL94 V-0	100	Bulk
	107657B	MH-24 F 23-2 BLACK UL94 V-0	80	Single

MH24 F27-1	Art. No.	Description	Box size	Packing
 <p><b>Dimensions:</b> 154 x 56 x 19mm</p> <p><b>Flammability classification:</b> UL94 V-0</p> <p><b>Degree of protection:</b> IP66</p> <p><b>Installation range (Ø):</b> 12 x 3mm - 7mm 10 x 4,5mm - 10mm 5 x 7mm - 13mm <b>Total of 27 cables</b></p>	107480	MH-24 F 27-1 LIGHT GREY UL94 V-0	100	Bulk
	107480B	MH-24 F 27-1 LIGHT GREY UL94 V-0	80	Single
	107512	MH-24 F 27-1 BLACK UL94 V-0	100	Bulk
	107512B	MH-24 F 27-1 BLACK UL94 V-0	80	Single

MH24 F30-1	Art. No.	Description	Box size	Packing
 <p><b>Dimensions:</b> 154 x 56 x 19mm</p> <p><b>Flammability classification:</b> UL94 V-0</p> <p><b>Degree of protection:</b> IP66</p> <p><b>Installation range (Ø):</b> 30 x 3mm - 8mm <b>Total of 30 cables</b></p>	107465	MH-24 F 30-1 LIGHT GREY UL94 V-0	100	Bulk
	107465B	MH-24 F 30-1 LIGHT GREY UL94 V-0	80	Single
	107471	MH-24 F 30-1 BLACK UL94 V-0	100	Bulk
	107471B	MH-24 F 30-1 BLACK UL94 V-0	80	Single



## Cable Entry Plates for B24 cut-out

MH24 F30-2	Art. No.	Description	Box size	Packing
 <p><b>Dimensions:</b> 154 x 56 x 19mm</p> <p><b>Flammability classification:</b> UL94 V-0</p> <p><b>Degree of protection:</b> IP66</p> <p><b>Installation range (Ø):</b> 8 x 1,5mm - 3mm 8 x 3,2mm - 5,5mm 6 x 4mm - 7,5mm 6 x 5mm - 8,5mm 2 x 9,5mm - 14,5mm <b>Total of 30 cables</b></p>	107554	MH-24 F 30-2 LIGHT GREY UL94 V-0	100	Bulk
	107554B	MH-24 F 30-2 LIGHT GREY UL94 V-0	80	Single
	107658	MH-24 F 30-2 BLACK UL94 V-0	100	Bulk
	107658B	MH-24 F 30-2 BLACK UL94 V-0	80	Single

MH24 F30-3	Art. No.	Description	Box size	Packing
 <p><b>Dimensions:</b> 154 x 56 x 19mm</p> <p><b>Flammability classification:</b> UL94 V-0</p> <p><b>Degree of protection:</b> IP66</p> <p><b>Installation range (Ø):</b> 6 x 1,5mm - 3mm 4 x 3,2mm - 6,3mm 14 x 4mm - 7,5mm 2 x 8mm - 12,5mm 4 x 5,5mm - 10,5mm <b>Total of 22 cables</b></p>	107557	MH-24 F 30-3 LIGHT GREY UL94 V-0	100	Bulk
	107557B	MH-24 F 30-3 LIGHT GREY UL94 V-0	80	Single
	107659	MH-24 F 30-3 BLACK UL94 V-0	100	Bulk
	107659B	MH-24 F 30-3 BLACK UL94 V-0	80	Single

MH24 F31-1	Art. No.	Description	Box size	Packing
 <p><b>Dimensions:</b> 154 x 56 x 19mm</p> <p><b>Flammability classification:</b> UL94 V-0</p> <p><b>Degree of protection:</b> IP66</p> <p><b>Installation range (Ø):</b> 20 x 3,2mm - 6,5mm 8 x 5mm - 10,2mm 3 x 7,5mm - 12mm <b>Total of 31 cables</b></p>	107561	MH-24 F 31-1 LIGHT GREY UL94 V-0	100	Bulk
	107561B	MH-24 F 31-1 LIGHT GREY UL94 V-0	80	Single
	107655	MH-24 F 31-1 BLACK UL94 V-0	100	Bulk
	107655B	MH-24 F 31-1 BLACK UL94 V-0	80	Single





## Cable Entry Plates for B24 cut-out

MH24 F42-1	Art. No.	Description	Box size	Packing
 <p><b>Dimensions:</b> 154 x 56 x 19mm</p> <p><b>Flammability classification:</b> UL94 V-0</p> <p><b>Degree of protection:</b> IP66</p> <p><b>Installation range (∅):</b> 42 x 3,2mm - 6,5mm <b>Total of 42 cables</b></p>	107560	MH-24 F 42-1 LIGHT GREY UL94 V-0	100	Bulk
	107560B	MH-24 F 42-1 LIGHT GREY UL94 V-0	80	Single
	107656	MH-24 F 42-1 BLACK UL94 V-0	100	Bulk
	107656B	MH-24 F 42-1 BLACK UL94 V-0	80	Single

MH24 F125-1	Art. No.	Description	Box size	Packing
 <p><b>Dimensions:</b> 154 x 56 x 19mm</p> <p><b>Flammability classification:</b> UL94 V-0</p> <p><b>Degree of protection:</b> IP66</p> <p><b>Installation range (∅):</b> 123 x 1,5mm - 3mm 2 x 2,5mm - 5mm <b>Total of 125 cables</b></p>	107562	MH-24 F 125-1 LIGHT GREY UL94 V-0	100	Bulk
	107562B	MH-24 F 125-1 LIGHT GREY UL94 V-0	80	Single
	107651	MH-24 F 125-1 BLACK UL94 V-0	100	Bulk
	107651B	MH-24 F 125-1 BLACK UL94 V-0	80	Single

CABLE/ TUBE DIAMETER	MH-10 F12-1	MH-16 F17-1	MH-24 F17-2	MH-24 F17-3	MH-24 F22-1	MH-24 F27-1	MH-24 F30-1	MH-24 F19-1	MH-24 F20-1	MH-24 F23-1	MH-24 F23-2	MH-24 F30-2	MH-24 F30-3	MH-24 F31-1	MH-24 F42-1	MH24 F125-1
1.5-3mm								5	6	4	4	8	6			123
2.5-5mm																2
3-7mm	5	12	6	4	15	12										
3-8mm							30									
3.2-5.5mm												8				
3.2-6.3mm										4	6		4			
3.2-6.5mm								10						20	42	
4-7.5mm										10	2	6	14			
4.5-10mm					4	10										
5-8.5mm												6				
5-10mm	4		6													
5-10.2mm															8	
5.5-10.5mm										1	1		4			
7-13mm	2	5				5										
7-12mm				12												
7.2-12mm									14							
7.5-12mm															3	
8-12.5mm										1	10		2			
9-16mm	1		5													
9.5-14.5mm												2				
10-20mm				1												
12-16.2mm										3						
15-20mm					3											
16-22mm								4								



# Cable Entry Plates M-GD



The cable entries of the new M-GD serie match the cut-out dimensions from M20 to M50 with a various combinations of cable solutions. They have been designed as an entry system for unassembled cables, tubes and hoses. These high cable density entries enable fast routing of cables into control cabinets, panels or machines and thanks to the flexible outer lip design, can be installed into cabinet walls with thickness variable from 1 to 4mm.

### Advantages

- Fast and easy assembly
- High cable density
- High IP protection (P65)
- Hygienic design with a flat surface structure
- Designed for cabinet walls of 1 to 4mm thickness in one product
- Suitable for both indoor and outdoor use

### Technical Specifications

- Material: thermoplastic elastomer and fiberglass reinforced plastic
- Material properties: UL94 V-0, halogen-free
- Colour: light grey and black
- Material service temperature (unstressed): -40°C...+90°C

IP65  
EN 60529



RoHS  
Compliant



## Cable Entry Plates M-GD

M-GD 20-4	Art. No.	Description	Cut-out	Cut-out Ø	Plate thickness
-----------	----------	-------------	---------	-----------	-----------------



**Material:** TPE  
**Colour:** Light grey  
**Dimensions:** 32.2 x 13mm  
**Flammability classification:** UL94 V-0  
**Degree of protection:** IP65  
**Installation range (Ø):** 4 x 1mm - 5,2mm  
**Total of 4 cables**

107941	M-GD 20-4 LIGHT GREY UL94 V-0	M20	Ø20.5mm	1-4mm
--------	----------------------------------	-----	---------	-------

M-GD 20-4.1	Art. No.	Description	Cut-out	Cut-out Ø	Plate thickness
-------------	----------	-------------	---------	-----------	-----------------



**Material:** TPE  
**Colour:** Light grey  
**Dimensions:** 32.2 x 13mm  
**Flammability classification:** UL94 V-0  
**Degree of protection:** IP65  
**Installation range (Ø):** 2 x 1mm - 8mm  
 2 x 1mm - 4,5mm  
**Total of 4 cables**

107942	M-GD 20-4.1 LIGHT GREY UL94 V-0	M20	Ø20.5mm	1-4mm
--------	------------------------------------	-----	---------	-------

M-GD 20-5	Art. No.	Description	Cut-out	Cut-out Ø	Plate thickness
-----------	----------	-------------	---------	-----------	-----------------



**Material:** TPE  
**Colour:** Light grey  
**Dimensions:** 32.2 x 13mm  
**Flammability classification:** UL94 V-0  
**Degree of protection:** IP65  
**Installation range (Ø):** 1 x 1mm - 10,6mm  
 2 x 1mm - 4,6mm  
 2 x 1mm - 3,6mm  
**Total of 5 cables**

107943	M-GD 20-5 LIGHT GREY UL94 V-0	M20	Ø20.5mm	1-4mm
--------	----------------------------------	-----	---------	-------





## Cable Entry Plates M-GD

M-GD 20-9	Art. No.	Description	Cut-out	Cut-out Ø	Plate thickness
-----------	----------	-------------	---------	-----------	-----------------



**Material:** TPE  
**Colour:** Light grey  
**Dimensions:** 32.2 x 13mm  
**Flammability classification:** UL94 V-0  
**Degree of protection:** IP65  
**Installation range (Ø):**  
 5 x 1mm - 4,6mm  
 4 x 1mm - 3,6mm  
**Total of 9 cables**

107944	M-GD 20-9 LIGHT GREY UL94 V-0	M20	Ø20.5mm	1-4mm
--------	-------------------------------	-----	---------	-------

M-GD 25-4	Art. No.	Description	Cut-out	Cut-out Ø	Plate thickness
-----------	----------	-------------	---------	-----------	-----------------



**Material:** TPE  
**Colour:** Light grey  
**Dimensions:** 37.2 x 13mm  
**Flammability classification:** UL94 V-0  
**Degree of protection:** IP65  
**Installation range (Ø):**  
 4 x 1mm - 8mm  
**Total of 4 cables**

107945	M-GD 25-4 LIGHT GREY UL94 V-0	M25	Ø25.5mm	1-4mm
--------	-------------------------------	-----	---------	-------

M-GD 25-6	Art. No.	Description	Cut-out	Cut-out Ø	Plate thickness
-----------	----------	-------------	---------	-----------	-----------------



**Material:** TPE  
**Colour:** Light grey  
**Dimensions:** 37.2 x 13mm  
**Flammability classification:** UL94 V-0  
**Degree of protection:** IP65  
**Installation range (Ø):**  
 4 x 1mm - 5,2 mm  
 2 x 1mm - 9,4 mm  
**Total of 6 cables**

107946	M-GD 25-6 LIGHT GREY UL94 V-0	M25	Ø25.5mm	1-4mm
--------	-------------------------------	-----	---------	-------



## Cable Entry Plates M-GD

M-GD 25-7	Art. No.	Description	Cut-out	Cut-out Ø	Plate thickness
-----------	----------	-------------	---------	-----------	-----------------



**Material:** TPE  
**Colour:** Light grey  
**Dimensions:** 37.2 x 13mm  
**Flammability classification:** UL94 V-0  
**Degree of protection:** IP65  
**Installation range (Ø):**  
 7 x 1mm - 5,5 mm  
**Total of 7 cables**

107947	M-GD 25-7 LIGHT GREY UL94 V-0	M25	Ø25.5mm	1-4mm
--------	-------------------------------	-----	---------	-------

M-GD 32-7	Art. No.	Description	Cut-out	Cut-out Ø	Plate thickness
-----------	----------	-------------	---------	-----------	-----------------



**Material:** TPE  
**Colour:** Light grey  
**Dimensions:** 44.2 x 13mm  
**Flammability classification:** UL94 V-0  
**Degree of protection:** IP65  
**Installation range (Ø):**  
 7 x 1mm - 8 mm  
**Total of 7 cables**

107948	M-GD 32-7 LIGHT GREY UL94 V-0	M32	Ø32.5mm	1-4mm
--------	-------------------------------	-----	---------	-------

M-GD 32-10	Art. No.	Description	Cut-out	Cut-out Ø	Plate thickness
------------	----------	-------------	---------	-----------	-----------------



**Material:** TPE  
**Colour:** Light grey  
**Dimensions:** 44.2 x 13mm  
**Flammability classification:** UL94 V-0  
**Degree of protection:** IP65  
**Installation range (Ø):**  
 6 x 1mm - 5,2 mm  
 2 x 1mm - 6,4 mm  
 2 x 1mm - 9,4 mm  
**Total of 10 cables**

107949	M-GD 32-10 LIGHT GREY UL94 V-0	M32	Ø32.5mm	1-4mm
--------	--------------------------------	-----	---------	-------





IP65  
EN 60529

REACH  
COMPLIANT - COMPLIANT

RoHS  
Compliant

## Cable Entry Plates M-GD

M-GD 32-10.2	Art. No.	Description	Cut-out	Cut-out Ø	Plate thickness
 <p><b>Material:</b> TPE <b>Colour:</b> Light grey <b>Dimensions:</b> 44.2 x 13mm <b>Flammability classification:</b> UL94 V-0 <b>Degree of protection:</b> IP65 <b>Installation range (Ø):</b> 10 x 1mm - 6,4 mm <b>Total of 10 cables</b></p>	107950	M-GD 32-10.2 LIGHT GREY UL94 V-0	M32	Ø32.5mm	1-4mm

M-GD 32-11	Art. No.	Description	Cut-out	Cut-out Ø	Plate thickness
 <p><b>Material:</b> TPE <b>Colour:</b> Light grey <b>Dimensions:</b> 44.2 x 13mm <b>Flammability classification:</b> UL94 V-0 <b>Degree of protection:</b> IP65 <b>Installation range (Ø):</b> 2 x 1mm - 8 mm 9 x 1mm - 5,2 mm <b>Total of 11 cables</b></p>	107951	M-GD 32-11 LIGHT GREY UL94 V-0	M32	Ø20.5mm	1-4mm

M-GD 32-13	Art. No.	Description	Cut-out	Cut-out Ø	Plate thickness
 <p><b>Material:</b> TPE <b>Colour:</b> Light grey <b>Dimensions:</b> 44.2 x 13mm <b>Flammability classification:</b> UL94 V-0 <b>Degree of protection:</b> IP65 <b>Installation range (Ø):</b> 13 x 1mm - 5,2 mm <b>Total of 13 cables</b></p>	107952	M-GD 32-13 LIGHT GREY UL94 V-0	M32	Ø32.5mm	1-4mm





IP65  
EN 60529

REACH  
COMPLIANT - COMPLIANT

RoHS  
Compliant

## Cable Entry Plates M-GD

M-GD 40-9	Art. No.	Description	Cut-out	Cut-out Ø	Plate thickness
 <p><b>Material:</b> TPE <b>Colour:</b> Light grey <b>Dimensions:</b> 52.2 x 13mm <b>Flammability classification:</b> UL94 V-0 <b>Degree of protection:</b> IP65 <b>Installation range (Ø):</b> 8 x 1mm - 9,5mm 1 x 1mm - 11,3mm <b>Total of 9 cables</b></p>	107953	M-GD 40-9 LIGHT GREY UL94 V-0	M40	Ø40.5mm	1-4mm

M-GD 40-16	Art. No.	Description	Cut-out	Cut-out Ø	Plate thickness
 <p><b>Material:</b> TPE <b>Colour:</b> Light grey <b>Dimensions:</b> 52.2 x 13mm <b>Flammability classification:</b> UL94 V-0 <b>Degree of protection:</b> IP65 <b>Installation range (Ø):</b> 2 x 1mm - 5,3 mm 10 x 1mm - 6,3 mm 2 x 1mm - 9,5 mm 2 x 1mm - 11,3 mm <b>Total of 16 cables</b></p>	107954	M-GD 40-16 LIGHT GREY UL94 V-0	M40	Ø40.5mm	1-4mm

M-GD 40-17	Art. No.	Description	Cut-out	Cut-out Ø	Plate thickness
 <p><b>Material:</b> TPE <b>Colour:</b> Light grey <b>Dimensions:</b> 52.2 x 13mm <b>Flammability classification:</b> UL94 V-0 <b>Degree of protection:</b> IP65 <b>Installation range (Ø):</b> 1 x 1mm - 4 mm 16 x 1mm - 7,2 mm <b>Total of 17 cables</b></p>	107955	M-GD 40-17 LIGHT GREY UL94 V-0	M40	Ø40.5mm	1-4mm





## Cable Entry Plates M-GD

M-GD 50-9	Art. No.	Description	Cut-out	Cut-out Ø	Plate thickness
 <p><b>Material:</b> TPE <b>Colour:</b> Light grey <b>Dimensions:</b> 62.2 x 13mm <b>Flammability classification:</b> UL94 V-0 <b>Degree of protection:</b> IP65 <b>Installation range (Ø):</b> 5 x 1mm - 7 mm 4 x 1mm - 18 mm <b>Total of 9 cables</b></p>	107956	M-GD 50-9 LIGHT GREY UL94 V-0	M50	Ø50.5mm	1-4mm

M-GD 50-11	Art. No.	Description	Cut-out	Cut-out Ø	Plate thickness
 <p><b>Material:</b> TPE <b>Colour:</b> Light grey <b>Dimensions:</b> 62.2 x 13mm <b>Flammability classification:</b> UL94 V-0 <b>Degree of protection:</b> IP65 <b>Installation range (Ø):</b> 7 x 1mm - 7,2 mm 3 x 1mm - 11,2 mm 1 x 1mm - 22,5 mm <b>Total of 11 cables</b></p>	107957	M-GD 50-11 LIGHT GREY UL94 V-0	M50	Ø50.5mm	1-4mm

M-GD 50-12	Art. No.	Description	Cut-out	Cut-out Ø	Plate thickness
 <p><b>Material:</b> TPE <b>Colour:</b> Light grey <b>Dimensions:</b> 62.2 x 13mm <b>Flammability classification:</b> UL94 V-0 <b>Degree of protection:</b> IP65 <b>Installation range (Ø):</b> 10 x 1mm - 9,2 mm 2 x 1mm - 11,2 mm <b>Total of 12 cables</b></p>	107958	M-GD 50-12 LIGHT GREY UL94 V-0	M50	Ø50.5mm	1-4mm



## Cable Entry Plates M-GD

M-GD 50-16	Art. No.	Description	Cut-out	Cut-out Ø	Plate thickness
 <p><b>Material:</b> TPE <b>Colour:</b> Light grey <b>Dimensions:</b> 62.2 x 13mm <b>Flammability classification:</b> UL94 V-0 <b>Degree of protection:</b> IP65 <b>Installation range (Ø):</b> 4 x 1mm - 5,3 mm 5 x 1mm - 6,3 mm 3 x 1mm - 9,5 mm 4 x 1mm - 11,3 mm <b>Total of 16 cables</b></p>	107959	M-GD 50-16 LIGHT GREY UL94 V-0	M50	Ø50.5mm	1-4mm

M-GD 50-18	Art. No.	Description	Cut-out	Cut-out Ø	Plate thickness
 <p><b>Material:</b> TPE <b>Colour:</b> Light grey <b>Dimensions:</b> 62.2 x 13mm <b>Flammability classification:</b> UL94 V-0 <b>Degree of protection:</b> IP65 <b>Installation range (Ø):</b> 2 x 1mm - 4 mm 2 x 1mm - 6 mm 4 x 1mm - 7,2 mm 5 x 1mm - 9,4 mm 5 x 1mm - 12 mm <b>Total of 18 cables</b></p>	107960	M-GD 50-18 LIGHT GREY UL94 V-0	M50	Ø50.5mm	1-4mm

M-GD 50-20	Art. No.	Description	Cut-out	Cut-out Ø	Plate thickness
 <p><b>Material:</b> TPE <b>Colour:</b> Light grey <b>Dimensions:</b> 62.2 x 13mm <b>Flammability classification:</b> UL94 V-0 <b>Degree of protection:</b> IP65 <b>Installation range (Ø):</b> 16 x 1mm - 6,5mm 4 x 1mm - 9,5mm <b>Total of 20 cables</b></p>	107961	M-GD 50-20 LIGHT GREY UL94 V-0	M50	Ø50.5mm	1-4mm



**IP65**  
EN 60529

**RoHS**  
Compliant

## Cable Entry Plates M-GD

M-GD 50-35	Art. No.	Description	Cut-out	Cut-out Ø	Plate thickness
------------	----------	-------------	---------	-----------	-----------------



**Material:** TPE  
**Colour:** Light grey  
**Dimensions:** 62.2 x 13mm  
**Flammability classification:** UL94 V-0  
**Degree of protection:** IP65  
**Installation range (Ø):** 35 x 1mm - 5,2 mm  
**Total of 35 cables**

107962	M-GD 50-35 LIGHT GREY UL94 V-0	M50	Ø50.5mm	1-4mm
--------	--------------------------------	-----	---------	-------

CABLE / TUBE DIAMETER	M-GD 20-4	M-GD 20-4.1	M-GD 20-5	M-GD 20-9	M-GD 25-4	M-GD 25-6	M-GD 25-7	M-GD 32-7	M-GD 32-10	M-GD 32-10.2	M-GD 32-11	M-GD 32-13	M-GD 40-9	M-GD 40-16	M-GD 40-17	M-GD 50-9	M-GD 50-11	M-GD 50-12	M-GD 50-16	M-GD 50-18	M-GD 50-20	M-GD 50-35	
1-3.6mm			2	4																			
1-4mm															1						2		
1-4.5mm		2																					
1-4.6mm			2	5																			
1-5.2mm	4					4	7		6		9	13											35
1-5.3mm															2						4		
1-6mm																					2		
1-6.3mm															10						5		16
1-6.4mm									2	10													
1-7mm																	5						
1-7.2mm															16		7				4		
1-8mm		2			4			7		2													
1-9.2mm																			10				
1-9.3mm																							4
1-9.4mm						2			2													5	
1-9.5mm													8	2								3	
1-10.6mm			1																				
1-11.2mm																	3	2					
1-11.3mm													1	2							4		
1-12mm																							5
1-18mm																4							
1-22.5 mm																	1						



# Cable Entry Plates FL21

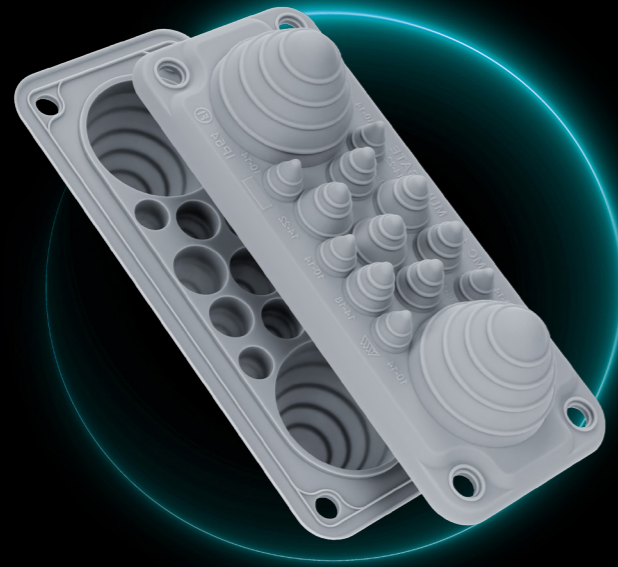

The FL21, often identified as the C size cut-out, is extensively utilized, particularly in northern Europe. A zinc-coated steel metal insert is employed to fortify the structure. These membrane-based cable entry plates are purposefully crafted for use with cables lacking connectors, as well as tubes, and pneumatic or hydraulic hoses, providing a versatile and durable solution.

### Advantages

- Fast and easy assembly
- High cable density
- Double sealing with excellent IP protection
- Suitable for both indoor and outdoor use

### Technical Specifications

- Material: thermoplastic elastomer
- Material properties: UL94 V-0
- Material reinforcement: zinc coated steel
- Colour: light grey and black
- Material service temperature (unstressed): -40°C...+100°C
- Non-UL material versions available on request

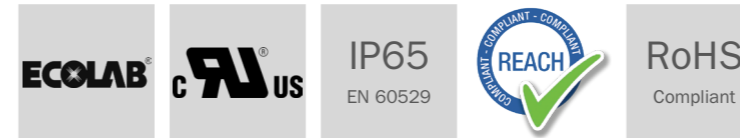

## Cable Entry Plates for FL21 cut-out

MC3	Art. No.	Description	Box size	Packing
 <p><b>Dimensions:</b> 214 x 84 x 37mm</p> <p><b>Flammability classification:</b> UL94 V-0</p> <p><b>Degree of protection:</b> IP65</p> <p><b>Installation range (Ø):</b> 4 x 8mm - 12mm 2 x 24mm - 54mm 1 x 30mm - 60mm <b>Total of 7 cables</b></p>	100235	MC3 BLACK UL94 V-0	100	Bulk
	100235B	MC3 BLACK UL94 V-0	80	Single
	107610	MC3 LIGHT GREY UL94 V-0	100	Bulk
	107610B	MC3 LIGHT GREY UL94 V-0	80	Single

MC25	Art. No.	Description	Box size	Packing
 <p><b>Dimensions:</b> 216 x 84 x 24mm</p> <p><b>Flammability classification:</b> UL94 V-0</p> <p><b>Degree of protection:</b> IP65</p> <p><b>Installation range (Ø):</b> 4 x 5mm - 7mm 4 x 8mm - 12mm 12 x 10mm - 14mm 4 x 14mm - 22mm 1 x 20mm - 26mm <b>Total of 25 cables</b></p>	100239	MC25 BLACK UL94 V-0	100	Bulk
	100239B	MC25 BLACK UL94 V-0	80	Single
	107611	MC25 LIGHT GREY UL94 V-0	100	Bulk
	107611B	MC25 LIGHT GREY UL94 V-0	80	Single

MC35	Art. No.	Description	Box size	Packing
 <p><b>Dimensions:</b> 216 x 84 x 31mm</p> <p><b>Flammability classification:</b> UL94 V-0</p> <p><b>Degree of protection:</b> IP65</p> <p><b>Installation range (Ø):</b> 2 x 6mm - 10mm 14 x 7mm - 12mm 16 x 10mm - 14mm 2 x 12mm - 18mm 1 x 17mm - 32mm <b>Total of 35 cables</b></p>	100245	MC35 BLACK UL94 V-0	100	Bulk
	100245B	MC35 BLACK UL94 V-0	80	Single
	107612	MC35 LIGHT GREY UL94 V-0	100	Bulk
	107612B	MC35 LIGHT GREY UL94 V-0	80	Single

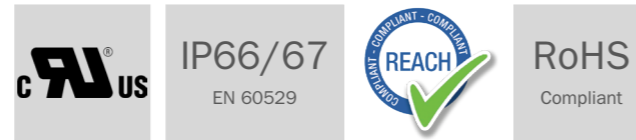

## Cable Entry Plates for FL21 cut-out

MC3/7	Art. No.	Description	Box size	Packing
 <p><b>Dimensions:</b> 222 x 92 x 76mm</p> <p><b>Flammability classification:</b> UL94 V-0</p> <p><b>Degree of protection:</b> IP66/67</p> <p><b>Installation range (Ø):</b> 2 x 24mm - 54mm 1 x 30mm - 60mm 4 x 10mm - 14mm <b>Total of 7 cables</b></p>	105041	MC3/7 LIGHT GREY UL94 V-0	60	Bulk
	105041B	MC3/7 LIGHT GREY UL94 V-0	40	Single
	103580	MC3/7 BLACK UL94 V-0	60	Bulk
	103580B	MC3/7 BLACK UL94 V-0	40	Single

MC25/27	Art. No.	Description	Box size	Packing
 <p><b>Dimensions:</b> 222 x 92 x 43mm</p> <p><b>Flammability classification:</b> UL94 V-0</p> <p><b>Degree of protection:</b> IP66/67</p> <p><b>Installation range (Ø):</b> 4 x 5mm - 7mm 4 x 8mm - 12mm 13 x 10mm - 14mm 4 x 14mm - 20mm 2 x 20mm - 26mm <b>Total of 27 cables</b></p>	105042	MC25/27 LIGHT GREY UL94 V-0	60	Bulk
	105042B	MC25/27 LIGHT GREY UL94 V-0	40	Single
	103586	MC25/27 BLACK UL94 V-0	60	Bulk
	103586B	MC25/27 BLACK UL94 V-0	40	Single

MC35/37	Art. No.	Description	Box size	Packing
 <p><b>Dimensions:</b> 222 x 92 x 43mm</p> <p><b>Flammability classification:</b> UL94 V-0</p> <p><b>Degree of protection:</b> IP66/67</p> <p><b>Installation range (Ø):</b> 4 x 6mm - 10mm 14 x 8mm - 12mm 16 x 10mm - 14mm 2 x 12mm - 18mm 1 x 17mm - 32mm <b>Total of 37 cables</b></p>	105043	MC35/37 LIGHT GREY UL94 V-0	60	Bulk
	105043B	MC35/37 LIGHT GREY UL94 V-0	40	Single
	103591	MC35/37 BLACK UL94 V-0	60	Bulk
	103591B	MC35/37 BLACK UL94 V-0	40	Single

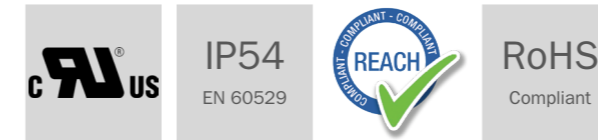

## Cable Entry Plates for FL21 cut-out

LMC 14	Art. No.	Description	Box size	Packing
 <p><b>Dimensions:</b> 222 x 92 x 52mm</p> <p><b>Flammability classification:</b> UL94 V-0</p> <p><b>Degree of protection:</b> IP54</p> <p><b>Installation range (Ø):</b> 5 x 10mm - 14mm 4 x 14mm - 18mm 3 x 14mm - 22mm 2 x 24mm - 54mm <b>Total of 14 cables</b></p>	104338	LMC 14 LIGHT GREY UL94 V-0	100	Bulk
	104338B	LMC 14 LIGHT GREY UL94 V-0	40	Single

LMC 25	Art. No.	Description	Box size	Packing
 <p><b>Dimensions:</b> 222 x 92 x 30mm</p> <p><b>Flammability classification:</b> UL94 V-0</p> <p><b>Degree of protection:</b> IP54</p> <p><b>Installation range (Ø):</b> 2 x 3mm - 11mm 5 x 10mm - 14mm 12 x 14mm - 18mm 5 x 14mm - 22mm 1 x 14mm - 35mm <b>Total of 25 cables</b></p>	104335	LMC 25 LIGHT GREY UL94 V-0	100	Bulk
	104335B	LMC 25 LIGHT GREY UL94 V-0	40	Single

LMC 51	Art. No.	Description	Box size	Packing
 <p><b>Dimensions:</b> 222 x 92 x 30mm</p> <p><b>Flammability classification:</b> UL94 V-0</p> <p><b>Degree of protection:</b> IP54</p> <p><b>Installation range (Ø):</b> 50 x 7mm - 13mm 1 x 15mm - 25mm <b>Total of 51 cables</b></p>	104344	LMC 51 LIGHT GREY UL94 V-0	100	Bulk
	104344B	LMC 51 LIGHT GREY UL94 V-0	40	Single







IP44 EN 60529	IP54 EN 60529	IP55 EN 60529	REACH Compliant	RoHS Compliant
------------------	------------------	------------------	--------------------	-------------------

## Cable Entry Plates for FL21 cut-out

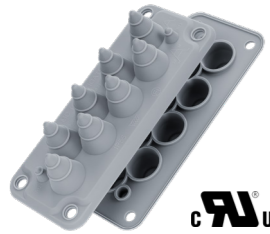
LMC 35	Art. No.	Description	Box size	Packing
 <p><b>Dimensions:</b> 214 x 84 x 9,5mm</p> <p><b>Degree of protection:</b> IP44</p> <p><b>Installation range (∅):</b> 2 x 6mm - 10mm 14 x 7mm - 12mm 16 x 10mm - 14mm 2 x 12mm - 18mm 1 x 15mm - 32mm <b>Total of 35 cables</b></p>	100241	LMC 35 LIGHT GREY	100	Bulk
	100241B	LMC 35 LIGHT GREY	80	Single

MC 10	Art. No.	Description	Box size	Packing
 <p><b>Dimensions:</b> 216 x 84 x 48mm</p> <p><b>Flammability classification:</b> UL94 V-0</p> <p><b>Degree of protection:</b> IP55</p> <p><b>Installation range (∅):</b> 2 x 7mm - 12mm 8 x 10mm - 30mm <b>Total of 10 cables</b></p>	103552	MC 10 LIGHT GREY UL94 V-0	100	Bulk
	103552B	MC 10 LIGHT GREY UL94 V-0	50	Single

MC 16	Art. No.	Description	Box size	Packing
 <p><b>Dimensions:</b> 216 x 84 x 31mm</p> <p><b>Degree of protection:</b> IP54</p> <p><b>Installation range (∅):</b> 15 x 10mm - 20mm 1 x 10mm - 30mm <b>Total of 16 cables</b></p>	100084	MC 16 LIGHT GREY	100	Bulk
	100084B	MC 16 LIGHT GREY	80	Single

IP65 EN 60529	REACH Compliant	RoHS Compliant
------------------	--------------------	-------------------



## Cable Entry Plates for FL21 cut-out RMC

Reinforced plastic insert is made robust, yet lightweight. These membrane-based cable entry plates are designed to be used with cables without connectors, tubes and pneumatic or hydraulic hoses.

### RMC Advantages

- Sealing rings can easily be pulled off without extra tools to make RMC perfectly fit various cable sizes making the installation very fast

### RMC Technical Specifications

- Material: thermoplastic elastomer and fiberglass reinforced plastic
- Material Properties: UL94 V-0
- Colour: black and light grey
- Standard M8 bolts used for mounting
- Material service temperature (unstressed): -40°C...+90°C

RMC 3	Art. No.	Description	Box size	Packing
 <p><b>Dimensions:</b> 220 x 88 x 25,5mm</p> <p><b>Flammability classification:</b> UL94 V-0</p> <p><b>Degree of protection:</b> IP65</p> <p><b>Installation range (∅):</b> 4 x 7mm - 10mm 3 x 12mm - 57mm <b>Total of 7 cables</b></p>	107360	RMC 3 LIGHT GREY UL94 V-0	100	Bulk
	107444	RMC 3 BLACK UL94 V-0	100	Bulk

RMC 17	Art. No.	Description	Box size	Packing
 <p><b>Dimensions:</b> 220 x 88 x 25,5mm</p> <p><b>Flammability classification:</b> UL94 V-0</p> <p><b>Degree of protection:</b> IP65</p> <p><b>Installation range (∅):</b> 4 x 5mm - 7mm 2 x 10mm - 12mm 2 x 12mm - 15mm 9 x 10mm - 30mm <b>Total of 17 cables</b></p>	108424	RMC 17 LIGHT GREY UL94 V-0	100	Bulk
	106998	RMC 17 BLACK UL94 V-0	100	Bulk

# Cable Entry Plates FL13



The specified cut-out size finds prevalent use, particularly in northern Europe, where FL13 is commonly recognized as the B size cut-out. A zinc-coated steel metal insert is incorporated to enhance structural strength. These membrane-based cable entry plates are meticulously designed for compatibility with cables lacking connectors, as well as tubes, pneumatic, or hydraulic hoses, offering a versatile solution for various applications.

### Advantages

- Fast and easy assembly
- High cable density
- Screw mounting
- Suitable for both indoor and outdoor use

### Technical Specifications

- Material: thermoplastic elastomer (TPE)
- Material properties: UL94 V-0
- Material reinforcement: zinc coated steel
- Colour: light grey
- Material service temperature (unstressed): -40°C...+100°C
- Non-UL material versions available on request

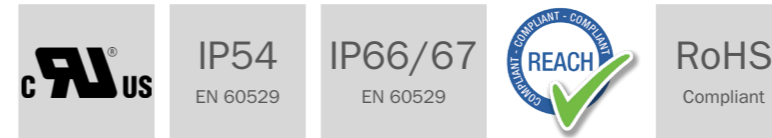

## Cable Entry Plates for FL13 cut-out

MB 4/10	Art. No.	Description	Box size	Packing
---------	----------	-------------	----------	---------



**Dimensions:**  
147 x 57 x 31mm

**Flammability classification:**  
UL94 V-0

**Degree of protection:**  
IP54

**Installation range (Ø):**  
6 x 4mm - 9mm  
4 x 10mm - 25mm  
**Total of 10 cables**

105954	MB 4/10 LIGHT GREY UL94 V-0	200	Bulk
--------	--------------------------------	-----	------

MB 5/11	Art. No.	Description	Box size	Packing
---------	----------	-------------	----------	---------



**Dimensions:**  
147 x 57 x 42mm

**Flammability classification:**  
UL94 V-0

**Degree of protection:**  
IP66/67

**Installation range (Ø):**  
4 x 5mm - 7mm  
3 x 7mm - 10mm  
2 x 10mm - 14mm  
2 x 15mm - 30mm  
**Total of 11 cables**

105044	MB 5/11 LIGHT GREY UL94 V-0	200	Bulk
--------	--------------------------------	-----	------

105044B	MB 5/11 LIGHT GREY UL94 V-0	100	Single
---------	--------------------------------	-----	--------



# Cable Entry Plates Special cut-out



### Advantages

- Fast and easy assembly
- High cable density
- Double sealing with high IP protection
- Suitable for both indoor and outdoor use

### Technical Specifications

- Material: thermoplastic elastomer
- Material properties: UL94 V-0
- Material reinforcement: stainless steel
- Colour: black
- Material service temperature (unstressed): -40°C...+100°C



## Cable Entry Plates for Special cut-out

MC 4	Art. No.	Description	Box size	Packing
------	----------	-------------	----------	---------



**Dimensions:**  
300 x 88 x 36mm

**Flammability classification:**  
UL94 V-0

**Degree of protection:**  
IP65

**Installation range (∅):**  
4 x 30mm - 63mm  
**Total of 4 cables**

103888

MC 4x30 - 63 BLACK  
UL94 V-0

50

Bulk

MC 1/3	Art. No.	Description	Box size	Packing
--------	----------	-------------	----------	---------

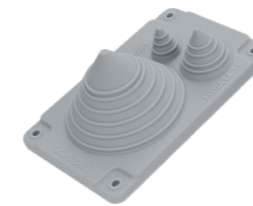

**Material:**  
TPE

**Dimensions:**  
155,6 x 100x 91mm

**Cut-out dimensions:**  
130 x 88mm

**Flammability classification:**  
UL94 V-0

**Degree of protection:**  
IP66

**Installation range (∅):**  
1 x 35mm - 80mm  
1 x 14mm - 32mm  
1 x 8mm -18mm  
**Total of 3 cables**

W500426

MC 1/3 SOLAR LIGHT GREY  
UL94 V-0

60

Bulk

# Splitting Entry Systems

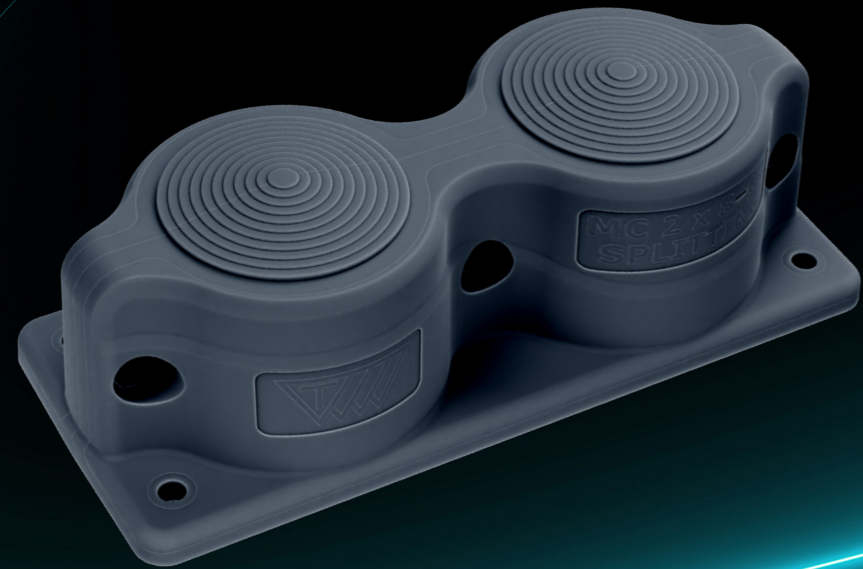

Introducing Splitting Entry Systems: Frequently, cables are equipped with connectors that cannot be detached and reattached. Trelleborg's splitting multigates offer a solution that enables the installation of cables with their connectors intact. Additionally, this innovative system allows for the flexibility to change cables as frequently as desired.

## Advantages

- Can be used with pre-determined cables
- Robust design
- Good strain relief
- Suitable for both indoor and outdoor use

## Technical Specifications

- Material: thermoplastic elastomer and fiberglass reinforced plastic
- Material properties: UL94 V-0
- Colour: black
- Material service temperature (unstressed): -40°C...+100°C
- Non-UL material versions available on request

IP66  
EN 60529



RoHS  
Compliant



## Splitting Entry Systems IP66

MC 1x10-65	Art. No.	Description	Box size	Packing
 <p><b>Material:</b> halogen-free Membrane: TPE</p> <p><b>Material temperature range:</b> -40...+100°C</p> <p><b>Dimensions:</b> 123 x 92 x 75mm</p> <p><b>Flammability classification:</b> UL94 V-0</p> <p><b>Degree of protection:</b> IP66</p> <p><b>Installation range (Ø):</b> 10mm - 65mm <b>Total of 1 cables</b></p>	107917	MC 1x10-65 SPLITTING ENTRY UL94 V-0	20	Bulk

MC 2x10-65	Art. No.	Description	Box size	Packing
 <p><b>Material:</b> halogen-free Membrane: TPE</p> <p><b>Material temperature range:</b> -40...+100°C</p> <p><b>Dimensions:</b> 123 x 92 x 75mm</p> <p><b>Flammability classification:</b> UL94 V-0</p> <p><b>Degree of protection:</b> IP66</p> <p><b>Installation range (Ø):</b> 10mm - 65mm <b>Total of 2 cables</b></p>	107918	MC 2x10-65 SPLITTING ENTRY UL94 V-0	10	Bulk





## Splitting Entry Systems IP55

MC 1x8-67	Art. No.	Description	Box size	Packing
-----------	----------	-------------	----------	---------



**Dimensions:**  
123 x 92 x 75mm

**Flammability classification:**  
UL94 V-0

**Degree of protection:**  
IP55

**Installation range (∅):**  
2 x 8mm - 67mm  
**Total of 1 cables**

106582	MC 1x8-67 UL94 V-0	20	Bulk
--------	-----------------------	----	------

MC 2x8-67	Art. No.	Description	Box size	Packing
-----------	----------	-------------	----------	---------



**Dimensions:**  
222 x 92 x 75mm

**Flammability classification:**  
UL94 V-0

**Degree of protection:**  
IP55

**Installation range (∅):**  
2 x 8mm - 67mm  
**Total of 2 cables**

100074	MC 2x8-67 UL94 V-0	10	Bulk
--------	-----------------------	----	------

MC 1/9	Art. No.	Description	Box size	Packing
--------	----------	-------------	----------	---------



**Dimensions:**  
123 x 93 x 81mm

**Flammability classification:**  
UL94 V-0

**Degree of protection:**  
IP55

**Installation range (∅):**  
4 x 5mm - 11 & 13mm  
**Total of 9 cables**

106825	MC 1/9 SPLITTING UL94 V-0	20	Bulk
--------	------------------------------	----	------

MC 2/10	Art. No.	Description	Box size	Packing
---------	----------	-------------	----------	---------



**Dimensions:**  
222 x 92 x 84mm

**Flammability classification:**  
UL94 V-0

**Degree of protection:**  
IP55

**Installation range (∅):**  
5 x 1mm - 14mm  
2 x 5mm - 11mm  
2 x 5mm - 13mm  
1 x 8mm - 67mm  
**Total of 10 cables**

106618	MC 2/10 SPLITTING UL94 V-0	10	Bulk
--------	-------------------------------	----	------



## Splitting Entry Systems IP55

SCG 1x3-35	Art. No.	Description	Box size	Packing
------------	----------	-------------	----------	---------



**Dimensions:**  
77 x 60 x 40mm

**Flammability classification:**  
UL94 V-0

**Degree of protection:**  
IP55

**Installation range (∅):**  
2 x 3mm - 35mm  
**Total of 1 cables**

105928	SCG 1x3-35 UL94 V-0	100	Bulk
--------	------------------------	-----	------

SCG 2x3-35	Art. No.	Description	Box size	Packing
------------	----------	-------------	----------	---------



**Dimensions:**  
136 x 60 x 40mm

**Flammability classification:**  
UL94 V-0

**Degree of protection:**  
IP55

**Installation range (∅):**  
2 x 3mm - 35mm  
**Total of 2 cables**

105929	SCG 2x3-35 UL94 V-0	50	Bulk
--------	------------------------	----	------

SCG 6x3-20	Art. No.	Description	Box size	Packing
------------	----------	-------------	----------	---------



**Dimensions:**  
220 x 60 x 40mm

**Flammability classification:**  
UL94 V-0

**Degree of protection:**  
IP55

**Installation range (∅):**  
6 x 3mm - 20mm  
**Total of 6 cables**

W500305	SCG 6x3-20	20	Bulk
---------	------------	----	------

# Modular System

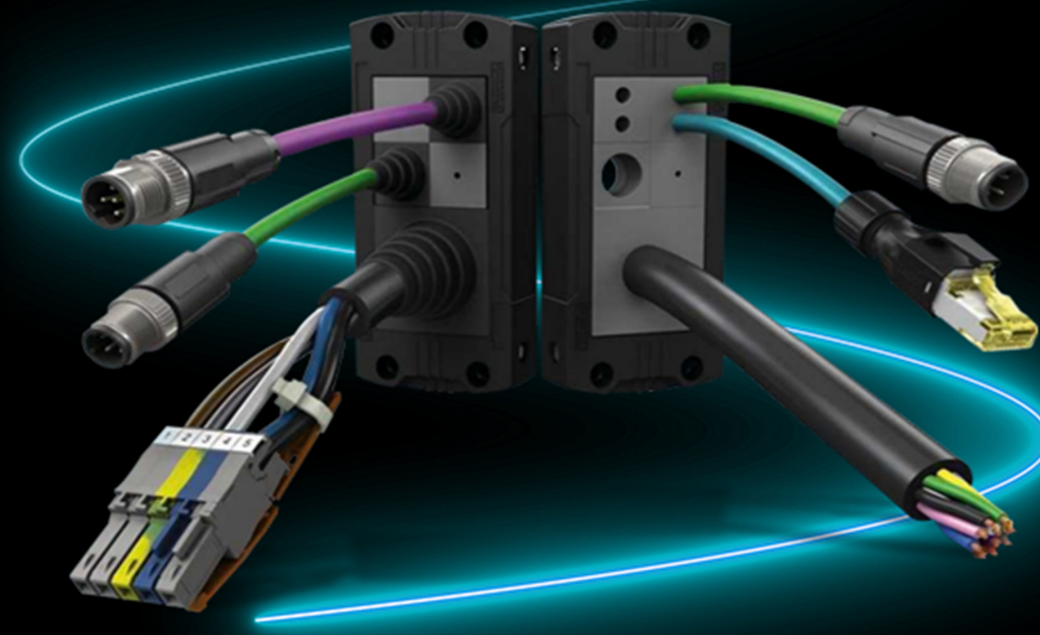

With more than 1,000 possible configurations, we achieve ideal solutions for your applications in order to realize the cable infrastructure more flexible and durable. With our combinable variable system you can mount assembled as well as unassembled cables or pneumatic hoses quickly and flexibly. The individual elements are available in a variety of shapes and for a wide range of cable diameters. The cable seals are very robust and provide a reliable seal up to protection class IP65.

## Advantages

- Saves space due to plug connection into the inside
- Easy handling: no special tools required
- High level of safety thanks to robust and oil-resistant designs
- Reliable sealing with strain relief according to DIN EN 62444
- Extensive product range - designs for various applications
- High vibration-proof dimensional stability of the plastic frames due to metal inserts
- Guarantee retaining for pre-assembled cables
- Flexible retrofits, highest available cable density with extensive variability
- The Cutouts of the designs correspond to the standard of industry connectors requirements

Reduce space and saves costs



Variable mounting options



Fast installation and a reliable seal



High stability, vibration-proof



Cable grommets for your needs



For pre-assembled cables



Optional locking latch



Create your own configuration



Scan QR code

<https://www.trelleborg.com/apps/ces/index.html#/configurator>





# Explore our solutions

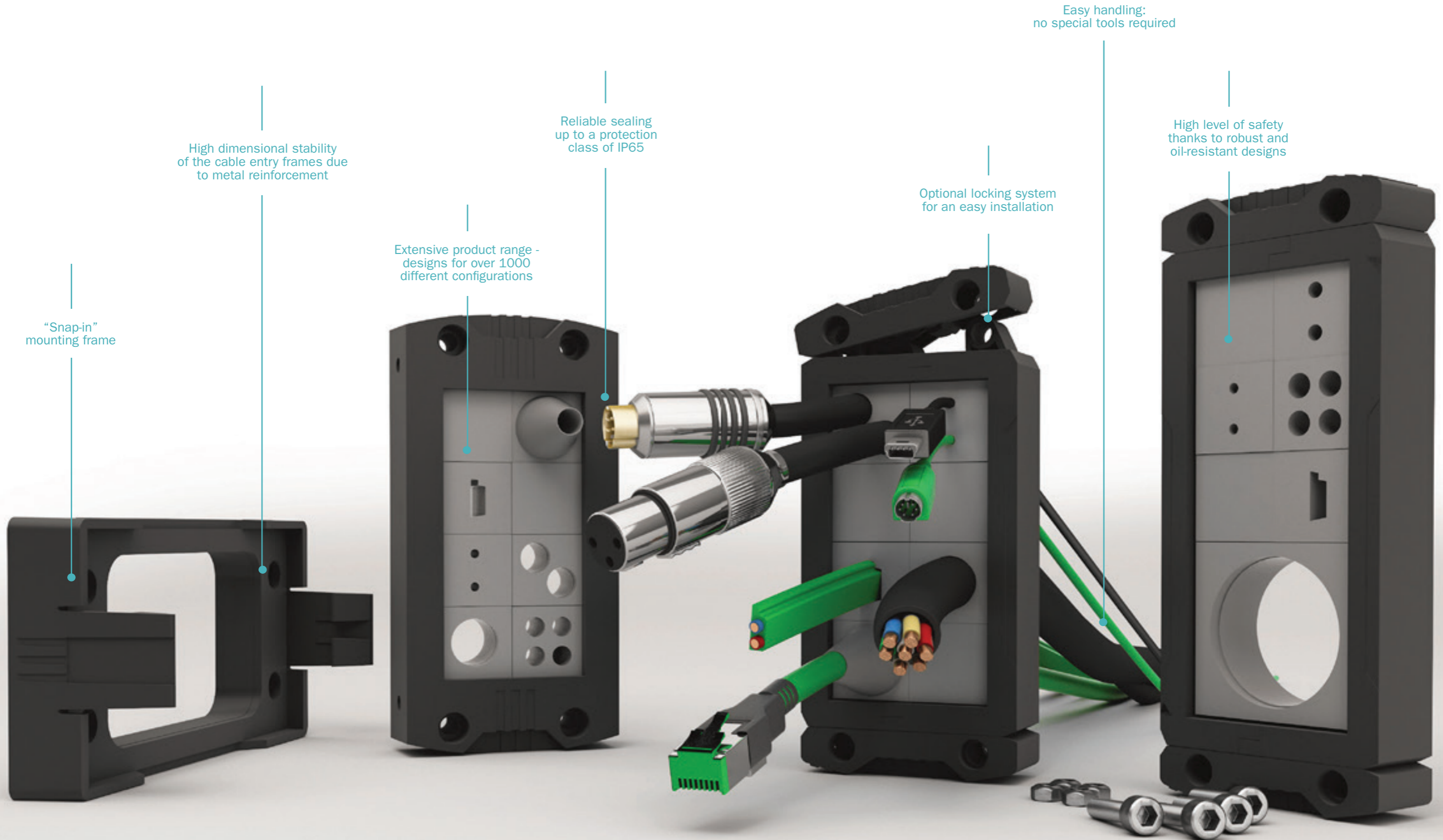



IP54 EN 60529	IP65 EN 60529	REACH COMPLIANT - COMPLIANT	RoHS Compliant
------------------	------------------	--------------------------------	-------------------

## Modular Frames

with locking latch	Cutout	Specification	Part No.
 <p><b>Material:</b> polyamide, halogen-free, silicone-free</p> <p><b>Color:</b> Black</p> <p><b>Temperature range:</b> -40...+120°C</p> <p><b>Degree of protection:</b> IP54</p> <p><b>Flammability classification:</b> UL94 V0</p>	B10 35 x 65mm	for accommodating up to 6 (small) cable grommets	107703
	B16 35 x 86mm	for accommodating up to 8 (small) cable grommets	107702
	B24 35 x 113mm	for accommodating up to 10 (small) cable grommets	107701
with screw locking	Cutout	Specification	Part No.
 <p><b>Material:</b> polyamide, halogen-free, silicone-free</p> <p><b>Color:</b> Black</p> <p><b>Temperature range:</b> 40...+120°C</p> <p><b>Degree of protection:</b> IP54/IP65</p> <p><b>Flammability classification:</b> UL94 V0</p>	B10 35 x 65mm	for accommodating up to 6 (small) cable grommets	107706
	B16 35 x 86mm	for accommodating up to 8 (small) cable grommets	107705
	B24 35 x 113mm	for accommodating up to 10 (small) cable grommets	107704
snap-in mounting frame	Cutout	Specification	Part No.
 <p><b>Material:</b> polyamide, halogen-free, silicone-free</p> <p><b>Color:</b> Black</p> <p><b>Temperature range:</b> -40...+120°C</p> <p><b>Degree of protection:</b> IP54/IP65</p> <p><b>Flammability classification:</b> UL94 V0</p>	B10 35 x 65mm	for accommodating B10 split cable entry frames, with integrated sealing	107709
	B16 35 x 86mm	for accommodating B16 split cable entry frames, with integrated sealing	107708
	B24 35 x 113mm	for accommodating B24 split cable entry frames, with integrated sealing	107707



## Accessories for Modular Cable Entry Systems

flat gasket	Cutout	Specification	Part No.	
	B10 35 x 65mm	Spare gasket for sealing frame with standard cutout B10	107934	
	B16 35 x 86mm	Spare gasket for sealing frame with standard cutout B16	107935	
	B24 35 x 113mm	Spare gasket for sealing frame with standard cutout B24	107936	
replacement screw	Specification	Part No.		
	M4 replacement locking screw, Allen screw head, for sealing frames with screw locking	107937		
EMC cable shielded rails	Specification	Part No.		
	for mounting on the long side of the sealing frame TMS-B10	107940		
	for mounting on the long side of the sealing frame TMS-B16	107938		
	for mounting on the long side of the sealing frame TMS-B24	107939		
filler plugs	Ø holes	Part No.	Ø holes	Part No.
 <p><b>Material</b> polyamide, halogen-free, silicone-free  <b>Temperature range:</b> -20...+80°C  <b>Degree of protection:</b> IP54  <b>Flammability classification</b> UL94 : V0</p>	2 mm	107901	10 mm	107915
	3 mm	107908	11 mm	107916
	4 mm	107909	12 mm	107902
	5 mm	107910	13 mm	107903
	6 mm	107911	14 mm	107904
	7 mm	107912	15 mm	107905
	8 mm	107913	16 mm	107906
	9 mm	107914	17 mm	107907





IP54  
EN 60529

IP65  
EN 60529

REACH  
COMPLIANT - COMPLIANT

RoHS  
Compliant

## Modular Grommets

without bore hole, IP65	Dimensions	Part No.	Dimensions	Part No.
-------------------------	------------	----------	------------	----------

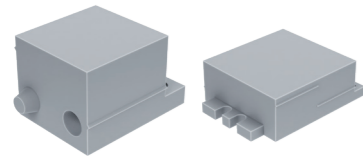

Small 29,5 x 19,5 x 17 mm	107840	Large 53 x 39 x 17 mm	107841
------------------------------	--------	--------------------------	--------

**Material:** SEBS  
**Color:** Grey  
**Temperature range:** -40...+80°C  
**Flammability classification** UL94 V0  
**Certified according to** UL 508

small, split, IP54	Ø cable	Part No.	Ø cable	Part No.
--------------------	---------	----------	---------	----------

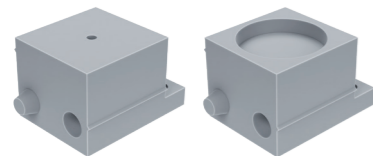

1-2mm	107801	9-10mm	107809
2-3mm	107802	10-11mm	107810
3-4mm	107803	11-12mm	107811
4-5mm	107804	12-13mm	107812
5-6mm	107805	13-14mm	107813
6-7mm	107806	14-15mm	107850
7-8mm	107807	15-16mm	107851
8-9mm	107808	16-17mm	107852

**Material:** SEBS  
**Color:** Grey  
**Dimensions:** 29,5 x 19,5 x 17 mm  
**Temperature range:** -40...+80°C  
**Flammability classification** UL94: V0

large, split, IP54	Ø cable	Part No.	Ø cable	Part No.
--------------------	---------	----------	---------	----------

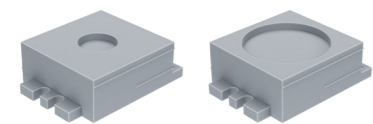

14-15mm	107814	24-25mm	107824
15-16mm	107815	25-26mm	107825
16-17mm	107816	26-27mm	107826
17-18mm	107817	27-28mm	107827
18-19mm	107818	28-29mm	107828
19-20mm	107819	29-30mm	107829
20-21mm	107820	30-31mm	107830
21-22mm	107821	31-32mm	107831
22-23mm	107822	32-33mm	107832
23-24mm	107823		

**Material:** SEBS  
**Color:** Grey  
**Dimensions:** 53 x 39 x 17 mm  
**Temperature range:** -40...+80°C  
**Flammability classification** UL94: V0



IP54  
EN 60529

REACH  
COMPLIANT - COMPLIANT

RoHS  
Compliant

## Modular Grommets

small, split, with 2 or 4 bore holes	Ø holes	Specification	Part No.
--------------------------------------	---------	---------------	----------

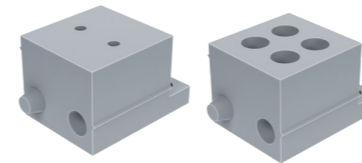

**Material:** SEBS  
**Color:** Grey  
**Dimensions:** 29,5 x 19,5 x 17 mm  
**Temperature range:** -40...+80°C  
**Flammability classification** UL94: V0

2x2-3mm	for cable outer diameter 2 x 2-3 mm	107847
2x3-4mm	for cable outer diameter 2 x 3-4 mm	107848
2x4-5mm	for cable outer diameter 2 x 4-5 mm	107833
2x5-6mm	for cable outer diameter 2 x 5-6 mm	107834
2x6-7mm	for cable outer diameter 2 x 6-7 mm	107853
2x7-8mm	for cable outer diameter 2 x 7-8 mm	107844
2x8-9mm	for cable outer diameter 2 x 8-9 mm	107849
4x2-3mm	for cable outer diameter 4 x 2-3 mm	107835
4x3-4mm	for cable outer diameter 4 x 3-4 mm	107836
4x4-5mm	for cable outer diameter 4 x 4-5 mm	107845
4x5-6mm	for cable outer diameter 4 x 5-6 mm	107846

small, split, for AS-Interface cables	Specification	Part No.
---------------------------------------	---------------	----------

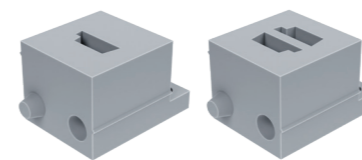

**Material:** SEBS  
**Color:** Grey  
**Dimensions:** 29,5 x 19,5 x 17 mm  
**Temperature range:** -40...+80°C  
**Flammability classification** UL94: V0

for one AS-Interface cable: R	107837
for two AS-Interface cables: LR	107839
for two AS-Interface cables: RR	107838
for one AS-Interface cable: L	107842
for two AS-Interface cables: LL	107843

# Modular Grommets

IP54 EN 60529    IP65 EN 60529    REACH COMPLIANT - COMPLIANT    RoHS Compliant    

## coned grommets, IP65

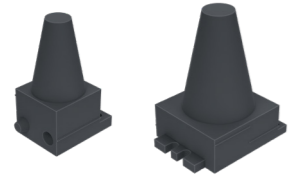

**Material:** NBR  
**Color:** Black  
**Temperature range:** -40...+125°C

Dimensions	Part No.	Dimensions	Part No.
Small 29,5 x 19,5 x 17 mm Ø cable 2-11 mm	107764	Large 53 x 39 x 17 mm Ø cable 7-24 mm	107763

## without bore hole, IP65



**Material:** NBR  
**Color:** Black  
**Temperature range:** -40...+125°C

Dimensions	Part No.	Dimensions	Part No.
Small 29,5 x 19,5 x 17 mm	107730	Large 53 x 39 x 17 mm	107762

## small, split, IP54

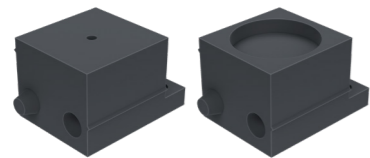

**Material:** NBR  
**Color:** Black  
**Dimensions:** 29,5 x 19,5 x 17 mm  
**Temperature range:** -40...+125°C

Ø cable	Part No.	Ø cable	Part No.
1-2mm	107722	9-10mm	107714
2-3mm	107721	10-11mm	107713
3-4mm	107720	11-12mm	107712
4-5mm	107719	12-13mm	107711
5-6mm	107718	13-14mm	107710
6-7mm	107717	14-15mm	107740
7-8mm	107716	15-16mm	107741
8-9mm	107715	16-17mm	107742

## large, split, IP54

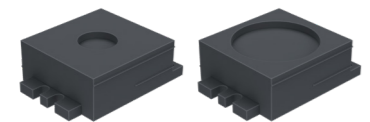

**Material:** NBR  
**Color:** Black  
**Dimensions:** 53 x 39 x 17 mm  
**Temperature range:** -40...+125°C

Ø cable	Part No.	Ø cable	Part No.
14-15mm	107743	24-25mm	107753
15-16mm	107744	25-26mm	107754
16-17mm	107745	26-27mm	107755
17-18mm	107746	27-28mm	107756
18-19mm	107747	28-29mm	107757
19-20mm	107748	29-30mm	107758
20-21mm	107749	30-31mm	107759
21-22mm	107750	31-32mm	107760
22-23mm	107751	32-33mm	107761
23-24mm	107752		

# Modular Grommets

IP54 EN 60529    REACH COMPLIANT - COMPLIANT    RoHS Compliant    

## small, split, with 2 or 4 bore holes

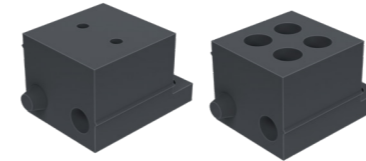

**Material:** NBR  
**Color:** Black  
**Dimensions:** 29,5 x 19,5 x 17 mm  
**Temperature range:** -40...+125°C

Ø holes	Specification	Part No.
2x2-3mm	for cable outer diameter 2 x 2-3 mm	107737
2x3-4mm	for cable outer diameter 2 x 3-4 mm	107738
2x4-5mm	for cable outer diameter 2 x 4-5 mm	107723
2x5-6mm	for cable outer diameter 2 x 5-6 mm	107724
2x6-7mm	for cable outer diameter 2 x 6-7 mm	107733
2x7-8mm	for cable outer diameter 2 x 7-8 mm	107734
2x8-9mm	for cable outer diameter 2 x 8-9 mm	107739
4x2-3mm	for cable outer diameter 4 x 2-3 mm	107725
4x3-4mm	for cable outer diameter 4 x 3-4 mm	107726
4x4-5mm	for cable outer diameter 4 x 4-5 mm	107735
4x5-6mm	for cable outer diameter 4 x 5-6 mm	107736

## small, split, for AS-Interface cables

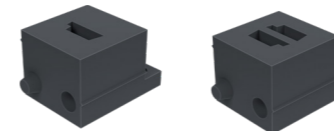

**Material:** NBR  
**Color:** Black  
**Dimensions:** 29,5 x 19,5 x 17 mm  
**Temperature range:** -40...+125°C

Specification	Part No.
for one AS-Interface cable: R	107727
for two AS-Interface cables: LR	107729
for two AS-Interface cables: RR	107728
for one AS-Interface cable: L	107731
for two AS-Interface cables: LL	107732



# Cable Grommets



Explore the versatility of Trelleborg Cable Grommets, designed with a variety of configurations to cater to specific IP ratings and applications. These adaptable grommets are ideal for guiding both low and medium voltage power cables, tubes, and hoses. Choose from options that align with cut-outs based on PG dimensions or millimeter dimensions.

Crafted from a range of polymers, Trelleborg Cable Grommets not only ensure RoHS compliance but also exhibit outstanding weather resistance. Moreover, our product line includes fire retardant and oil-resistant models, providing a comprehensive solution to meet diverse requirements.

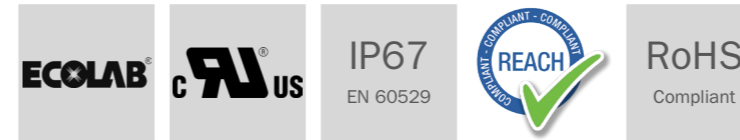

## Cable Grommets T-VET



### Dimensions

All dimensions to be used only as reference and not for quality control purposes

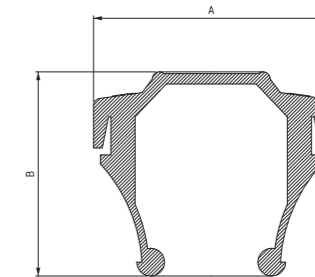

### Technical Specification

**Material:** thermoplastic elastomer

**Colour:** light grey and black

**Degree of protection:** IP67

**Flammability classification:** UL94 V-0

**Material service temperature (unstressed):** -40°C...+100°C

**Non-UL material versions available on request**

### Advantages

- Fast and easy assembly
- Double sealing with high IP protection
- Suitable for both indoor and outdoor use
- Fit PG cut-out dimensions

Art.No.	Description	Cable diameter	Cut-out	Cut-out Ø	A	B	Plate thickness	Box size
100746	T-VET 3-5 LIGHT GREY UL94 V-0	3mm - 5mm	PG7	Ø13mm	20	20	1mm - 4mm	1800
100747	T-VET 3-5 BLACK UL94 V-0	3mm - 5mm	PG7	Ø13mm	20	20	1mm - 4mm	1800
100749	T-VET 5-7 LIGHT GREY UL94 V-0	5mm - 7mm	PG9	Ø16mm	20	22	1mm - 4mm	1500
100187	T-VET 5-7 BLACK UL94 V-0	5mm - 7mm	PG9	Ø16mm	20	22	1mm - 4mm	1500
100751	T-VET 7-10 LIGHT GREY UL94 V-0	7mm - 10mm	PG11	Ø19mm	24	24	1mm - 4mm	1200
100188	T-VET 7-10 BLACK UL94 V-0	7mm - 10mm	PG11	Ø19mm	24	24	1mm - 4mm	1200
100190	T-VET 10-14 LIGHT GREY UL94 V-0	10mm - 14mm	PG16	Ø23mm	30	27	1mm - 4mm	700
100191	T-VET 10-14 BLACK UL94 V-0	10mm - 14mm	PG16	Ø23mm	30	27	1mm - 4mm	700
100192	T-VET 14-20 LIGHT GREY UL94 V-0	14mm - 20mm	PG21	Ø29mm	34	29	1mm - 4mm	400
100193	T-VET 14-20 BLACK UL94 V-0	14mm - 20mm	PG21	Ø29mm	34	29	1mm - 4mm	400
100755	T-VET 20-26 LIGHT GREY UL94 V-0	20mm - 26mm	PG29	Ø38mm	46	34	1mm - 4mm	250
100195	T-VET 20-26 BLACK UL94 V-0	20mm - 26mm	PG29	Ø38mm	46	34	1mm - 4mm	250
100197	T-VET 26-35 LIGHT GREY UL94 V-0	26mm - 35mm	PG37	Ø48mm	58	40	1mm - 4mm	120
100198	T-VET 26-35 BLACK UL94 V-0	26mm - 35mm	PG38	Ø48mm	58	40	1mm - 4mm	120



## Cable Grommets T-GET



### Dimensions

All dimensions to be used only as reference and not for quality control purposes

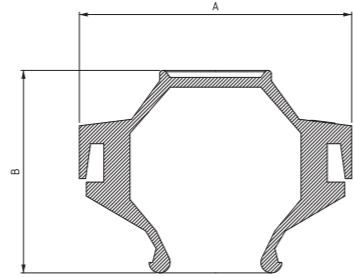

### Technical Specification

**Material:** thermoplastic elastomer  
**Colour:** light grey and black  
**Degree of protection:** IP67  
**Flammability classification:** UL94 V-0  
**Material service temperature (unstressed):** -40°C...+100°C  
**Non-UL material versions available on request**

### Advantages

- Fast and easy assembly
- Double sealing with high IP protection
- Suitable for both indoor and outdoor use
- Fit PG cut-out dimensions in mm

Art.No.	Description	Cable diameter	Cut-out	Cut-out Ø	A	B	Plate thickness	Box size
100723	T-GET 3-5 LIGHT GREY UL 94 V-0	3mm - 5mm	M12	Ø12.5mm	19	21	1mm - 5mm	1500
100724	T-GET 3-5 BLACK UL94 V-0	3mm - 5mm	M12	Ø12.5mm	19	21	1mm - 5mm	1500
100726	T-GET 5-7 LIGHT GREY UL94 V-0	5mm - 7mm	M16	Ø16.5mm	23	22	1mm - 5mm	1500
100727	T-GET 5-7 BLACK UL94 V-0	5mm - 7mm	M16	Ø16.5mm	23	22	1mm - 5mm	1500
100729	T-GET 7-10 LIGHT GREY UL94 V-0	7mm - 10mm	M20	Ø20.5mm	27	25	1mm - 5mm	1000
100730	T-GET 7-10 BLACK UL94 V-0	7mm - 10mm	M20	Ø20.5mm	27	25	1mm - 5mm	1000
100732	T-GET 10-14 LIGHT GREY UL94 V-0	10mm - 14mm	M25	Ø25.5mm	32	25	1mm - 5mm	600
100733	T-GET 10-14 BLACK UL94 V-0	10mm - 14mm	M25	Ø25.5mm	32	25	1mm - 5mm	600
100735	T-GET 14-20 LIGHT GREY UL94 V-0	14mm - 20mm	M32	Ø32.5mm	39	29	1mm - 5mm	400
100736	T-GET 14-20 BLACK UL94 V-0	14mm - 20mm	M32	Ø32.5mm	39	29	1mm - 5mm	400
100183	T-GET 20-26 LIGHT GREY UL94 V-0	20mm - 26mm	M40	Ø40.5mm	46	33	1mm - 5mm	250
100184	T-GET 20-26 BLACK UL94 V-0	20mm - 26mm	M40	Ø40.5mm	46	33	1mm - 5mm	250
100739	T-GET 26-35 LIGHT GREY UL94 V-0	26mm - 35mm	M50	Ø50.5mm	57	40	1mm - 5mm	140
100740	T-GET 26-35 BLACK UL94 V-0	26mm - 35mm	M50	Ø50.5mm	57	40	1mm - 5mm	140
100741	T-GET 30-45 LIGHT GREY UL94 V-0	30mm - 45mm	M63	Ø63.5mm	69	61	1mm - 5mm	175
100185	T-GET 30-45 BLACK UL94 V-0	30mm - 45mm	M63	Ø63.5mm	69	61	1mm - 5mm	175
100742	T-GET 40-60 GREY UL94 V-0	40mm - 60mm	M75	Ø76mm	89	79	1.2mm - 5.2mm	80
100743	T-GET 40-60 BLACK UL94 V-0	40mm - 60mm	M75	Ø76mm	89	79	1.2mm - 5.2mm	80



## Cable Grommets VET



### Dimensions

All dimensions to be used only as reference and not for quality control purposes

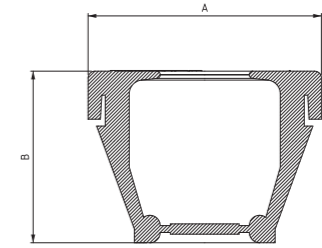

### Technical Specification

**Material:** EPDM rubber  
**Material properties:** halogen-free  
**Colour:** grey and black  
**Degree of protection:** IP67  
**Material service temperature (unstressed):** -40°C...+120°C  
**Other materials (VMQ,CR) available on request**

### Advantages

- Fast and easy assembly
- Double sealing with high IP protection
- Suitable for both indoor and outdoor use
- Fit PG cut-out dimensions

Art.No.	Description	Cable diameter	Cut-out	Cut-out Ø	A	B	Plate thickness	Box size
100715B	VET 3-5 BLACK EPDM	3mm - 5mm	PG7	Ø13mm	20	13	1mm - 4mm	1000
100716B	VET 3-5 GREY EPDM	3mm - 5mm	PG7	Ø13mm	20	13	1mm - 4mm	1000
100306B	VET 5-7 BLACK EPDM	5mm - 7mm	PG9	Ø16mm	20	20	1mm - 4mm	1000
100307B	VET 5-7 GREY EPDM	5mm - 7mm	PG9	Ø16mm	20	20	1mm - 4mm	1000
100291B	VET 8-14 BLACK EPDM	8mm - 14mm	PG16	Ø19mm	28	24	1mm - 4mm	1000
100292B	VET 8-14 GREY EPDM	8mm - 14mm	PG16	Ø19mm	28	24	1mm - 4mm	1000
100295B	VET 7-10 BLACK EPDM	7mm - 10mm	PG11	Ø23mm	24	21	1mm - 4mm	1000
100296B	VET 7-10 GREY EPDM	7mm - 10mm	PG11	Ø23mm	24	21	1mm - 4mm	1000
100297B	VET 14-20 BLACK EPDM	14mm - 20mm	PG21	Ø29mm	34	26	1mm - 4mm	500
100298B	VET 14-20 GREY EPDM	14mm - 20mm	PG21	Ø29mm	34	26	1mm - 4mm	500
100300B	VET 20-26 BLACK EPDM	20mm - 26mm	PG29	Ø38mm	46	30	1mm - 4mm	500
100301B	VET 20-26 GREY EPDM	20mm - 26mm	PG29	Ø38mm	46	30	1mm - 4mm	500
100304B	VET 26-35 BLACK EPDM	26mm - 35mm	PG36	Ø48mm	48	30	1mm - 4mm	200
100305B	VET 26-35 GREY EPDM	26mm - 35mm	PG36	Ø48mm	48	30	1mm - 4mm	200





## Cable Grommets GET



### Dimensions

All dimensions to be used only as reference and not for quality control purposes

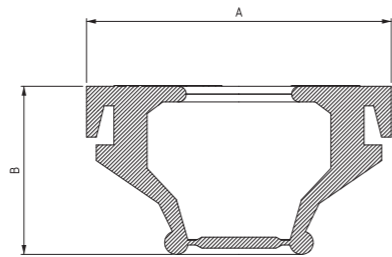

### Advantages

- Fast and easy assembly
- Double sealing with high IP protection
- Suitable for both indoor and outdoor use
- Fit PG cut-out dimensions in mm

### Technical Specification

**Material:** EPDM rubber  
**Material properties:** halogen-free  
**Colour:** grey and black  
**Degree of protection:** IP67  
**Material service temperature (unstressed):** -40°C...+120°C  
**Other materials (VMQ,CR) available on request**

Art.No.	Description	Cable diameter	Cut-out	Cut-out Ø	A	B	Plate thickness	Box size
100589B	GET 3-5 BLACK EPDM	3mm - 5mm	M12	Ø12.5mm	19	19	1,3 - 5mm	1000
100590B	GET 3-5 GREY EPDM	3mm - 5mm	M12	Ø12.5mm	19	19	1,3 - 5mm	1000
100587B	GET 5-7 BLACK EPDM	5mm - 7mm	M16	Ø16.5mm	23	19	1,3 - 5mm	1000
100231B	GET 5-7 GREY EPDM	5mm - 7mm	M16	Ø16.5mm	23	19	1,3 - 5mm	1000
100578B	GET 7-10 BLACK EPDM	7mm - 10mm	M20	Ø20.5mm	27	20	1,3 - 5mm	1000
100226B	GET 7-10 GREY EPDM	7mm - 10mm	M20	Ø20.5mm	27	20	1,3 - 5mm	1000
100574B	GET 10-14 BLACK EPDM	10mm - 14mm	M25	Ø25.5mm	32	20	1,3 - 5mm	1 000
100167B	GET 10-14 GREY EPDM	10mm - 14mm	M25	Ø25.5mm	32	20	1,3 - 5mm	1 000
100227B	GET 14-20 BLACK EPDM	14mm - 20mm	M32	Ø32.5mm	39	22	1,3 - 5mm	500
100228B	GET 14-20 GREY EPDM	14mm - 20mm	M32	Ø32.5mm	39	22	1,3 - 5mm	500
100583B	GET 20-26 BLACK EPDM	20mm - 26mm	M40	Ø40.5mm	47	24	1,3 - 5mm	500
100584B	GET 20-26 GREY EPDM	20mm - 26mm	M40	Ø40.5mm	47	24	1,3 - 5mm	500
100229B	GET 26-35 BLACK EPDM	26mm - 35mm	M50	Ø50.5mm	58	30	1,3 - 5mm	200
100230B	GET 26-35 GREY EPDM	26mm - 35mm	M50	Ø50.5mm	58	30	1,3 - 5mm	200
100223B	GET 30-45 BLACK EPDM	30mm - 45mm	M63	Ø63.5mm	69	45	1,3 - 5mm	100
100224B	GET 30-45 GREY EPDM	30mm - 45mm	M63	Ø63.5mm	69	45	1,3 - 5mm	100
100573B	GET40-60 BLACK EPDM	40mm - 60mm	M75	Ø76mm	90	60	1,3 - 5mm	50
100225B	GET 40-60 GREY EPDM	40mm - 60mm	M75	Ø76mm	90	60	1,3 - 5mm	50



## Cable Grommets T-GD



### Dimensions

All dimensions to be used only as reference and not for quality control purposes

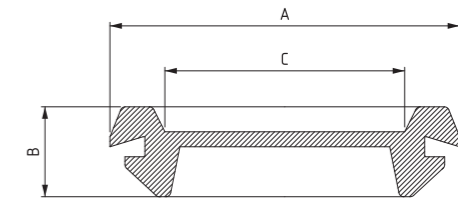

### Advantages

- Fast and easy assembly
- Suitable for both indoor and outdoor use
- Fit PG cut-out dimensions
- Can be used as a plug

### Technical Specification

**Material:** thermoplastic elastomer  
**Colour:** black  
**Flammability classification:** UL94 V-0  
**Degree of protection:** IP54 (IP65 if used as a plug)  
**Material service temperature (unstressed):** -40°C...+100°C  
**Non-UL material versions available on request**

Art.No.	Description	Cut-out	Cut-out Ø	A	B	C	Plate thickness	Box size
100174	T-GD 9 PG BLACK	PG9	Ø13mm	20	7	9	1mm - 2mm	3000
100175	T-GD 11 PG BLACK	PG11	Ø16mm	23	7	11	1mm - 2mm	3000
100176	T-GD 13,5 PG BLACK	PG13,5	Ø19mm	25	7	13,5	1mm - 2mm	2500
100177N	T-GD 16 PG BLACK	PG16	Ø23mm	28	7	16	1mm - 2mm	2500
100178	T-GD 21 PG BLACK	PG21	Ø29mm	35	9	21	1mm - 2mm	1000
100179	T-GD 29 PG BLACK	PG29	Ø38mm	44	10	29	1mm - 2mm	500
100180	T-GD 36 PG BLACK	PG36	Ø48mm	54	12	36	1.5mm - 3mm	200
100181	T-GD 48 PG BLACK	PG48	Ø60mm	68	12	48	1.5mm - 3mm	200
100182	T-GD 53 PG BLACK	PG53	Ø64mm	75	12	53	1.5mm - 3mm	200
100721	T-GD 69 PG BLACK	PG69	Ø80mm	90	12	69	1.5mm - 3mm	100



## Cable Grommets T-GDM



### Dimensions

All dimensions to be used only as reference and not for quality control purposes

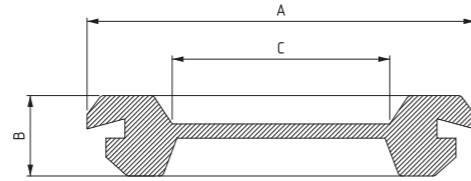

### Advantages

- Fast and easy assembly
- Suitable for both indoor and outdoor use
- Fit PG cut-out dimensions in mm
- Can be used as a plug

### Technical Specification

**Material:** thermoplastic elastomer  
**Colour:** black  
**Flammability classification:** UL94 V-0  
**Degree of protection:** IP54 (IP65 if used as a plug)  
**Material service temperature (unstressed):** -40°C...+100°C  
**Non-UL material versions available on request**

Art.No.	Description	Cut-out	Cut-out Ø	A	B	C	Plate thickness	Box size
103665	T-GDM 9 MM BLACK	M12	Ø12.5mm	17	7	9	1mm - 2mm	3000
103933N	T-GDM 11 MM BLACK	M16	Ø16.5mm	21	7	11	1mm - 2mm	3000
100176	T-GDM 13,5 MM BLACK	M20	Ø20.5mm	25	7	13,5	1mm - 2mm	2500
100200	T-GDM 16 MM BLACK	M25	Ø25.5mm	32	7	16	1mm - 2mm	2500
102342N	T-GDM 21 MM BLACK	M32	Ø32.5mm	40	9	21	1mm - 2mm	1000
103523N	T-GDM 29 MM BLACK	M40	Ø40.5mm	48	10	29	1mm - 2mm	500
104019N	T-GDM 36 MM BLACK	M50	Ø50.5mm	58	12	36	1.5mm - 3mm	200
100181	T-GDM 48 MM BLACK	M63	Ø63.5mm	68	12	48	1.5mm - 3mm	200
104022N	T-GDM 53 MM BLACK	M75	Ø76mm	81	12	53	1.5mm - 3mm	100
104023N	T-GDM 69 MM BLACK	M90	Ø91mm	91	12	69	1.5mm - 3mm	100



## Cable Grommets T-RGDM



### Dimensions

All dimensions to be used only as reference and not for quality control purposes

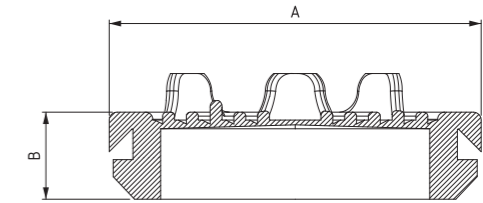

### Advantages

- Fast and easy assembly
- Sealing rings can easily be pulled off without extra tools
- Suitable for both indoor and outdoor use
- Fit M40, M50 or M60 cut-out

### Technical Specification

**Material:** thermoplastic elastomer  
**Colour:** grey and black  
**Flammability classification:** UL94 V-0 halogen-free  
**Degree of protection:** IP65  
**Material service temperature (unstressed):** -40 °C...+90 °C

Art.No.	Description	1 Cable diameter	Cut-out	Cut-out Ø	A	B	Plate thickness	Box size
107166	T-RGDM 40 BLACK UL94 V-0	10mm - 34mm	M40	Ø40.5mm	47	11	1 - 3.5 mm	400
108421	T-RGDM 40 LIGHT GREY UL94 V-0	10mm - 34mm	M40	Ø40.5mm	47	11	1 - 3.5 mm	400
106995	T-RGDM 50 BLACK UL94 V-0	12mm - 44mm	M50	Ø50.5mm	57	11	1 - 3.5 mm	250
108422	T-RGDM 50 LIGHT GREY UL94 V-0	12mm - 44mm	M50	Ø50.5mm	57	11	1 - 3.5 mm	250
107167	T-RGDM 60 BLACK UL94 V-0	12mm - 54mm	M60	Ø60.5mm	67	11	1 - 3.5 mm	200
108423	T-RGDM 60 LIGHT GREY UL94 V-0	12mm - 54mm	M60	Ø60.5mm	67	11	1 - 3.5 mm	200



IP54  
EN 60529



RoHS  
Compliant

## Cable Grommets M 20-80



### Dimensions

All dimensions to be used only as reference and not for quality control purposes

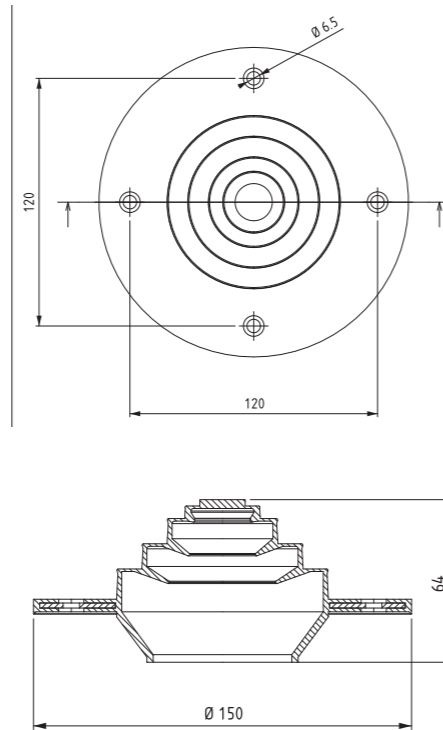

### Advantages

- Suitable for cable diameters up to 80mm
- Suitable for both indoor and outdoor use

### Technical Specification

**Material:** thermoplastic elastomer

**Colour:** grey and black

**Flammability classification:** UL94 V-0

**Degree of protection:** IP54

**Material service temperature (unstressed):**

-40 °C...+100 °C

**Non-UL material versions available on request**

Art.No.	Description	Box size	Packing
104049	M 20-80 LIGHT GREY UL94 V-0	50	Bulk
101035	M 20-80 BLACK UL94 V-0	50	Bulk

# Product Configurator

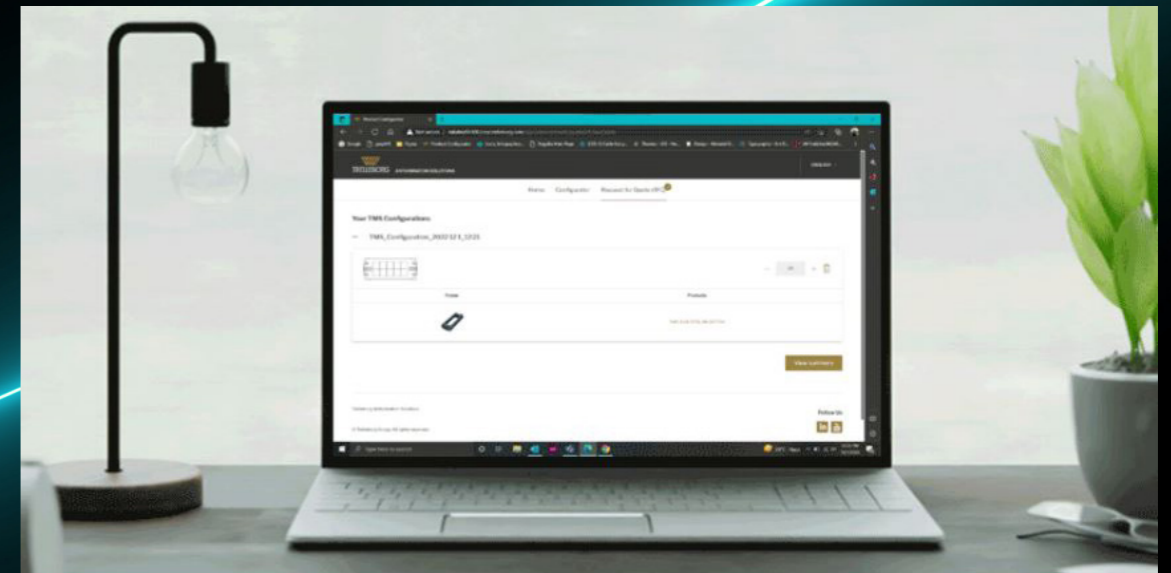

### CABLE ENTRY SOLUTIONS PRODUCT SELECTION MADE EASY WITH OUR SMART CONFIGURATOR.

With over 1,000 potential configurations it is the solution that offers maximum flexibility in electrical design, installation and service. You can create your own system depending on your requirements for number of cables and diameters, replace grommets later on if needed and use pre-assembled cables with connectors.



Create your own configuration  
Scan QR code





Trelleborg Antivibration Solutions (AVS) - Leading the Frontier of Innovation in Noise and Vibration Control. With our advanced polymer technology and expertise in rubber-to-metal bonding, we're pioneers in combating noise and vibration. As part of Trelleborg Group's Industrial Solutions, we bring over a century of excellence to various sectors like rail, marine, and industrial. Our focus is on crafting isolation, attenuation, and suspension solutions that redefine quality and reliability. Our new value proposition, "The Frontline of Innovation," signifies our commitment to pushing polymer technology's limits. We enhance comfort, safety, and efficiency while extending product life and optimizing costs. Join us at Trelleborg AVS for innovation-driven excellence.



Website



Linked In



**TRELLEBORG INDUSTRIAL  
PRODUCTS FINLAND OY**  
KIKKERLÄNTIE 72  
38300 SASTAMALA  
FINLAND



**TRELLEBORG INDUSTRIAL AVS  
INDIA PVT LTD**  
RAJDHANI INDUSTRIAL PARK,  
PLOT 285, KIADB AVVERHALLI  
INDUSTRIAL AREA  
562 2111 BANGALORE  
INDIA



**TRELLEBORG  
INDUSTRIAL AVS**  
NO. 8, ZHONGTONG ROAD  
WUXI, JIANGSU  
214143  
CHINA