

Pneumatic Fenders

**EXPERT MANUFACTURING, LIFETIME DURABILITY
FULLY ISO17357-1:2014 COMPLIANT**

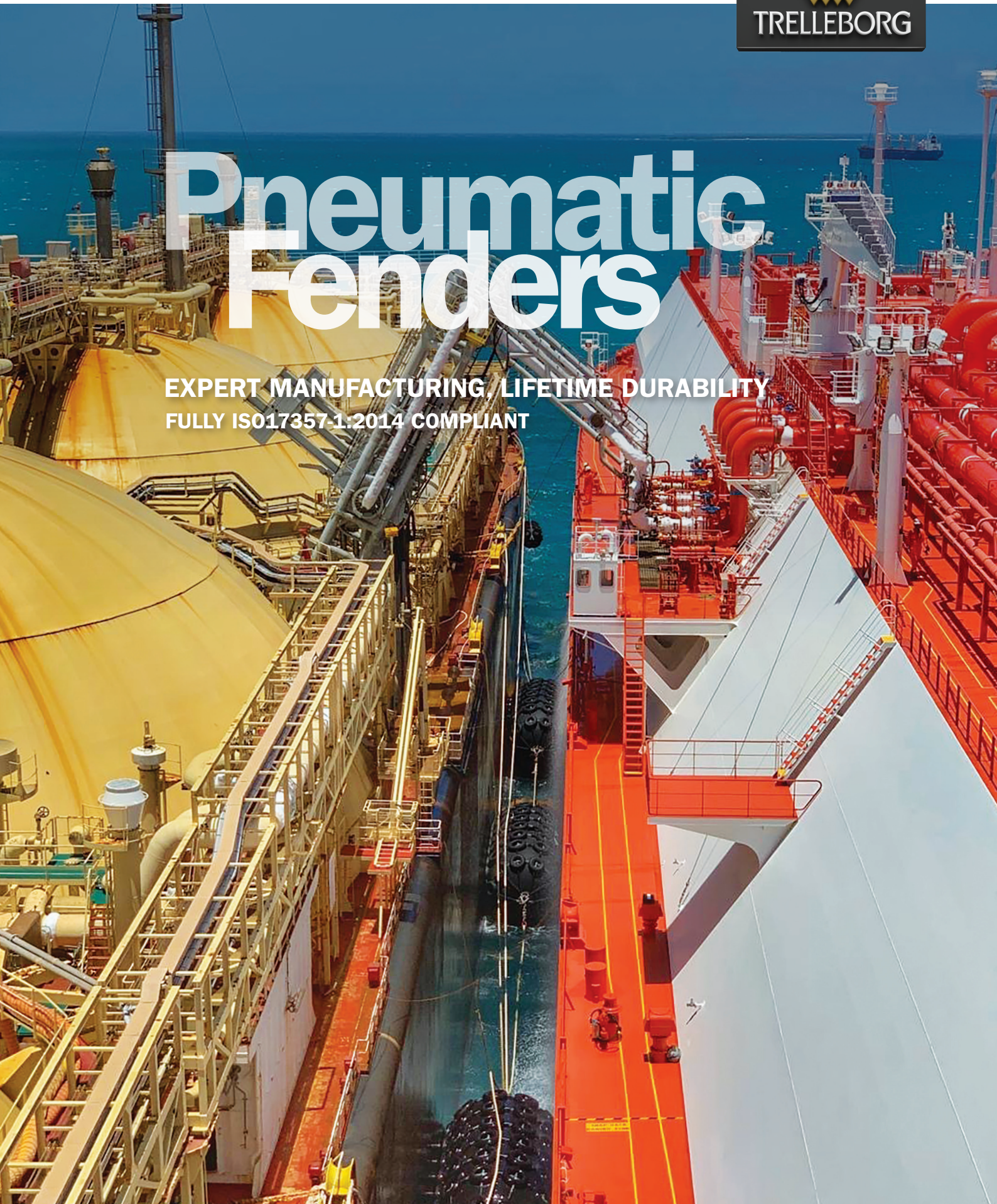

The Smarter Approach

Better connected systems mean faster turnaround and increased throughput, improved safety and lower operating costs.

Connecting decades of experience with a new, smarter approach to port and terminal equipment optimization, Trelleborg Marine and Infrastructure helps ports and terminals deploy smart, engineered solutions for port approach, berthing, and docking and mooring. This enables better informed, real-time and strategic decision-making, both onshore and on board the vessel.

From port owners and operators to consulting engineers, Trelleborg works with customers to determine best-fit solutions for specific applications, and supply a fully-integrated solution. Our end-to-end service and comprehensive product portfolio meets and exceeds customer needs, enhancing safety and efficiency in all marine environments, from conception to completion and beyond.

Contents

Pneumatic Fenders

Introduction	5
Types of Fenders	6
Better by Design	7
Construction	8
Product Characteristics	10
Test and Inspection Requirements	12
End Fittings	14
Installation Dimensions	16
Hydro Pneumatic Fenders	17
Lightweight Pneumatic Fenders	18
Pneumatic SmartFenders	20
Maintenance	21

A Smarter Approach at every stage

A smarter approach to...

CONSULTATION

Consultation from the earliest project phase to ensure the optimum fender systems and marine technology solutions are specified, with full technical support from our global offices.



CONCEPT

Conceptual design in your local office – with full knowledge of local standards and regulations, delivered in your language – for optimized port and vessel solutions.



DESIGN

Concepts are taken to our Engineering Centers of Excellence in India where our team generates 3D CAD designs, application-engineering drawings, a bill of materials, finite engineering analyses and calculations for both our fender systems and marine technology solutions.



MANUFACTURE

Our entire product range is manufactured in-house, meaning we have full control over the design and quality of everything we produce. Our strategically located, state-of-the-art facilities ensure our global, industry leading manufacturing capability.



TESTING

Across our entire product range, stringent testing comes as standard at every step in our in-house manufacturing process. We ensure that lifecycle and performance of our entire product range meets your specifications, and more.



INSTALLATION

Dedicated project management, from solution design right the way through to on-site installation support. We design products and solutions that always consider ease of installation and future maintenance requirements.



SUPPORT

Local support on a truly global scale, with customer support teams all over the world. And this service doesn't stop after a product is installed. You have our full support throughout the entire lifetime of your project, including customized training programs, maintenance and onsite service and support.



THE FUTURE

Deploying the latest in smart technologies to enable fully automated, data-driven decision making that optimizes port and terminal efficiency. At Trelleborg, we're constantly evolving to provide the digital infrastructure our industry increasingly needs.



When you choose Trelleborg you ensure your expectations will be met, because we deliver a truly end-to-end service – retaining vigilance and full control at every stage.

Introduction

With over 100 years of industry-leading expertise in engineered polymer solutions that seal, damp and protect critical applications in demanding environments, Trelleborg Marine and Infrastructure is one of the most trusted and reliable suppliers of high-quality marine solutions for all industries.

Trelleborg combines global engineering support to ensure customers receive excellent care and support before, during and after sales, as well as a local service to provide pneumatic fenders for specialized projects all over the world.

Fully-integrated manufacturing capabilities bring together a range of qualities to ensure a long, low-maintenance service life, no matter how demanding the working and environmental conditions. This end-to-end service includes research and development, expert fender design, high-quality materials, manufacturing, testing and stringent quality control.

All of Trelleborg's pneumatic fenders are supplied fully compliant to ISO 17357-1:2014 standards and consist of unique and high-performance characteristics which originate from Trelleborg's attention to detail during the manufacturing process. These characteristics combine low reaction force and low hull pressure with excellent berthing capabilities, which remain consistent throughout varying angular compressions. The fenders also incorporate a rugged construction to deliver improved durability and performance that reduces operational downtime and increases service life.

Trelleborg's fender systems can be integrated with SmartPort, a technology platform that connects data-driven assets, to give stakeholders a holistic view of operations and improve communication and decision-making.

Take a Smarter Approach to pneumatic fenders with Trelleborg and benefit from a lifetime of durable performance.

All of our pneumatic fenders are supplied fully compliant to ISO 17357-1:2014 standards.



Types of Fenders

The most common types of pneumatic fenders that are compliant with the international standard ISO 17357-1:2014 are CTN (TYPE I & TYPE I Single) and sling fenders (TYPE II).

Both fender types are typically suspended using chains or guy ropes, secured with shackles to an anchor or mooring point.

Choosing the right type of fender depends on its application, usage and the requirements of the facility.

CTN FENDERS (TYPE I)

Chain-tire net (CTN) fenders (TYPE I) are easy and fast to deploy, maintaining large clearances between the vessel hull and the structure. The fenders consist of a lattice of used tires connected by a network of horizontal and vertical chains, which adds further protection to the fender body. The chains are galvanized for greater corrosion resistance and covered by rubber sleeves to prevent abrasive damage to the fender body and vessel hull. The chains are fastened with hammerlocks at each intersection, and connected to the towing lug with shackles.

Each TYPE I fender is supplied with a specifically designed CTN with a U2-grade chain as standard, as well as a varying diameter size, routing and a number of tires (aircraft or truck tires) that are specifically designed to provide optimal coverage and durability during the most extreme operational conditions for each fender size.

SLING FENDERS (TYPE II)

Trelleborg's Sling fenders are expertly manufactured to ISO 17357 standards in a purpose-built mold. The fenders can be slung by chains or wire ropes during operation. These fenders are available across the entire range of sizes.



TYPE I & TYPE I Single Standard Protection Fender showing the CTN



TYPE I & TYPE I Single High Protection Fender showing the extra rolls of shoulder tires



Type II Sling Fender with lifting eye at both ends

Better by Design

DESIGNED TO ISO 17357-1:2014 STANDARDS

Trelleborg's pneumatic fenders are designed, manufactured and third-party certified in compliance with ISO 17357-1:2014.

ISO 17357-1:2014 details three major elements of construction and their physical properties:

- The outer rubber
- The tire-cord reinforcing layer
- The inner rubber

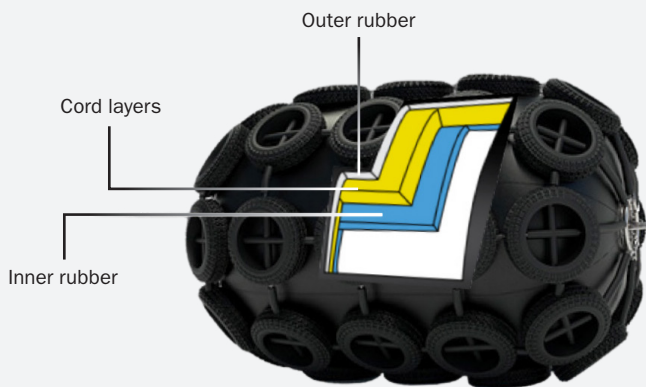

These layers are vulcanized at a high pressure in a mold and hardened at a high temperature, which ensures superior bonding between layers of dissimilar characteristics.

OUTER RUBBER

The tough abrasion-resistant outer rubber is designed to protect the inner rubber and tire-cord layers from damaging external forces. The material has mechanical properties to withstand the arduous operational conditions for which the fenders are designed.

TIRE-CORD LAYER

Carefully selected synthetic tire-cord layers have proven to be the best option for strong, efficient reinforcement for Trelleborg's pneumatic fenders. Each layer is coated with a rubber compound on both sides that prevents contact between the layers, reducing friction and wear during bending, compression and stretching. The same compound isolates each thread within the layer. This greatly enhances the ability of the fender to hold pressure as well as improve fatigue resistance and extend endurance life. It is crucial that tire-cord layers are arranged at an optimum angle, in order to ensure the distribution of load is even and to ensure pneumatic fenders remain shape conformant.

INNER RUBBER

The inner rubber's primary function is to conceal pressurized air inside the fender body at 50kPa or 80 kPa. The inner rubber of Trelleborg's pneumatic fenders is constructed from specifically designed compounds and special curing process to ensure optimum air-tightness of up to six times the industry standards. This ensures working pressure is retained inside the fender allowing the fender to perform with a consistent guaranteed energy absorption and reaction force against the vessel hull.

Construction

The production of the outer and inner rubber is conducted in accordance with the specification given in the table below as specified by ISO 17357-1:2014.

OUTER AND INNER RUBBER MATERIAL PROPERTIES REQUIREMENTS

TEST ITEM	TEST METHOD	REQUIRED VALUE	
		OUTER RUBBER	INNER RUBBER
Before ageing		Original	Original
Tensile strength	BS ISO 37	18 Mpa or more	10 Mpa or more
Elongation	BS ISO 37	400% or more	400% or more
Hardness	ISO 48	60 +/- 10 (durometer hardness test type A)	50 +/- 10 (durometer hardness test type A)
After ageing	ISO 188	Air oven ageing. 70°C +/- 1°C. 96 h	Air oven ageing. 70°C +/- 1°C. 96 h
Tensile strength	BS ISO 37	Not less than 80% of the original property	Not less than 80% of the original property
Elongation	BS ISO 37	Not less than 80% of the original property	Not less than 80% of the original property
Hardness	ISO 48	Not to exceed the original property by more than 8	Not to exceed the original property by more than 8
Tear	BS ISO 34-1	400 N/cm or more	No requirement
Compression set	ISO 815	30% (70°C +/-1°C for 22h) or less	No requirement
Static ozone resistance	ISO 1431-1	No cracks after elongation by 20% and exposure to 50 ppm at 40°C for 96 h	No requirement



Construction

STANDARD SIZES

Regardless of type or pressure, fenders are measured by diameter and length, generally expressed in millimeters (mm).

DIAMETER × LENGTH (mm × mm)	INNER PRESSURE (kPa)	AVERAGE BODY WEIGHT (kg)	CTN WEIGHT (TTSP) (kg)	CTN WEIGHT (ATSP) (kg)	CTN WEIGHT (TTHP) (kg)	CTN WEIGHT (ATHP) (kg)
500 × 1000	50	32				
	80	32				
1000 × 1500	50	87	167	215		
	80	122				
1000 × 2000	50	112	176	224		
	80	128				
1200 × 2000	50	117	216	276		
	80	147				
1350 × 2500	50	197	322	412		
	80	232				
1500 × 3000	50	292	374	416	555	688
	80	352				
1700 × 3000	50	338	399	507	514	682
	80	338				
2000 × 3500	50	488	570	651	781	893
	80	558				
2500 × 4000	50	768	964	1097	1094	1254
	80	898				
2500 × 5500	50	1068	1168	1266	1693	1885
	80	1238				
3300 × 4500	50	1133	1440	1496-1744	1910	1928-2486
	80	1353				
3300 × 6500	50	1483	2331	2306-3050	2862	2790-3906
	80	1848				
3300 × 10600	50	2488	3910	3766-5254	5051	4799-7031
	80	2848				
4500 × 9000	50	3494	4367	4237-5787	5430	5214-7446
	80	4004				
4500 × 12000	50	4444	5989	5709-8189	7173	6777-10125
	80	5044				

Body weights may vary slightly dependent on fender Type I, Type I Single or II, and/or within ISO 17357-1:2014 standards.

Approx. theoretical calculated weight of CTN. So, weight may vary as per availability of actual tire model.

Product Characteristics

PERFORMANCE DATA

DIAMETER × LENGTH (mm × mm)	50 kPa			80 kPa		
	PERFORMANCE DATA			PERFORMANCE DATA		
	GEA (kNm)	RF AT GEA (kN)	HULL PRESSURE AT GEA (kN/m ²)	GEA (kNm)	RF AT GEA (kN)	HULL PRESSURE AT GEA (kN/m ²)
500 × 1000	6	64	132	8	85	174
1000 × 1500	32	182	122	45	239	160
1000 × 2000	45	257	132	63	338	174
1200 × 2000	63	297	126	88	390	166
1350 × 2500	102	427	130	142	561	170
1500 × 3000	153	579	132	214	761	174
1700 × 3000	191	639	128	267	840	168
2000 × 3500	308	875	128	430	1150	168
2500 × 4000	663	1381	137	925	1815	180
2500 × 5500	943	2019	148	1317	2653	195
3300 × 4500	1175	1884	130	1640	2476	171
3300 × 6500	1814	3015	146	2532	3961	191
3300 × 10600	3067	5257	158	4281	6907	208
4500 × 9000	4752	5747	146	6633	7551	192
4500 × 12000	6473	7984	154	9037	10490	202

NON-STANDARD SIZES

Some applications may require sizes outside of those specified in ISO standards. Trelleborg can customize fenders to meet your specifications, additional sizes can be manufactured upon request

SIZE (OD X L) (mm)	SIZE (OD X L) (mm)
300 x 500	1700 x 7200
300 x 600	2000 x 3000
500 x 800	2000 x 6000
700 x 1500	3000 x 5000
1200 x 1800	4500 x 6400
1500 x 2500	4500 x 7000

PERFORMANCE CURVE

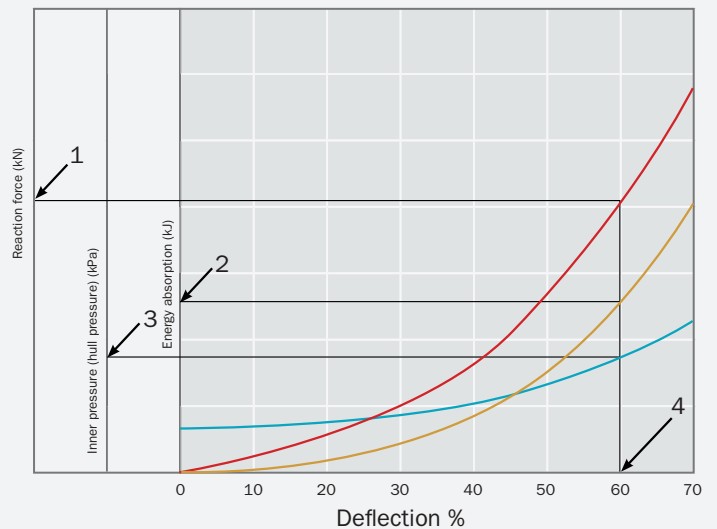

- Reaction force
 - Energy absorption
 - Inner pressure
1. Reaction force at GEA deflection
 2. Guarantee energy absorption (GEA)
 3. Hull pressure at GEA deflection
 4. GEA deflection

Product Characteristics

PRESSURE RATINGS

Trelleborg Marine and Infrastructure manufactures fenders with two initial pressures: 50 kPa (Pneumatic 50) and 80 kPa (Pneumatic 80). Design values are given below:

PNEUMATIC 50 SIZE (OD X L) (mm)	INTERNAL PRESSURE (kPa)		MINIMUM ENDURABLE PRESSURE (kPa)		SAFETY-VALVE PRESSURE SETTING (kPa)	TESTING PRESSURE AT 0 % DEFLECTION (kPa)
	AT 0 % DEFLECTION	AT 60 % DEFLECTION	AT 0 % DEFLECTION	AT 60 % DEFLECTION		
500 × 1000	50	132	300	462	–	200
1000 × 1500	50	122	300	427	–	200
1000 × 2000	50	132	300	462	–	200
1200 × 2000	50	126	300	441	–	200
1350 × 2500	50	130	300	455	–	200
1500 × 3000	50	132	300	462	–	200
1700 × 3000	50	128	300	448	–	200
2000 × 3500	50	128	300	448	–	200
2500 × 4000	50	137	350	480	175	250
2500 × 5500	50	148	350	518	175	250
3300 × 4500	50	130	350	455	175	250
3300 × 6500	50	146	350	511	175	250
3300 × 10600	50	158	350	553	175	250
4500 × 9000	50	146	350	511	175	250
4500 × 12000	50	154	350	539	175	250

PNEUMATIC 80 SIZE (OD X L) (mm)	INTERNAL PRESSURE (kPa)		MINIMUM ENDURABLE PRESSURE (kPa)		SAFETY-VALVE PRESSURE SETTING (kPa)	TESTING PRESSURE AT 0 % DEFLECTION (kPa)
	AT 0 % DEFLECTION	AT 60 % DEFLECTION	AT 0 % DEFLECTION	AT 60 % DEFLECTION		
500 × 1000	80	174	480	609	–	250
1000 × 1500	80	160	480	560	–	250
1000 × 2000	80	174	480	609	–	250
1200 × 2000	80	166	480	581	–	250
1350 × 2500	80	170	480	595	–	250
1500 × 3000	80	174	480	609	–	250
1700 × 3000	80	168	480	588	–	250
2000 × 3500	80	168	480	588	–	250
2500 × 4000	80	180	560	630	230	300
2500 × 5500	80	195	560	683	230	300
3300 × 4500	80	171	560	599	230	300
3300 × 6500	80	191	560	669	230	300
3300 × 10600	80	208	560	728	230	300
4500 × 9000	80	192	560	672	230	300
4500 × 12000	80	202	560	707	230	300

Test And Inspection Requirements

Acceptance testing and inspection for Trelleborg fenders are based on the tests and inspections indicated in the following table:

TEST AND INSPECTION REQUIREMENTS FOR COMMERCIAL FENDERS AS PER ISO 17357-1:2014

TEST	STANDARD	DESCRIPTION	REMARKS
Confirmation from material certificate that tire cord is used	ISO 17357-1:2014	Synthetic-tire-cord layers have been proven to provide strong efficient reinforcement layers in fenders. Each single layer is coated with rubber compound on both sides as well as in between synthetic-tire-cord threads, hence isolating all cords from each other.	If alternative reinforcement methods to tire cord are used, test certificates proving that strength and durability are designed and proven to be equal or superior to the tire cord after exhaustive trials, shall be evaluated and certified by a major classification society as well as a material certificate used for the ordered fenders.
Material testing		Physical properties of inner and outer rubber.	Tensile / elongation / hardness before aging shall be conducted once every lot. The rest of the tests should be conducted once a year.
Dimensional inspection		Length: +10%, -5% Diameter: +10%, -5% The diameters of bead ring or other steel material around the flange opening shall be less than 0.20 x fender diameter.	Dimensional inspection to be carried out at initial internal pressure (working pressure).
Air leakage		The air leakage test shall be conducted at initial internal pressure for more than 30 minutes	All fenders to be tested for each and every order.
Hydrostatic test		Test shall be preformed for 10 minutes at the hydrostatic pressure shown as "Testing pressure at 0 % deflection" in "Pressure Rating" table. Maximum circumferential and longitudinal temporary elongation: 10%	The frequency of test shall be one in 20 fenders for each size and pressure.
Confirmation of marking		Each fender shall have markings to indicate the following: <ul style="list-style-type: none"> ■ International standard applicable year ■ Size ■ Initial internal pressure ■ Date of manufacture ■ Name of manufacturer ■ Individual serial number ■ Type of reinforcement layer 	The identification system shall be designed to last throughout the fender's life.

SAFETY VALVE

Pneumatic fenders of 2,500 mm diameter and larger are fitted with an adequately designed safety valve. This is to efficiently release excess pressure in order to match the pressure stipulated by ISO 17357-1:2014 during accidental berthing. An efficiently designed safety valve protects the long-term integrity of the fender asset, therefore increasing the safety of vessels and port infrastructure.

TOWING LUG

Towing lug rating per fender size. Values are third-party verified by SGS.

ITEM	SUITABLE FENDER SIZE	REQUIRED TEST LOAD	ACTUAL TEST LOAD
1	1000 to 1200	17 tons /166.6KN	18.45 tons /180.8KN
2	1350 to 2000	34 tons /333.2KN	34.3 tons /336.16KN
3	2500 to 3300	50 tons /490KN	50.06 tons /490.56KN
4	33106 to 4500	110 tons /1078KN	112.54 tons /1102.88KN

SAFETY VALVE DIAGRAM

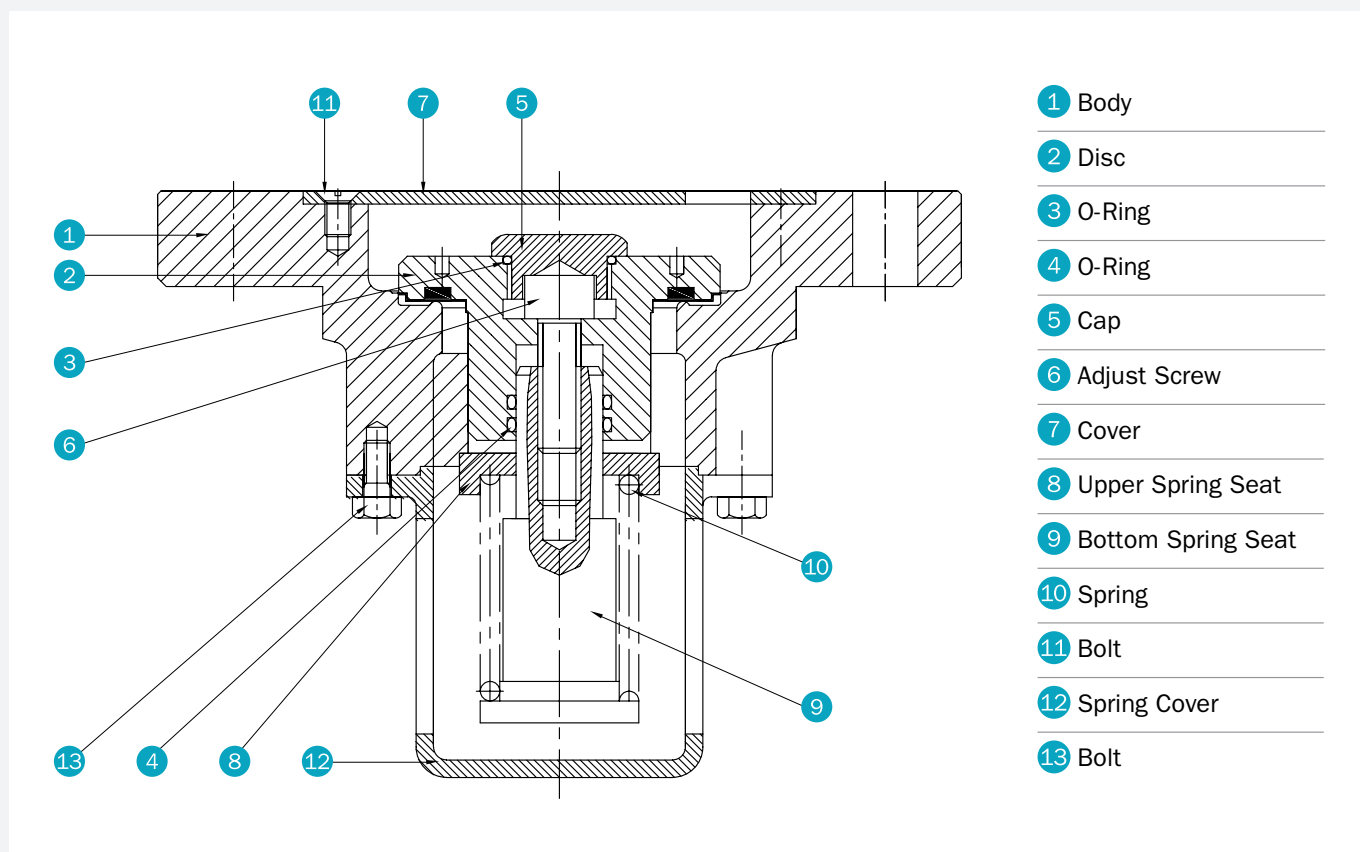

End Fittings

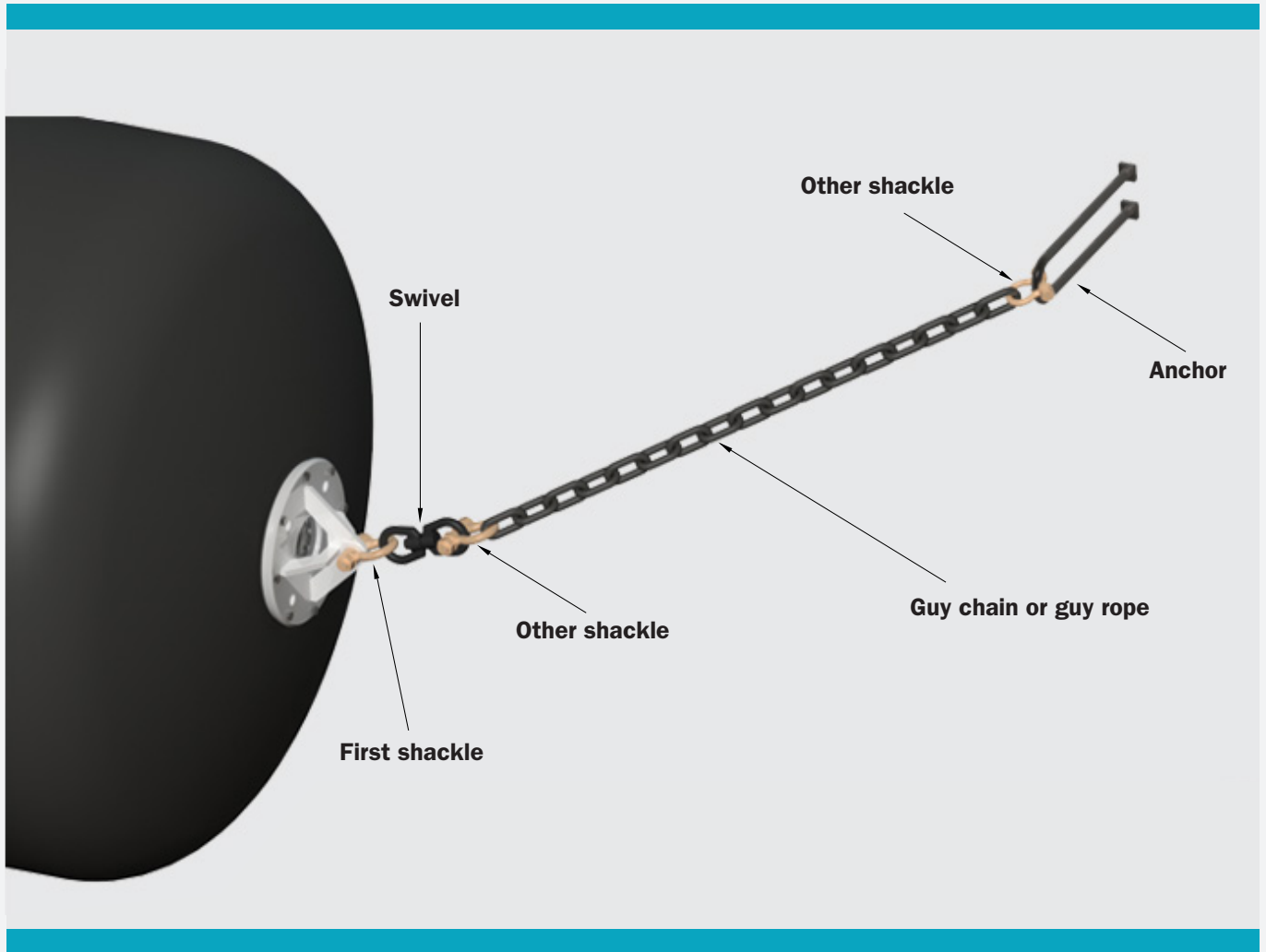

FENDER FIXING ACCESSORIES (50 kPa Initial Pressure)

DIAMETER × LENGTH	FIRST SHACKLE DIAMETER	SWIVEL DIAMETER	OTHER SHACKLE DIAMETER	GUY CHAIN DIAMETER	GUY ROPE (6 X 24) DIAMETER	U ANCHOR DIAMETER
mm x mm	mm (Inch)	mm (Inch)	mm (Inch)	mm (Inch)	mm (Inch)	mm (Inch)
500 × 1000	19 (3/4)	NA	19 (3/4)	16 (5/8)	16 (5/8)	25 (1)
1000 × 1500	22 (7/8)	19 (3/4)	22 (7/8)	16 (5/8)	16 (5/8)	25 (1)
1000 × 2000	22 (7/8)	19 (3/4)	22 (7/8)	16 (5/8)	16 (5/8)	25 (1)
1200 × 2000	25 (1)	22 (7/8)	25 (1)	19 (3/4)	18 (11/16)	25 (1)
1350 × 2500	25 (1)	22 (7/8)	25 (1)	19 (3/4)	22 (7/8)	25 (1)
1500 × 3000	25 (1)	25 (1)	25 (1)	22 (7/8)	22 (7/8)	25 (1)
1700 × 3000	25 (1)	25 (1)	25 (1)	22 (7/8)	22 (7/8)	30 (1-3/16)
2000 × 3500	25 (1)	32 (1-1/4)	25 (1)	22 (7/8)	24 (15/16)	30 (1-3/16)
2500 × 4000	32 (1-1/4)	38 (1-1/2)	32 (1-1/4)	30 (1-3/16)	30 (1-3/16)	36 (1-7/16)
2500 × 5500	38 (1-1/2)	38 (1-1/2)	38 (1-1/2)	34 (1-5/16)	36 (1-7/16)	42 (1-5/8)
3300 × 4500	38 (1-1/2)	38 (1-1/2)	38 (1-1/2)	34 (1-5/16)	36 (1-7/16)	42 (1-5/8)
3300 × 6500	45 (1-3/4)	44 (1-3/4)	45 (1-3/4)	42 (1-5/8)	42 (1-5/8)	52 (2-1/16)
3300 × 10600	65 (2-1/2)	58 (2-5/16)	65 (2-1/2)	58 (2-5/16)	58 (2-5/16)	70 (2-3/4)
4500 × 9000	65 (2-1/2)	58 (2-5/16)	65 (2-1/2)	58 (2-5/16)	58 (2-5/16)	75 (3)
4500 × 12000	75 (3)	68 (2-11/16)	75 (3)	68 (2-11/16)	68 (2-11/16)	85 (3-3/8)

FENDER FIXING ACCESSORIES (80 kPa Initial Pressure)

DIAMETER × LENGTH	FIRST SHACKLE DIAMETER	SWIVEL DIAMETER	OTHER SHACKLE DIAMETER	GUY CHAIN DIAMETER	GUY ROPE (6 X 24) DIAMETER	U ANCHOR DIAMETER
mm x mm	mm (Inch)	mm (Inch)	mm (Inch)	mm (Inch)	mm (Inch)	mm (Inch)
500 × 1000	19 (3/4)	NA	19 (3/4)	19 (3/4)	18 (11/16)	25 (1)
1000 × 1500	22 (7/8)	19 (3/4)	22 (7/8)	19 (3/4)	18 (11/16)	25 (1)
1000 × 2000	22 (7/8)	19 (3/4)	22 (7/8)	19 (3/4)	18 (11/16)	25 (1)
1200 × 2000	25 (1)	22 (7/8)	25 (1)	22 (7/8)	22 (7/8)	25 (1)
1350 × 2500	25 (1)	22 (7/8)	25 (1)	22 (7/8)	22 (7/8)	25 (1)
1500 × 3000	25 (1)	25 (1)	25 (1)	26 (1-1/16)	26 (1-1/16)	30 (1-3/16)
1700 × 3000	25 (1)	25 (1)	25 (1)	26 (1-1/16)	26 (1-1/16)	30 (1-3/16)
2000 × 3500	25 (1)	32 (1-1/4)	25 (1)	30 (1-3/16)	30 (1-3/16)	36 (1-7/16)
2500 × 4000	32 (1-1/4)	38 (1-1/2)	32 (1-1/4)	34 (1-5/16)	36 (1-7/16)	42 (1-5/8)
2500 × 5500	38 (1-1/2)	38 (1-1/2)	38 (1-1/2)	42 (1-5/8)	44 (1-3/4)	52 (2-1/16)
3300 × 4500	38 (1-1/2)	38 (1-1/2)	38 (1-1/2)	42 (1-5/8)	44 (1-3/4)	52 (2-1/16)
3300 × 6500	45 (1-3/4)	44 (1-3/4)	45 (1-3/4)	50 (2)	52 (2-1/16)	62 (2-7/16)
3300 × 10600	65 (2-1/2)	58 (2-5/16)	65 (2-1/2)	66 (2-9/16)	68 (2-11/16)	80 (3-1/8)
4500 × 9000	65 (2-1/2)	58 (2-5/16)	65 (2-1/2)	70 (2-3/4)	70 (2-3/4)	85 (3-3/8)
4500 × 12000	75 (3)	68 (2-11/16)	75 (3)	84 (3-5/16)	80 (3-1/8)	100 (4)

All sizes are recommended for pneumatic fenders always floating with slack chains and not suspended, for other application and fixing arrangement contact Trelleborg Marine and Infrastructure.

Installation Dimensions

Pneumatic fenders must be installed on a solid structure or a reaction panel to ensure it is adequately supported during impacts.

CHAIN-TIRE NET FENDERS

FENDER SIZE		a	b	c	d	e	W
DIAMETER	LENGTH						
1000	1500	836	942	1342	335	506	1950
1000	2000	881	942	1342	290	461	2600
1200	2000	1105	1131	1611	300	505	2600
1350	2500	1251	1272	1812	330	561	3250
1500	3000	1457	1414	2014	300	557	3900
1700	3000	1641	1602	2282	350	641	3900
2000	3500	1982	1885	2685	360	702	4550
2500	4000	2498	2356	3356	430	858	5200
2500	5500	2538	2356	3356	390	818	7150
3300	4500	3335	3110	4430	530	1095	5850
3300	6500	3365	3110	4430	500	1065	8450
3300	10600	3395	3110	4430	470	1035	13780
4500	9000	4701	4241	6041	570	1341	11700
4500	12000	4721	4241	6041	550	1321	15600

Units: [mm]

SLING FENDERS

FENDER SIZE		a	b	c	d	e	W
DIAMETER	LENGTH						
500	1000	456	471	671	130	216	1300
1000	1500	1021	942	1342	150	321	1950
1000	2000	1031	942	1342	140	311	2600
1200	2000	1265	1131	1611	140	345	2600
1350	2500	1411	1272	1812	170	401	3250
1500	3000	1597	1414	2014	160	417	3900
1700	3000	1791	1602	2282	200	491	3900
2000	3500	2132	1885	2685	210	552	4550
2500	4000	2678	2356	3356	250	678	5200
2500	5500	2688	2356	3356	240	668	7150
3300	4500	3545	3110	4430	320	885	5850
3300	6500	3595	3110	4430	270	835	8450
3300	10600	3615	3110	4430	250	815	13780
4500	9000	4931	4241	6041	340	1111	11700
4500	12000	4961	4241	6041	310	1081	15600

Units: [mm]

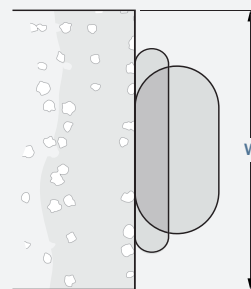
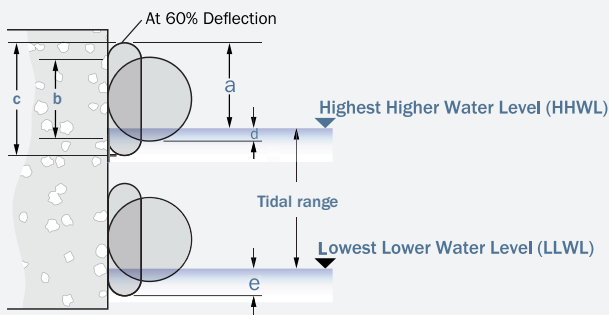

Please contact Trelleborg Marine & Infrastructure for installation of other sizes and other CTN protection

Hydro Pneumatic Fenders

Hydro pneumatic fenders (HPNE) fenders are primarily used for berthing submarines and vessels that have low free board and high draft, which may result in fender contact below the waterline.

Upon installation, a HPNE fender is typically required to be partially water-filled, then pressurized with air and ballasted to stand vertically. Fender performance can be adjusted to suit the application requirements by altering the water to air ratio and inflation pressure.

IMPROVED DESIGN

Trelleborg's HPNE fenders are designed and manufactured to be stronger and more durable than standard pneumatic fenders due to added pressure requirements. The fender is inflated with water and equipped with a counterweight to ensure the fender stays at the designed draft line, allowing it to operate efficiently in submerged conditions. The volume of the water within the fender is closely related to the reaction force, guaranteed energy absorption and minimum endurable pressure.



**DOWNLOAD
HPNE FENDER
BROCHURE**



Benefits of HPNE fenders

- Unique, specially-adapted design
- Sub-surface contact face
- Very low hull pressures
- Variable draft
- Prevent acoustic tile damage

Applications

- Submarines
- Fast ferries (selected)
- Semi-submersible oil rigs

Lightweight Pneumatic Fenders

Trelleborg is now offering a lightweight CTN construction for TYPE I & TYPE I Single Pneumatic fenders of 3300 and 4500 diameters.

The lightweight CTN option significantly reduces fender weight without impacting fender performance, making the fenders easier to mobilize, while helping to overcome any loading/unloading issues operators may face with larger diameter fenders.

Additional information:

- ISO 17357-1:2014 body with re-designed CTN for weight reduction
- In place of tires we have proposed carefully selected rubber hose pipes – each with a diameter of OD 200
- The steel chain has been replaced with a synthetic chain – the synthetic chain strength of 200 kN remains consistent to the steel chain used on standard CTN, but the weight is significantly reduced to 0.65kg/m
- Bow shackle, D-shackle, and the towing lug remain unchanged
- GEA, reaction forces, and product performance remain unchanged

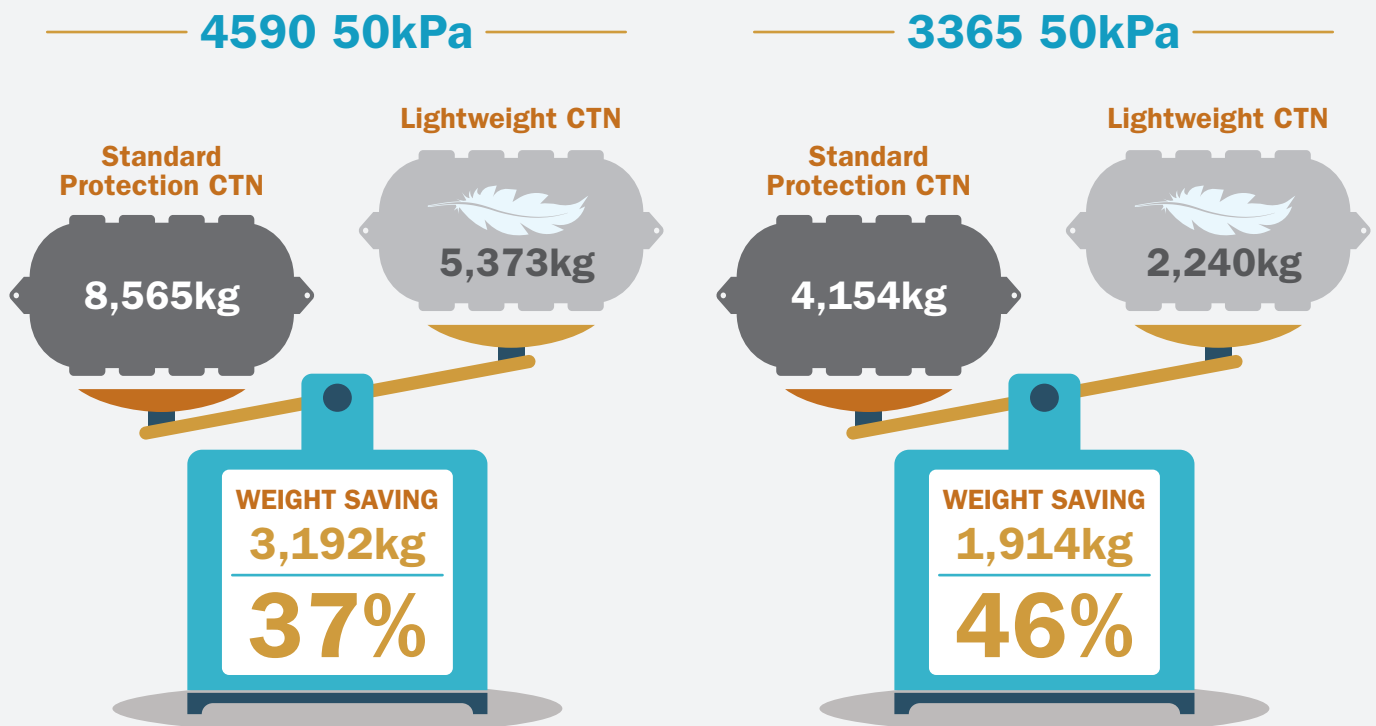

These ranges are average values. For more information please contact Trelleborg Marine and Infrastructure.

PNE Ø 3.3 X 6.5 L LIGHT WEIGHT FENDER SYSTEM

PART NO.	DESCRIPTION	QTY/ SYSTEM	SIZE		WEIGHT	TOTAL WEIGHT
1R	Rubber Sleeve	140 mtr	OD 150 x ID 130		4.3kg/mtr	602
2B	Tow Shackle	48 Nos.	16 mm		1.15 kg/unit	55.2
3D	Shackle	24 Nos.	7/8" (G-210)		1.62 kg/unit	38.88
4T	Towing Lug	2 Nos.	PNE2500-PNE3300		38 kg/unit	76
5S	Synthetic Chain	140 mtr	Inner Dim (100mm L x 25mm W)	Cross Section (25mm W x 15mm T)	0.65 kg/mtr	91
6B	Tow Shackle	4 Nos.	1 -3/4" (G-2130)		14.29 kg/unit	57.16
7S	Swivel	2 Nos.	44 mm, GR U3		20.5 kg/unit	41
					Total Approx. Weight	961.24

LIGHTWEIGHT FENDER COMPARISON

Internal Pressure: 50 kPa

DIAMETER x LENGTH (mm x mm)	STANDARD CTN (ATSP) FENDER WEIGHT (kg)	LIGHT WEIGHT FENDER WEIGHT (kg)	WEIGHT SAVING (kg)
3300 x 6500	4154	2240	1914
3300 x 10600	6907	3909	2998
4500 x 7000	6854	4557	2297
4500 x 9000	8565	5373	3192
4500 x 12000	11358	6694	4664

Internal Pressure: 80 kPa

DIAMETER x LENGTH (mm x mm)	STANDARD CTN (ATSP) FENDER WEIGHT (kg)	LIGHT WEIGHT FENDER WEIGHT (kg)	WEIGHT SAVING (kg)
3300 x 6500	4519	2605	1914
3300 x 10600	7267	4269	2998
4500 x 7000	7364	5067	2297
4500 x 9000	9075	5883	3192
4500 x 12000	11958	7294	4664

Pneumatic SmartFenders

Powered By
SmartPort®



Trelleborg's pneumatic SmartFenders continuously monitor fender location and performance, providing valuable insights that can help extend asset life, prevent downtime and optimize maintenance schedules.

The connected fender monitors internal pressure, temperature and geographical location, ensuring asset operability in even the most remote locations. Generated data is wirelessly sent to Trelleborg's SmartPort cloud, where it is processed and stored. Using the SmartPort user interface accessed on a smartphone or tablet, users will be made aware of unnatural fender behavior and will receive an instant fender status update.

Trelleborg's pneumatic SmartFenders are powered by SmartPort technology and can be integrated with other products in the SmartPort portfolio. The assets are connected through the SmartPort cloud, providing a complete overview of the port and vessel interface in one common user interface.

Benefits of using Pneumatic SmartFenders

Pneumatic SmartFenders help improve the operational efficiency of offshore mooring and transfer operations by:

- Ensuring asset operability, avoiding downtime linked to misplacement or insufficient pressure
- Assessing fender status, facilitating preventative maintenance to extend asset life
- Augmenting situational awareness in remote offshore operations
- Providing insight into fender occupancy, infrastructure utilization and future investment needs
- Digitizing and simplifying asset records, enabling easy access to, and analysis of, all material

**LEARN MORE
ABOUT SMARTPORT**



Maintenance

REDUCED MAINTENANCE

Our mission is to ensure an industry-leading product lifespan for our pneumatic fenders. A unique combination of engineering and design expertise, higher-grade materials and manufacturing process produces a pneumatic fender that is proven to perform better over the long term, even in demanding marine environment. This reduces the need for significant repair and simplifies maintenance requirements.

All fenders require some upkeep. At Trelleborg we have designed our fenders to minimize the time needed for routine maintenance, which means less disruption to our customers' operations and more efficient throughput and transfer activities.

Our manufacturing methods ensure that we take the necessary steps in order to overcome common failures in pneumatic fenders such as delamination, air leakage, volumetric expansion, elongation and premature failure.

Inspection

Trelleborg's fenders are designed to last. It is advisable to carry out regular inspection of the fender's condition in line with our Handling, Storage, Inspection and Maintenance instructions. Any minor cuts and abrasions on the fenders surface can be treated early, to prolong the lifespan of the fender.

Repair

A fender repair kit is provided with each Trelleborg fender, which includes materials and instruments for minor repairs. However, for fenders requiring major repairs, please contact your local Trelleborg office for assistance.

After-sales

Trelleborg Marine and Infrastructure offers an after-sales service, providing maintenance, repairs and training to assist you with your needs.



DISCLAIMER

Trelleborg AB has made every effort to ensure that the technical specifications and product descriptions in this brochure are correct.

The responsibility or liability for errors and omissions cannot be accepted for any reason whatsoever. Customers are advised to request a detailed specification and certified drawing prior to construction and manufacture. In the interests of improving the quality and performance of our products and systems, we reserve the right to make specification changes without prior notice. All dimensions, material properties and performance values quoted are subject to normal production and testing tolerances. This brochure supersedes the information provided in all previous editions. If in doubt, please check with Trelleborg Marine and Infrastructure.

© Trelleborg AB, PO Box 153, 231 22 Trelleborg, Sweden.

This brochure is the copyright of Trelleborg AB and may not be reproduced, copied or distributed to third parties without the prior consent of Trelleborg AB in each case.





**For a smarter approach
to your next project,
get in touch today.**

Email: marine_infra@trelleborg.com



Trelleborg is a world leader in engineered polymer solutions that seal, damp and protect critical applications in demanding environments. Its innovative solutions accelerate performance for customers in a sustainable way.

WWW.TRELLEBORG.COM/MARINEANDINFRASTRUCTURE



facebook: [TrelleborgMarineandInfrastructure](https://www.facebook.com/TrelleborgMarineandInfrastructure)
twitter: [@TrelleborgMI](https://twitter.com/TrelleborgMI)
[youtube.com/c/TrelleborgMarineInfrastructure](https://www.youtube.com/c/TrelleborgMarineInfrastructure)
[flickr.com/people/marineandinfrastructure](https://www.flickr.com/people/marineandinfrastructure)
[linkedin.com/company/trelleborg-marine-and-infrastructure](https://www.linkedin.com/company/trelleborg-marine-and-infrastructure)
TheSmarterApproachBlog.trelleborg.com