



# User manual

## Vega Flat high-pressure lifting bags

# 1.0. TABLE OF CONTENTS

---

|  |           |
|--|-----------|
| <b>2.0. LIST OF ATTACHMENTS</b>                                  | <b>3</b>  |
| <b>3.0. GENERAL INFORMATION ON THE PRODUCT FAMILY</b>            | <b>3</b>  |
| 3.1. BASIC FUNCTIONS AND FIELD OF APPLICATION                    | 3         |
| 3.2. IMPORTANCE OF INSTRUCTIONS                                  | 3         |
| 3.3. CONFORMITY TO STANDARDS                                     | 4         |
| 3.4. MANUFACTURER  | 4         |
| <b>4.0. DEFINITIONS</b>  | <b>5</b>  |
| <b>5.0. SAFETY INFORMATION FOR THE USER</b>                      | <b>6</b>  |
| 5.1. SAFETY INSTRUCTIONS BEFORE USE                              | 6         |
| 5.2. PERSONAL PROTECTIVE EQUIPMENT                               | 6         |
| 5.3. ENVIRONMENTAL CONDITIONS AND RESTRICTIONS                   | 6         |
| 5.4. CARRYING SAVA LIFTING BAGS                                  | 7         |
| 5.5. TRANSPORT AND STORAGE                                       | 7         |
| 5.6. STORAGE AND PROTECTION OF THE PRODUCT WHEN NOT IN OPERATION | 8         |
| 5.7. SAFETY INSTRUCTIONS BEFORE USE                              | 8         |
| 5.8. CHOOSING THE RIGHT SAVA LIFTING BAG                         | 8         |
| <b>6.0. PRODUCT IDENTIFICATION</b>                               | <b>9</b>  |
| 6.1. TYPE OF PRODUCT   | 9         |
| 6.2. LIFETIME  | 10        |
| <b>7.0. OPERATING INSTRUCTIONS</b>                               | <b>11</b> |
| 7.1. DESCRIPTION OF LIFTING BAGS                                 | 11        |
| 7.2. PREPARING THE LIFTING BAG FOR LIFTING                       | 14        |
| 7.3. DISCONNECTING THE LIFTING BAGS                              | 16        |
| 7.4. LIFTING METHODS   | 18        |
| <b>8.0. UNEXPECTED SITUATIONS</b>                                | <b>23</b> |
| <b>9.0 ACCESSORIES</b>   | <b>24</b> |
| <b>10.0. MAINTENANCE AND CLEANING</b>                            | <b>24</b> |
| 10.1. MAINTENANCE AND CLEANING OF SAVA LIFTING BAGS AFTER USE    | 25        |
| 10.2. MAINTENANCE OF INFLATION AND CONNECTING HOSES AFTER USE    | 25        |
| 10.3. MAINTENANCE OF CONTROLLERS AFTER USE                       | 26        |
| <b>11.0. PREVENTIVE MAINTENANCE</b>                              | <b>26</b> |
| 11.1. INSPECTION INTERVALS                                       | 27        |
| 11.2. TEST PROCEDURES  | 28        |
| <b>12.0. FAULT IDENTIFICATION AND TROUBLESHOOTING</b>            | <b>31</b> |

## 2.0. LIST OF ATTACHMENTS

---

- ATTACHMENT 1: Warranty Terms and Conditions
- ATTACHMENT 2: Quick start guide
- ATTACHMENT 3: Media resistance table
- ATTACHMENT 4: Technical data
- ATTACHMENT 5: List of accessories

## 3.0. GENERAL INFORMATION ON THE PRODUCT FAMILY

---

### 3.1. BASIC FUNCTIONS AND FIELD OF APPLICATION

SAVA flat lifting bags are designed for lifting, lowering, positioning, separating and moving loads of up to 100.3 t (110.3 US t), mainly in rescue operations; however, industrial applications are also possible.

### 3.2. IMPORTANCE OF INSTRUCTIONS



Please read the User Manual carefully before using the product. Keep the manual for future reference. The User Manual must be made available to all users of high-pressure flat lifting bags.

The long version of the user manual is available on the website at:

<https://www.trelleborg.com/en/seals-and-profiles/products-and-solutions/rescue-products-and-haz-mat/manuals>

Each product has the manufacturer's test report attached. In addition to the test report, a Quick Start Guide for working with lifting bags is included.



The Quick Start Guide for working with lifting bags is included with each product. It is also provided at the end of the User Manual. We suggest that you laminate the page and attach it to the lifting bag to make it available to users at all times.

#### 3.2.1. INTERPRETATION OF PICTOGRAMS

The pictograms used in the user manual are explained in the table below. Other markings in the user manual are unambiguous and comprehensible.

Table 1: Explanation of the pictograms.

| PICTOGRAM | MEANING            | EXPLANATION   |
|-----------|--------------------|---|
|           | <b>HAZARD</b>      | A signal word indicating a potential high-risk hazard which, if not avoided, could result in death or serious injury.   |
|           | <b>WARNING</b>     | A signal word indicating a potential medium-risk hazard which, if not avoided, could result in death or serious injury. |
|           | <b>CAUTION</b>     | A signal word indicating a potential low-risk hazard which, if not avoided, could cause minor or moderate injury.       |
|           | <b>INFORMATION</b> | A signal word indicating a risk of material damage and/or damage to property. There is no risk for injuries.            |

### 3.2.2. MEANING OF IMAGES IN THE USER MANUAL

All images, drawings and photos in this User Manual are for information and illustration purpose only.

### 3.3. CONFORMITY TO STANDARDS

SAVA high-pressure lifting bags of the **VEGA Flat** type meet the requirements of EN13731:2007.

### 3.4. MANUFACTURER



# TRELLEBORG

**TRELLEBORG SLOVENIJA, d.o.o.**

PG Environmental Protection & Rescue Products

Škofjeloška cesta 6  
4000 Kranj, Slovenia

T: + 386 4 206 63 88  
F: + 386 4 206 63 90

E: [tis.kra.info.eko@trelleborg.com](mailto:tis.kra.info.eko@trelleborg.com)

W: [www.trelleborgslovenija.com](http://www.trelleborgslovenija.com)

## 4.0. DEFINITIONS

---

The meaning of words and phrases in the user manual is explained in the table below.

Table 2: Definitions

| <b>WORD / PHRASE</b>                                 | <b>MEANING</b>  |
|--|---|
| <b>CONVENTIONAL LIFTING BAG</b>                      | A high-pressure lifting bag that changes the shape and size of the load-bearing surface during filling with air or water.   |
| <b>FLAT LIFTING BAG/FLAT BAG</b>                     | A high-pressure lifting bag whose design allows an almost uniform raising across its entire surface during filling with air or other media while also maintaining the shape and size of the load-bearing surface. |
| <b>CONTACT SURFACE</b>                               | The entire top or bottom surface of the bag.  |
| <b>LOAD-BEARING SURFACE</b>                          | The surface of the lifting bag in contact with the load or object to be lifted during the lifting phase, which determines the lifting capacity of the bag.  |
| <b>CONTROLLER</b>                                    | A device for the supply, discharge and control of the filling medium in the lifting bags.   |
| <b>WORKING PRESSURE</b>                              | Pressure in the lifting bag during operation.   |
| <b>PERMISSIBLE PRESSURE</b>                          | Maximum inflation pressure in the lifting bag during operation specified by the manufacturer.   |
| <b>INFLATION CONNECTION</b>                          | A connection on the lifting bag for connecting the inflation hoses.   |
| <b>PRESSURE REGULATOR OR PRESSURE REDUCING VALVE</b> | A device which reduces the pressure of the filling medium to a prescribed maximum pressure.   |
| <b>SAFETY VALVE</b>                                  | A device that protects the entire system by relieving the excessive pressure from the system.   |
| <b>LIFTING CAPACITY</b>                              | Maximum weight of the load that can be lifted by the lifting bag at a given pressure.   |
| <b>CONNECTING HOSES</b>                              | Hoses for connecting the controller and the lifting bags.   |
| <b>INFLATION HOSE</b>                                | A hose between the air source and the controller.   |
| <b>VISUAL INSPECTION</b>                             | Visual inspection of a product that is not pressurised.   |
| <b>FUNCTIONAL TEST</b>                               | Inspection of a pressurised product.  |
| <b>PERIODIC TEST</b>                                 | A detailed periodic inspection by the manufacturer or a person authorised by the manufacturer.  |

## 5.0. SAFETY INFORMATION FOR THE USER

---

### 5.1. SAFETY INSTRUCTIONS BEFORE USE



Make sure that you carefully read the instructions before use.

Rescue teams should undertake training according to the internal regulations that apply to professional rescuers. For other users, training by the manufacturer or an authorised training provider is mandatory.

### 5.2. PERSONAL PROTECTIVE EQUIPMENT

Wear personal protective equipment when working with SAVA lifting bags. Firefighters and rescue team members should use the entire protective gear specified for their specific work. Other users should wear a safety helmet, safety goggles and gloves, and protective footwear.



### 5.3. ENVIRONMENTAL CONDITIONS AND RESTRICTIONS



Failure to follow the instructions may lead to risks to users and third parties and may result in various injuries; therefore, it is mandatory to read the instructions before use.

**WARNING: do not reach under a load that is not protected by mechanical safety supports.**



Do not exceed the maximum inflation pressure.

Do not stack more than three flat lifting bags on top of each other.

Do not inflate a flat lifting bag to more than 1 bar (14.5 psi) with no load on it.

Keep inflating the lifting bag until the required or maximum height and/or maximum working pressure is reached.



It is not permitted to use any SAVA lifting bag in a manner other than that provided for in this User Manual.

In case of unauthorised use, the manufacturer accepts no liability.



Use the specified personal protective equipment when working with lifting bags.

The use of lifting bags and accessories which have not passed the periodic tests within the test intervals indicated in section 6.3.1 is not permitted.



#### TEMPERATURE RANGE OF USE

The temperature range of use is  $-20$  to  $+80^{\circ}\text{C}$  ( $-4$  to  $+176^{\circ}\text{F}$ ). The use of the product at temperatures below  $-20^{\circ}\text{C}$  ( $-4^{\circ}\text{F}$ ) but not below  $-40^{\circ}\text{C}$  ( $-40^{\circ}\text{F}$ ) is limited to a maximum of 1 hour, and at temperatures above  $+80^{\circ}\text{C}$  ( $+176^{\circ}\text{F}$ ) to 30 minutes provided that the temperature does not exceed  $+100^{\circ}\text{C}$  ( $+212^{\circ}\text{F}$ ).



#### TEMPERATURE OF THE LIFTING OBJECT

If the surface temperature of the object to be lifted exceeds  $55^{\circ}\text{C}$  ( $131^{\circ}\text{F}$ ), the side of the SAVA lifting bag in contact with the object should be protected by plywood or a rubberised steel plate to protect the bag against heat damage. The minimum temperature to which SAVA lifting bags retain their lifting capacity and material properties is  $-20^{\circ}\text{C}$  ( $-4^{\circ}\text{F}$ ).



#### LIGHTING THE PLACE OF USE

Even if it is easy to position and inflate the SAVA lifting bag, working in the dark is dangerous. Make sure there is sufficient light so that the place of use is not in the darkness or shaded. We also recommend that you use additional lights during the day when visibility is significantly reduced due to shading. Do not use open flames for lighting in the dark.



#### PRESENCE OF AUTHORISED PERSONS

Only qualified persons are allowed to be present at preparations for load lifting/lowering. Other persons must keep away from the area of preparations and lifting/lowering procedure. Where people and the environment could be exposed to additional hazards, e.g., fire outbreak due to fuel leakage, other measures must also be taken by competent personnel to reduce the risk.



#### FIRE AREAS

Lifting bags may be used in fire areas only after the temperature of the bearing surface between the load and the bag, and the ground drops below  $55^{\circ}\text{C}$  ( $131^{\circ}\text{F}$ ).



The standard version of lifting bags **is NOT** suitable for use in potentially explosive atmospheres. Use dedicated lifting bags of a special design in potentially explosive atmospheres. Consult the manufacturer for more information.



Vega flat lifting bags are resistant to certain types of chemicals. Chemical resistance for rubber materials is indicated in the attached Media Resistance Table. Consult the manufacturer for resistance to the chemicals not listed in the attached Table.

## 5.4. CARRYING SAVA LIFTING BAGS

Carry the lifting bag upright. Make sure that the inflation connection is always at the top to prevent damage if the bag falls.

Larger and heavier lifting bags such as the VEGA Flat 40/17 and VEGA Flat 55/17 or several lifting bags together should be carried by two persons.

## 5.5. TRANSPORT AND STORAGE

Lifting bags are packed in cardboard packaging with special protection for their sensitive parts. They must be placed horizontally or vertically when transported. Twisting or folding of the product is prohibited.



Do not use sharp objects such as knives or screwdrivers, etc., to remove packaging, as they could damage the lifting bag.



The packaging is made of cardboard, which is fully recyclable, therefore it should never be permanently discarded. Dispose of it in containers designated for recycled paper or in special containers for cardboard packaging.

## 5.6. STORAGE AND PROTECTION OF THE PRODUCT WHEN NOT IN OPERATION

Store SAVA lifting bags in a dry and dark place.

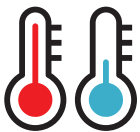

Storage temperature: from +5 °C (+41 °F) to +25 °C (+77 °F).

We recommend that you store lifting bags horizontally. Also make sure that the inflation connection is at the front and clearly visible to avoid any damage when moving the lifting bag.

If you store lifting bags upright, we recommend that you fix them to a base (wall) to prevent twisting. The inflation connection should face upwards.

We recommend that you store lifting bags in PVC bags to reduce various environmental impacts on the product during storage.

## 5.7. SAFETY INSTRUCTIONS BEFORE USE



Quick start guide and a manufacturer's test report are attached with each SAVA lifting bag.  
**Keep the User Manual and periodic test documents throughout the lifetime of the lifting bag.**

## 5.8. CHOOSING THE RIGHT SAVA LIFTING BAG

The following information helps you choose the right lifting bag:

- shape of the load,
- weight of the load to be lifted,
- required lifting height.

Based on the weight of the load to be lifted, the required lifting height, and the diagrams from Attachment 4, the right lifting bag can be chosen.

*Example:*

*We want to lift a load of 25 t (27.6 US t) to a height of 100 mm (4") using one lifting bag.*

*We can use a flat lifting bag VEGA Flat 20/17, VEGA Flat 40/17 or VEGA Flat 55/17. The VEGA Flat 10/17 lifting bag does not provide sufficient lifting capacity for a height of 100 mm.*



## 6.0. PRODUCT IDENTIFICATION

### 6.1. TYPE OF PRODUCT

- VEGA conventional lifting bag
- NOVA conventional lifting bag

#### 6.1.1. DESCRIPTION OF THE LIFTING BAG



Figure 6.1: Schematic description of SAVA lifting bag

#### 6.1.2. LABEL DATA

##### Main label:

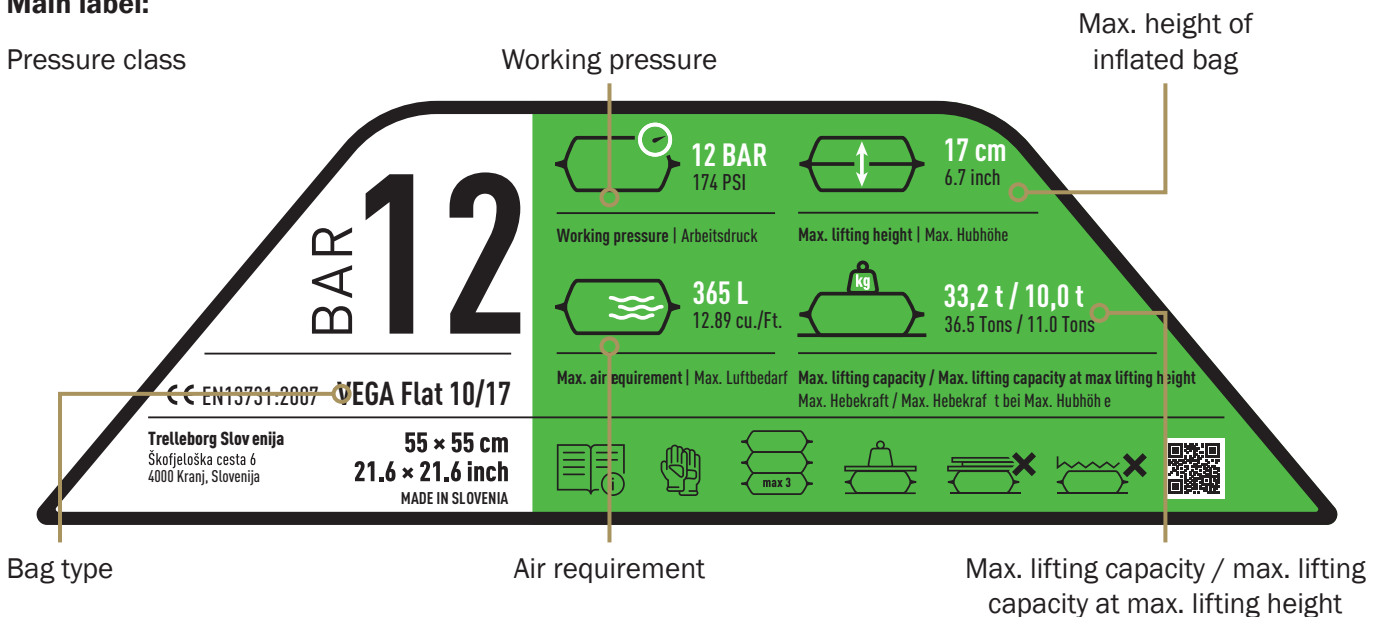

Figure 6.2: Explanation of bag label data

### Side label:

Pressure class

Max. lifting capacity  
at max. lifting height

**10 t (11.0 Tons) 17cm (6.7 inch)**

Max. lifting height

#### 6.1.3. MARKING OF LIFTING HEIGHT

The lifting height of VEGA flat high-pressure lifting bags is also presented graphically next to the main handle (if the bag is placed upright on the edge), see Figure 6.3.



Figure 6.3: Graphic illustration of lifting height on VEGA Flat high-pressure flat lifting bags.

#### 6.1.4. SERIAL NUMBER DATA

The serial number is located on the edge of the product handle next to the side label.

It consists of a number and a QR code. The first two digits in the number are the month of manufacture, the following two are the year of manufacture while the remaining digits are the serial number of the product manufactured. In the bottom line of the serial number, the uncoded data on time of manufacture is added, where m (month) stands for the month of manufacture and y (year) for the year of manufacture. The QR code is a graphic image of the serial number.

The example in Figure 6.4 shows a lifting bag manufactured in September (09), year 2020

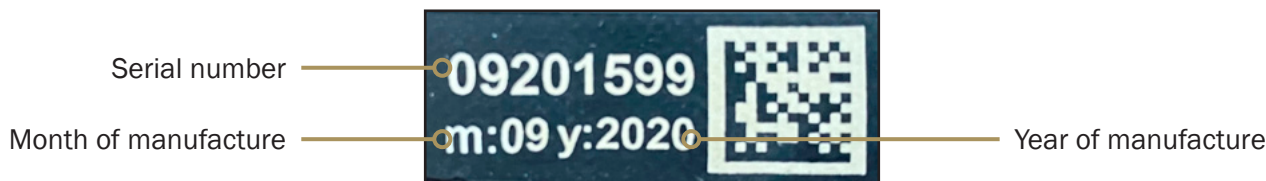

Figure 6.4: Serial number of a lifting bag.

## 6.2. LIFETIME

The expected lifetime of the product is 15 years provided it is properly used and maintained.



**Lifting bags are made of rubber and therefore subject to the natural ageing process. Although visual inspection shows that lifting bags are still in good condition, discard them after 15 years, as ageing phenomena, invisible to the naked eye, may be present in the structure of the material.**

Destructed or damaged products or products that have reached the end of their useful life must be taken out of service. They should never be thrown away as ordinary waste. Lifting bags are recyclable waste. Classification should be carried out in accordance with local regulations.



The product can be partially recycled.

## 7.0. OPERATING INSTRUCTIONS

### 7.1. DESCRIPTION OF LIFTING BAGS



Lifting bags can be inflated with air or water only.  
The use of other gases and liquids is not permitted.



Inflating lifting bags without using the controllers with built-in safety valves is not permitted.  
Do not stack more than three flat lifting bags on top of each other.



Do not inflate the lifting bag to more than 1 bar (14.5 psi) with no load on it.  
Inflate the lifting bag until the required or maximum lifting height and/or maximum working pressure is reached.

To lift a load with SAVA lifting bags, have ready (see Figure 7.1.):

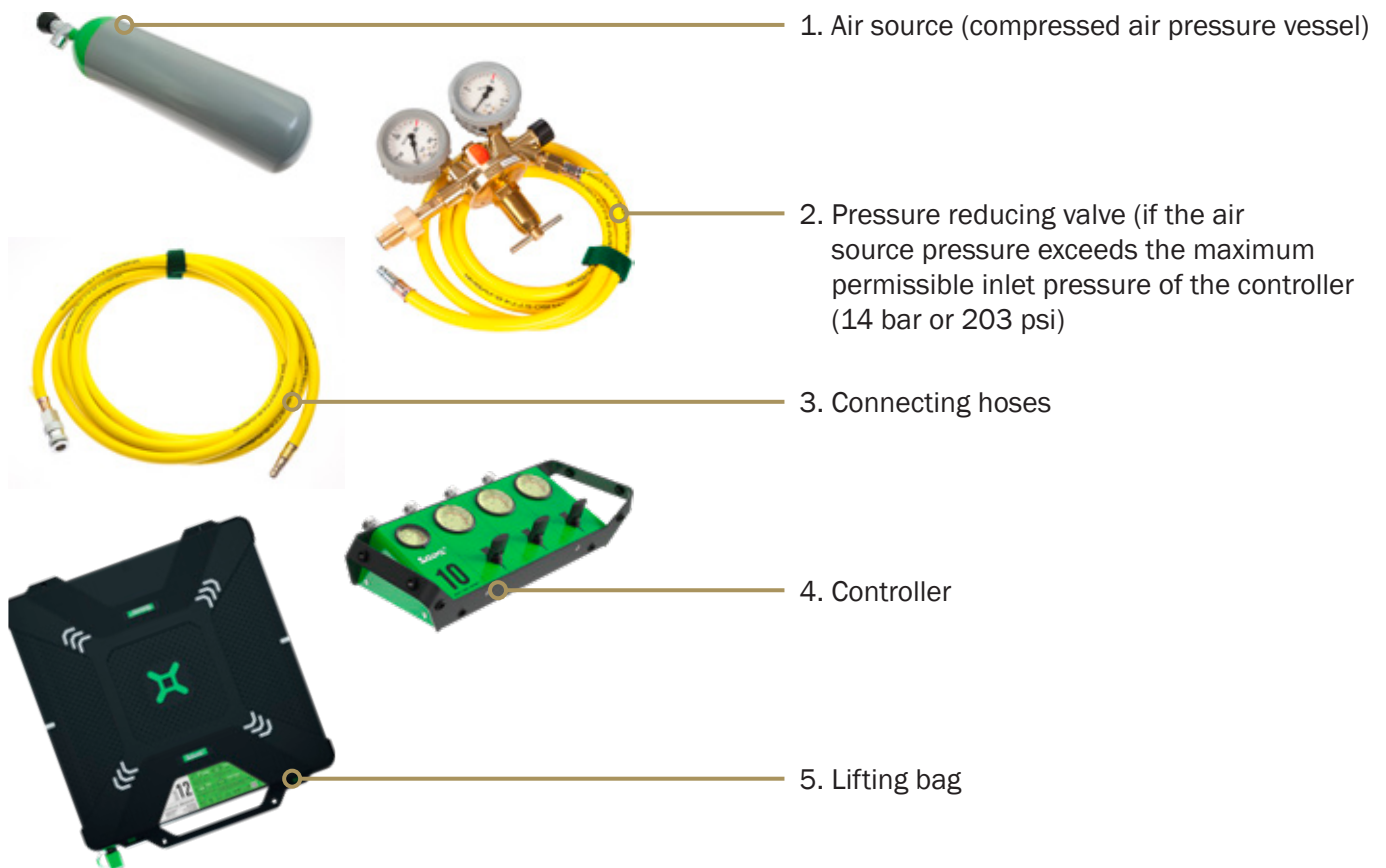

Figure 7.1: Components of the load lifting system using lifting bags.

### 7.1.1. PRESSURE REDUCING VALVE

The pressure reducing valve is used to adjust the pressure of the air source to the specified inlet pressure of the controller. The pressure reducing valve consists of the components shown in Figure 7.2.

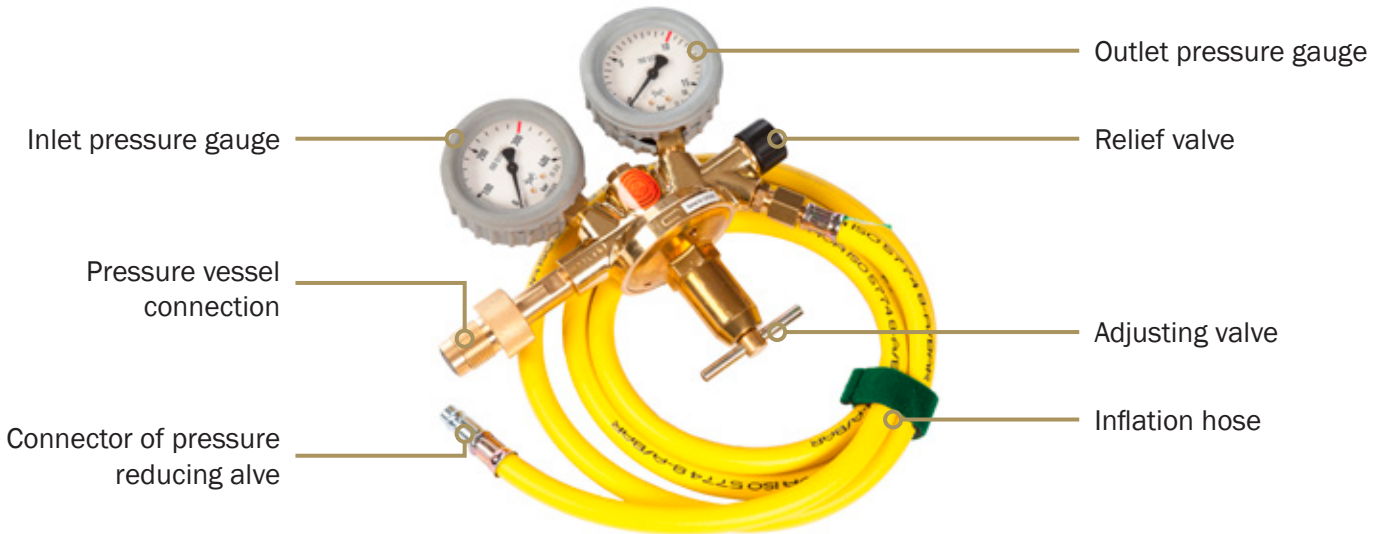

Figure 7.2: Pressure reducing valve – schematic presentation.

The pressure reducing valve is to be screwed directly onto the pressure vessel via the pressure vessel connection, with the valve on the pressure vessel closed. When the valve on the pressure vessel is open, the inlet pressure gauge of the pressure reducing valve on the pressure vessel indicates the pressure in the pressure vessel. The outlet pressure gauge indicates the adjustable pressure of the pressure reducing valve, available only after the relief valve is loosened. The outlet pressure is continuously adjustable throughout the working area by rotating the adjusting valve.

Specific instructions are included with the pressure reducing valve.

### 7.1.2. CONNECTING HOSES

Connecting hoses are used to pneumatically connect lifting bags to the associated pneumatic controller. They consist of components shown in Figure 7.3. They are adapted to the pressure class and may only be used in that specific pressure class. The number on the coupling and the connector of the connecting hose indicates the specific pressure class for the connecting hose. Inflation hoses are fitted with double safety couplings.



Figure 7.3: Connecting hose – schematic presentation.

The month of manufacture of the connecting hose and the serial number (Figure 7.4) are engraved next to the coupling and the connector.



Figure 7.4: Connecting hose – schematic presentation.

### 7.1.3. EXP PANEL CONTROLLER

The controllers are pressure class-specific with a clear indication of the pressure class on the inlet channel. Connect the controller to the air source directly via the safety inlet coupling or indirectly via the pressure reducing valve. The maximum permissible inlet pressure is indicated above the inlet pressure gauge. The inlet pressure gauge indicates the value of the inlet pressure and indirectly displays the air source or pressure vessel indicator. The EXP controller may have two or three outlet channels.

Each outlet channel consists of:

- a control lever for filling and emptying the lifting bag. When up, the lifting bag is being inflated; when down, the lifting bag is being deflated. Once the control lever is released, it assumes its neutral-closed position, which prevents both inflating and deflating the lifting bag;
- a safety valve inside the controller, not visible; when activated, it emits a characteristic acoustic signal;
- an outlet pressure gauge to measure the pressure in the lifting bag; and
- outlet couplings with a two-stage safety opening.

Optional accessories include a neck strap, a dedicated controller case and a light for night work. The design of the controller case allows the controller to be plugged in and conveniently operated directly from the case.

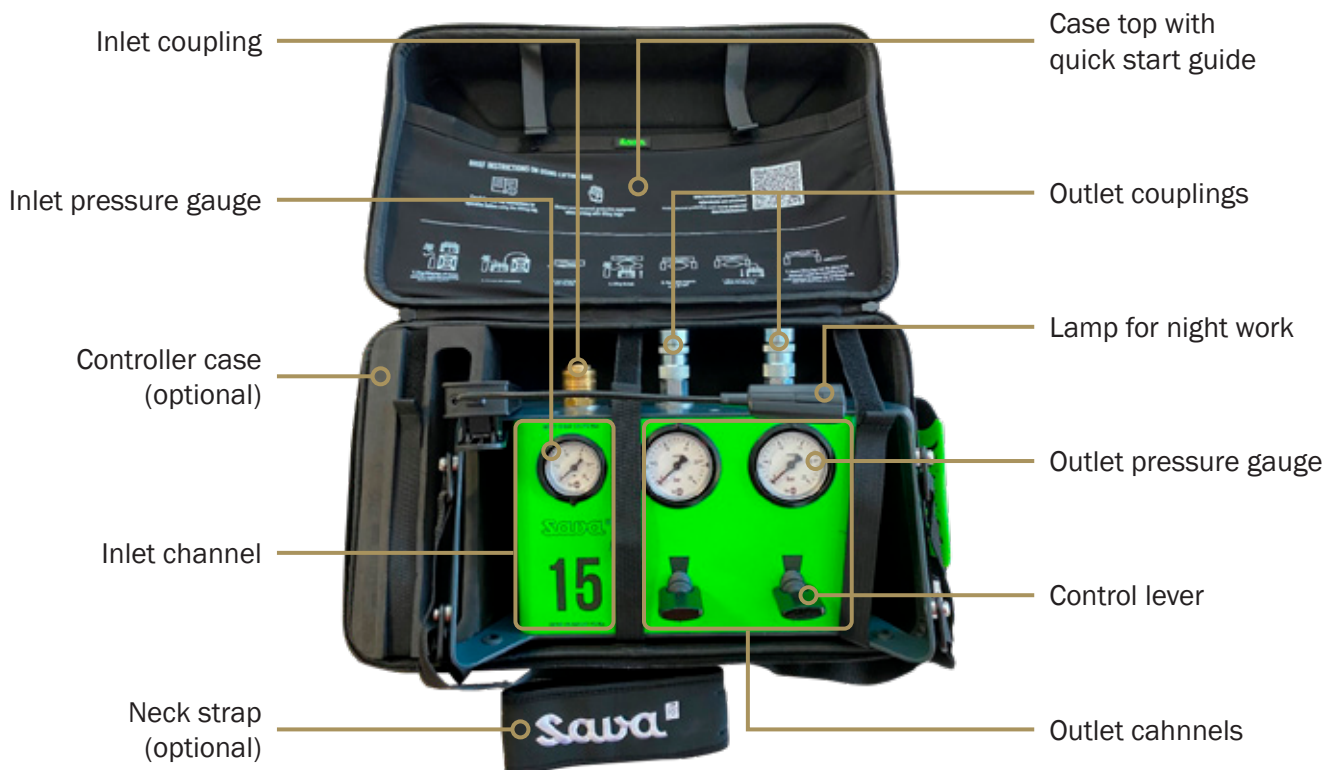

Figure 7.5: EXP controller

Detailed operating instructions are attached with each controller.

## 7.2. PREPARING THE LIFTING BAG FOR LIFTING



Lifting a load with SAVA lifting bags is only permitted using the components listed above.



In case the compressed air contains oil, use an oil separator.

### STEP 1: Position SAVA lifting bag at the place of use

Position SAVA lifting bag at the previously prepared place of lifting procedure. When positioning, follow the rules described in section 5; use mechanical supports for load stabilisation.

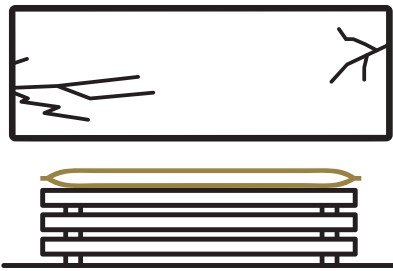

Figure 7.6: Positioning SAVA lifting bag at place of use.

### STEP 1: Position SAVA lifting bag at the place of use

Position SAVA lifting bag at the previously prepared place of lifting procedure. When positioning, follow the rules described in section 5; use mechanical supports for load stabilisation.

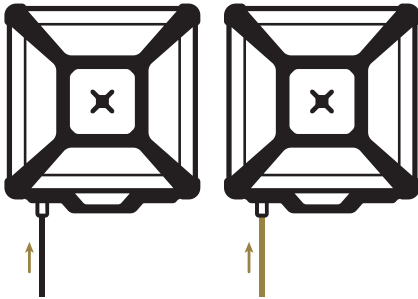

Figure 7.7: Connecting the hose to SAVA lifting bag.

### STEP 2: Connect the hose to SAVA lifting bag

The connecting hoses are of different colours for greater visibility. If you use several lifting bags, use a different colour with each lifting bag.

Connect the hose to the lifting bag. Insert the safety coupling into the connector of the lifting bag as indicated by the arrow in Figure 7.7. so that the connecting coupling engages onto the hose.

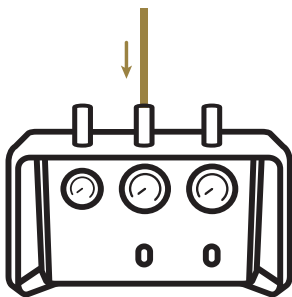

Figure 7.8: Connecting the connecting hoses to the controller.

### STEP 3: Connect the connecting hoses to the controller

Plug the connector of the connecting hose from SAVA lifting bag into the connection coupling on the controller as indicated by the arrow in Figure 7.8. If correctly connected, the connecting coupling on the controller locks in place.

**Fully unroll the connecting hoses. Make sure they are not kinked or folded.**

#### STEP 4: Prepare the air source

The most commonly used air source, also presented in this User Manual, is a compressed air pressure vessel.

In case of using another compressed air source, please note:

- pressure limitation before the inlet to the controller; the maximum inlet pressure to the controller, indicated at the inlet coupling, is limited and depends on the pressure class of the controller;
- the air inlet coupling to the controller; the inflation hose connector should correspond to the type 26 coupling.

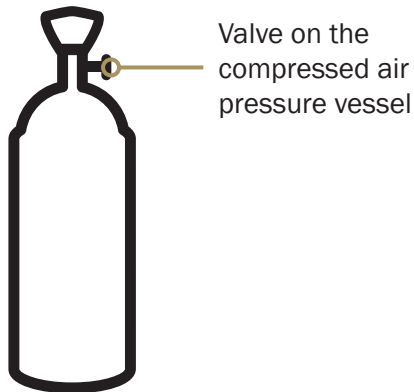

Figure 7.9: Removing the safety plug from the pressure vessel.

##### STEP 4.1: Remove the safety plug from the pressure vessel

Before removing the safety plug, make sure that the valve on the pressure vessel is closed. The valve closes in a clockwise direction.

Unscrew the safety plug and store it.

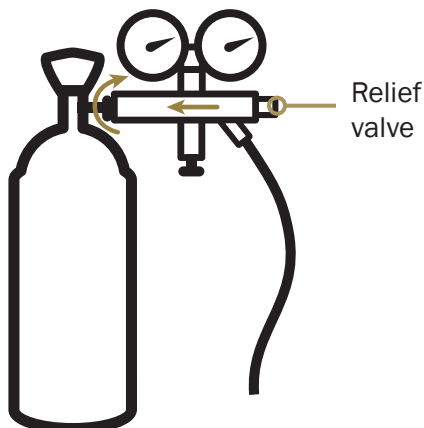

Figure 7.10: Installing the pressure reducing valve.

##### STEP 4.2: Instal the pressure reducing valve on the pressure vessel

Close the relief valve on the pressure reducing valve.

Insert the pressure reducing valve all the way into the connection point on the pressure vessel and tighten the fixing screw as shown in Figure 7.10.

When the pressure vessel is placed on the floor, turn the valve so as to prevent damage during use.

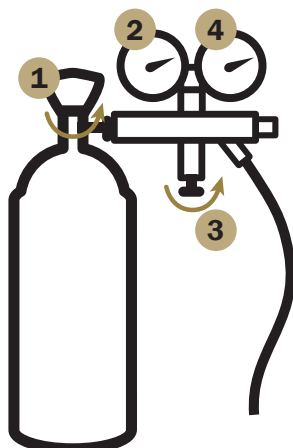

Figure 7.11: Setting the pressure reducing valve.

##### STEP 4.2: Set the pressure reducing valve to the required value

1. Open the valve on the pressure vessel and unscrew it all the way and afterwards half a turn back.
2. The pressure gauge should read 200 or 300 bar (2900 or 4351 psi), depending on the capacity of the pressure vessel.
3. Adjust the required working pressure by rotating the adjusting valve.
4. During adjustment, monitor the set value (12 bar and/or 174 psi) on the outlet pressure gauge.

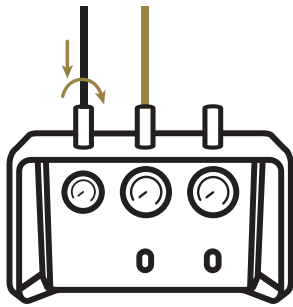

Figure 7.12: Connecting the inflation hose to the controller.

#### **STEP 5: Connect the inflation hose to the controller**

Connect the connector of the inflation hose to the inlet connector of the air source supply on the controller as indicated by the arrow in Figure 7.12. If connected correctly, the coupling on the controller engages. Lock the coupling by rotating its jacket 180° to the left or right.

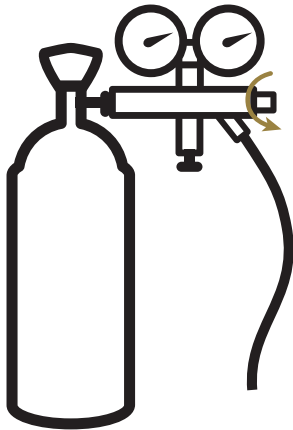

Figure 7.13: Releasing the relief valve

#### **STEP 6: Release the pressure reducing valve**

Release the pressure into the controller by turning the relief valve counter-clockwise.

### **7.3. DISCONNECTING THE LIFTING BAGS**

Lifting bags and other necessary components are under high pressure, so extreme care must be taken when uncoupling. Follow the steps outlined below.

#### **STEP 1: Close the valve on the compressed air pressure vessel**

Close the valve on the compressed air pressure vessel. See Figure 7.9.

#### **STEP 2: Close the relief valve on the pressure reducing valve**

Turn the relief valve on the pressure reducing valve clockwise to cut off the pressure to the controller. See Figure 7.13.

#### **STEP 3: Release the pressure in the lifting bags**

Using the controller, fully release the pressure in the connected lifting bags.

#### **STEP 4: Depressurise the inflation hoses**

Using the controller, release all the air from the inflation hose and valves into the connected lifting bags. Immediately afterwards, empty the lifting bags again.



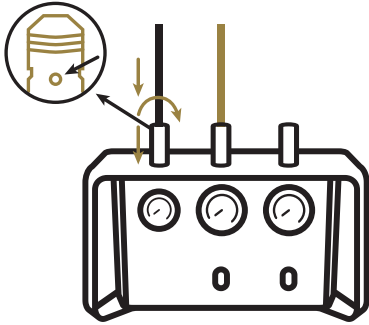

Figure 7.14: Disconnecting the inflation hose from the controller.

#### STEP 5: Disconnect the inflation hose from the controller

Rotate the coupling jacket until the groove on the jacket engages with the pin, as detailed in the upper left corner in Figure 7.14. Push the coupling jacket towards the controller and pull out the connector with the inflation hose.

#### STEP 6: Remove the pressure reducing valve

Loosen the fixing screw on the pressure reducing valve and separate it from the compressed air pressure vessel. See Figure 7.10.

#### STEP 7: Fit the safety plug to the compressed air pressure vessel

Fit the safety plug to the compressed air vessel as shown in Figure 7.9.

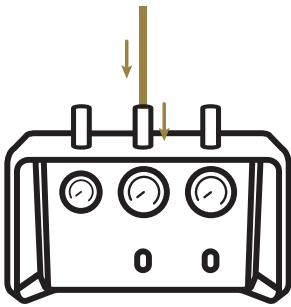

Figure 7.15: Disconnecting the connecting hoses from the controller.

#### STEP 8: Disconnect the connecting hoses from the controller

Push the hose with the connector into the connection towards the controller. Push the coupling jacket towards the controller. Release the connector with the hose so that it pops out of the coupling.

When the connecting hoses are disconnected, they are fully depressurised.

#### STEP 9: Remove the lifting bags from the lifting area

Remove the lifting bags from the lifting area and put them in an easily accessible place.

**WARNING: Do not pull the lifting bag by the connecting hoses.**

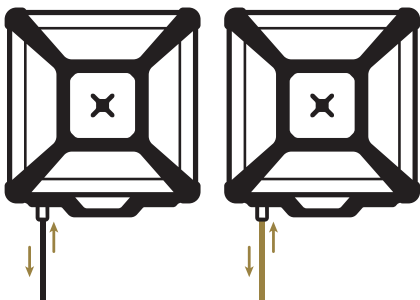

Figure 7.16: Disconnecting the connecting hoses from the lifting bag.

#### STEP 10: Disconnect the inflation hose from the lifting bag

Push the hose with the coupling towards the lifting bag. Pull the coupling jacket away from the lifting bag and drop the hose so that the connector of the lifting bag pops out of the coupling.

## 7.4. LIFTING METHODS

Before starting work, check the area where the lifting bag will be placed.



Remove broken glass, sharp objects and other foreign particles, which could cause damage to or failure of the lifting bag, from the area where the lifting bag is to be placed. Make sure that the lifting bag does not come into contact with sharp edges of sheet metal, the ends of brackets, nails, screws and similar.

When you need to place the lifting bag on a surface where a risk of sliding exists due to:

- oil stains,
- chemicals that could affect the properties of the rubber,
- ice or snow,

sprinkle the surface with sand or other granular material beforehand; alternatively, you can use a rubberised metal plate or dedicated plates for lifting bag protection.

If the lifting bag is used on an unpaved or soft surface, place a solid support, e.g., a rubberised metal plate or wooden plywood, under the bag to ensure stability during lifting and/or to prevent slipping of rubber or load



**WARNING:** It's **MANDATORY** to use a mechanical safety support for all lifting operations. Working under a load supported only by an inflated lifting bag is not permitted under any circumstances.

Place SAVA lifting bag onto the prepared place or built support as shown in Figure 7.6.



**WARNING!** It may happen that some parts of the load are not firmly fixed to the load you want to lift. In such cases, the lifting bag **MUST NOT** be positioned so as to rest on moving parts of the load.

The mechanical safety support must be strong enough to withstand the load it carries. It must be placed on a solid surface to minimise the possibility of its slipping in the circumstances given.

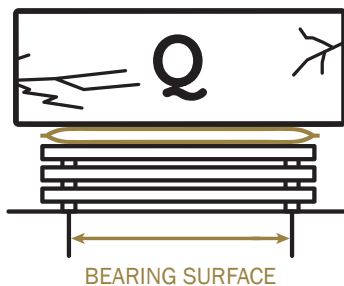

Figure 7.17: Load support structure and marked load-bearing surface



Inflating the lifting bag reduces its contact area and consequently the load capacity. The lifting capacity of lifting bags as a function of the lifting height is shown in Attachment 4.

The maximum load capacity is at the beginning of the lift, when the lifting height is at its lowest (Figure 7.18). As the lifting bag is being inflated, it gradually forms its final shape (Figure 7.19), while the load-bearing surface and hence the load capacity decrease accordingly.

At the maximum lifting height, the load-bearing surface and the load capacity of the lifting bag are the smallest (Figure 7.19).

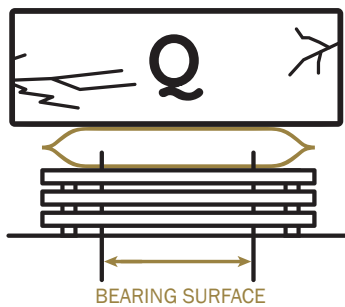

Figure 7.18: Reducing the load-bearing surface with increasing the lifting height.

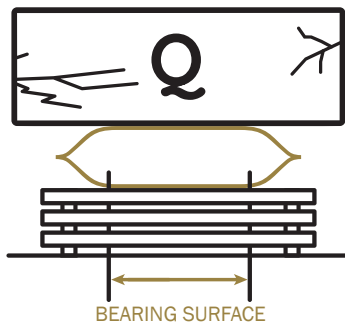

Figure 7.19: Minimum load-bearing surface at maximum lifting height.

#### 7.4.1. LIFTING WITH ONE SAVA LIFTING BAG

Where there is more than 70 mm (2.8”) of space between the ground and the object to be lifted and only one lifting bag available, build a solid support as high as to provide just enough space for insertion of a non-inflated lifting bag. The top surface of the support should allow the non-inflated lifting bag to fully rest on the support.

Slowly inflate SAVA bag to reach the required height and simultaneously add lateral safety supports, see Fig. 7.24.

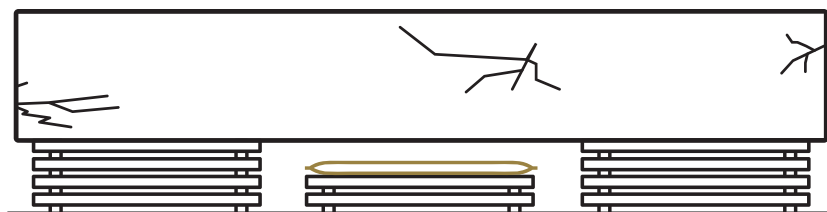

Figure 7.20: Construction of safety supports – non-inflated lifting bag.

Build up the safety support on each side of the load to the point where another layer of support cannot be inserted (Figure 7.20). In this way, the height from which the load would fall down in the event of an unexpected pressure drop in the lifting bag or bag’s collapse.

Insert the lifting bag in the middle of the support with the connector of the lifting bag at the front. Make sure that the top of the lifting bag is fully against the bottom side of the load. An insufficient load-bearing surface may cause the load to slip during inflation or the lifting bag to suddenly and uncontrollably slip out from under the load.

Slowly inflate the lifting bag to reach the required height and simultaneously add lateral safety supports as shown in Figure 7.21.



Do not inflate the lifting bag during building lateral safety support.

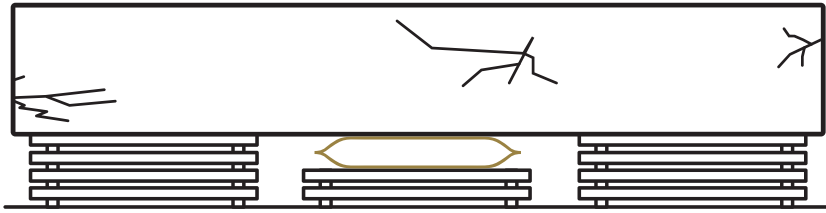

Figure 7.21: Construction of safety supports – inflated lifting bag.

Carefully let the load sit on the safety support. If more working space is needed below the lifting point, remove the lifting bag and the support under it.



When working under the load, the load must be stabilised and the lifting bag fully deflated.

#### 7.4.2. LIFTING WITH MULTIPLE LIFTING BAGS TO INCREASE LOAD CAPACITY

The load capacity of lifting bags can be increased by combining two lifting bags placed one next to the other and inflating them simultaneously, as shown in Figure 7.22. The increased load capacity is twice the load capacity of the smaller lifting bag.

*Example:*

*The combination of two VEGA Flat 10/17 flat lifting bags, placed side by side and inflated simultaneously, has twice the load capacity of the bag (VEGA Flat 10), namely 20.0 t (22 US t), which is sufficient to lift a load of 15 t (16.5 US t).*

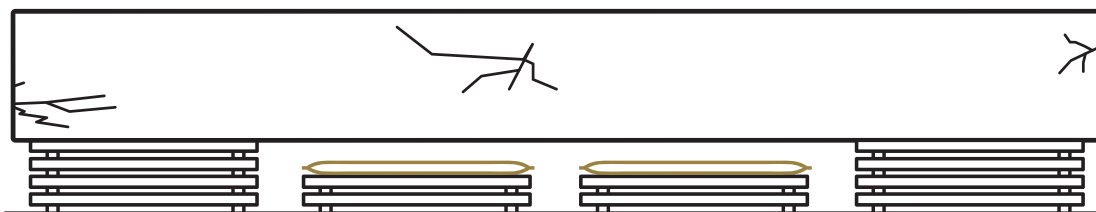

Figure 7.22: Combination of two lifting bags placed side by side to increase the load capacity.

#### 7.4.3. LIFTING WITH MULTIPLE LIFTING BAGS TO INCREASE LIFTING HEIGHT

Increasing the lifting height is achieved by placing up to three same size Vega flat lifting bags on top of each other, as shown in Figure 7.23. The total lifting height of such a combination is equal to the sum of the lifting heights of the individual lifting bags. The load capacity of the combination is equal to the capacity of one lifting bag.

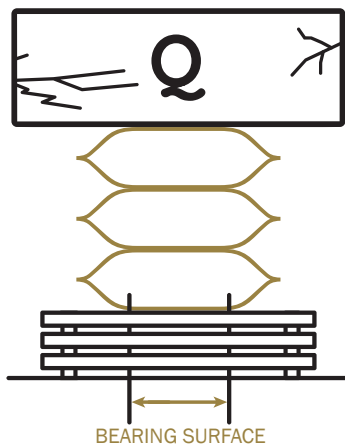

Figure 7.23: Combination of three lifting bags to increase the lifting height.



**WARNING:** If the required lifting height cannot be determined, choose the largest lifting bag available that can be inserted under the load.

*Example:*

The combination of two VEGA Flat 20/17 (17 cm/6.9") lifting bags, placed on top of each other gives a total lift of 34 cm (13.8").



For VEGA Flat type lifting bags, the combination to increase the lifting height may consist of a **MAXIMUM** of **THREE** lifting bags.

When combining to increase the lifting height, place the lifting bags one on top of the other with the plugs at the front, as shown in Figure 7.24.

Construct safety supports and a support bed for the lifting bag, the same as for lifting with one lifting bag (section 7.4.1).

When lifting loads with two or three lifting bags stacked on top of each other, first inflate the lower SAVA lifting bag and proceed in order towards the top. When lowering the load, follow the reverse order.



Figure 7.24: Combining flat lifting bags of different sizes to increase the lifting height.

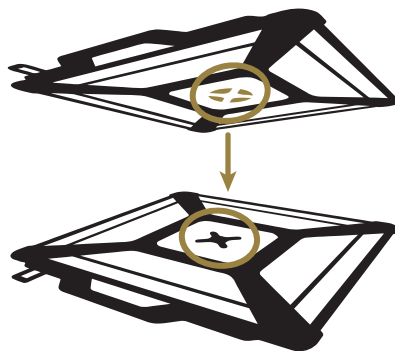

Figure 7.25: Interlocking the bags combined to increase the lifting height.

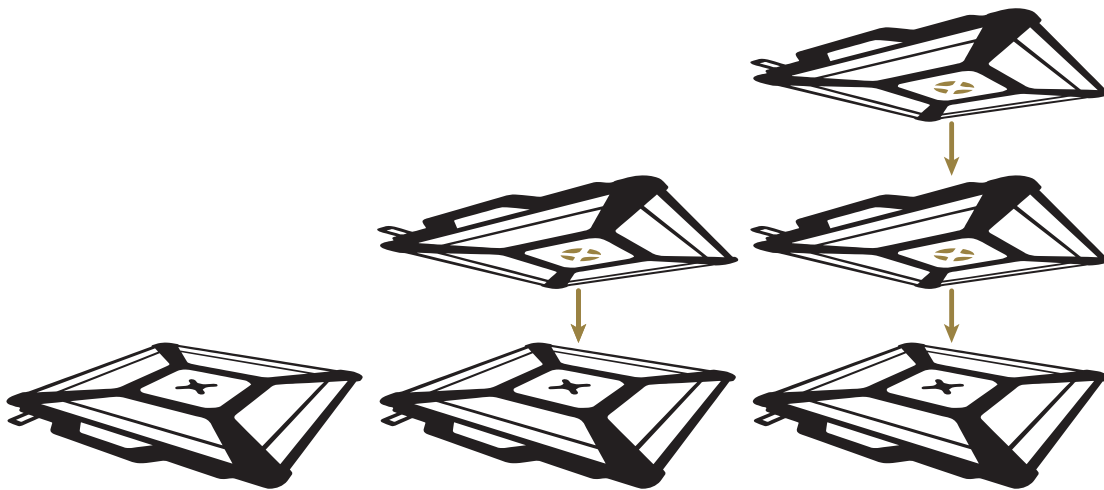

Figure 7.26: Combining flat lifting bags to increase the lifting height.

#### 7.4.4. LIFTING OBJECTS OF UNUSUAL SHAPES

##### 7.4.4.1 Lifting pipes and profiles

Problems arise when lifting pipes and profiles, as they do not contact the entire available load-bearing surface of the lifting bag. The lifting bag may also be damaged if it is twisted or contacted by pointy or sharp parts of the object to be lifted.

Therefore, in this case, place a protective plate or plywood between the lifting bag and the lifting object, as shown in Figure 7.27. This will distribute the lifting force evenly over the entire lifting surface of the lifting bag.

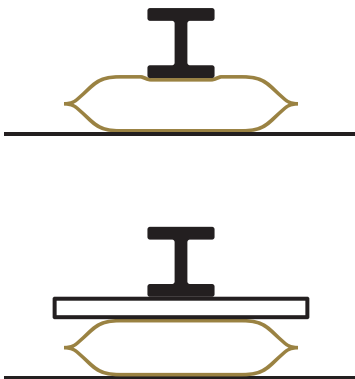

Figure 7.27: Supporting the SAVA lifting bag with plywood when lifting profiles and pipes.

##### 7.4.4.2 Lifting cylindrical objects



It is not possible to lift cylindrical objects of larger dimensions, such as tanks, with only one lifting bag. If the object cannot be securely fixed, it will roll to the side as soon as the lifting bag starts to inflate and gets its characteristic spherical shape.

Therefore, lift cylindrical objects with at least two lifting bags, one on each side of the object, as shown in Figure 7.28. Inflate both lifting bags evenly and simultaneously.

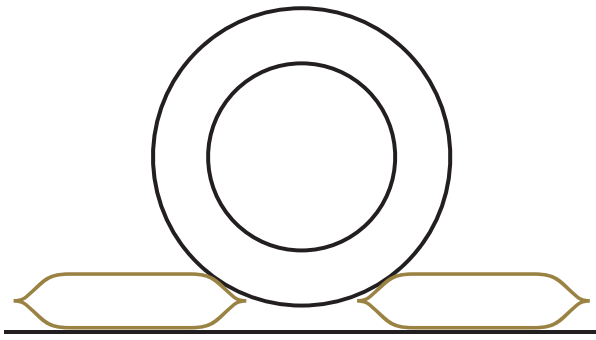

Figure 7.28: Lifting cylindrical objects of large diameters.

#### 7.4.4.3 Separating and moving with sava lifting bag

Lifting bags can also be used to separate and move objects. Problems can arise if the object to be pushed has a thin wall, which the lifting bag could bend or even break due to high pressure acting on the wall. Therefore, lean the lifting bag against a bar, pillar or any other solid and rigid element. If this is not possible, place a rubberised metal plate or thick plywood between the lifting bag and the object to distribute the pushing force over a larger area, as shown in Figure 7.29.

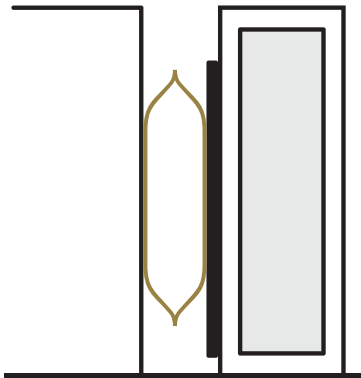

Figure 7.27: Supporting the SAVA lifting bag with plywood when lifting profiles and pipes.

## 8.0. UNEXPECTED SITUATIONS



In the event that, while working with lifting bags, you notice any damage to the lifting bag, inflation and connecting hoses, and other components of the lifting system that could compromise safety, stop the work immediately and replace the damaged component. The use of lifting bags and hoses on which cracks, bulges, unusual deformations and similar are observed is NOT permitted.



If you estimate that lifting loads with SAVA lifting bags poses a danger to rescued persons or the rescue team, stop the work. Consult the rescue professionals on applying an alternative method of lifting (crane, towing, etc.).



If the lifting bag bursts, a very loud bang is released.

Table 3: Unexpected situations.

| UNEXPECTED SITUATION   | CONSEQUENCE  | NECESSARY ACTION  |
|--|--|---|
| <p>The pressure in the lifting bag drops suddenly.</p> <p>The lifting bag and the load lower uncontrollably.</p> | <p>The load lowers to the support.</p> <p>When the lifting bag collapses, a very loud bang is heard.</p> | <p>If you identify a fault in one of the components, replace it. Otherwise, replace all components.</p>   |
| <p>The lifting bag does not inflate even though the pressure gauge shows the correct working pressure.</p>       | <p>The load cannot be lifted.</p>  | <p>Check again if a suitable lifting bag has been chosen for the lift.</p>  |
| <p>Despite activation of the filling valve on the lifting bag, the working pressure is not reached.</p>          | <p>The load cannot be lifted.</p>  | <p>Check the lifting bag inflation system. Inspect the individual components and, if you identify a fault in one of them, replace that component or all components of the system.</p>   |
| <p>Uncontrolled movement of the load or lifting bag.</p>   | <p>The load is no longer balanced.</p>   | <p>Lower the load to the basic position or the support with extreme care, checking beforehand and re-arranging the place of use if necessary. Then recheck the lifting bags for correct positioning.</p>  |
| <p>Uncontrolled exceeding of the working pressure.</p>   | <p>Destruction of the lifting bag accompanied by a loud sound.</p>                                       | <p> The lifting system is protected by safety valves. If the working pressure is nevertheless exceeded, immediately stop lifting and carefully lower the load onto the prepared supports.</p> <p>Check the lifting bag inflation system. Inspect the individual components and, if a fault is detected in any of them, replace that component, otherwise replace all components of the system.</p> |

## 9.0 ACCESSORIES

Accessories are available for purchase and use with the SAVA lifting bag system. A list of accessories is attached.

Please contact your dealer or visit their website for more information.

## 10.0. MAINTENANCE AND CLEANING

Clean and inspect high-pressure lifting bags and accessories after each use. Always use personal protective equipment when cleaning, namely at least safety goggles, gloves and protective footwear.





## 10.1. MAINTENANCE AND CLEANING OF SAVA LIFTING BAGS AFTER USE

Clean and inspect lifting bag after each use. Oil and grease stains cause the lifting bag to slip, while pieces of dirt in the connector prevent its connection to the hose and obstruct the flow of air or water.

Roughly clean the lifting bag by holding it upright with the connector at the top, shake and tap it on the floor.

Check the opening of the connector. If it is filled with dirt, remove it with a thin wire. Pull the dirt out of the connector, do not push it into the lifting bag.

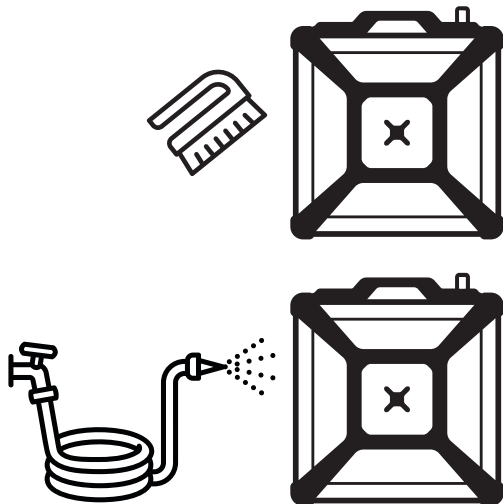

Use a stiff-bristle brush to remove adhering dirt from the surface of the lifting bag. Move the brush in different directions. The use of sharp objects to remove dirt is not permitted.

Once adhering dirt is removed, splash a mild solution of dishwashing detergent and warm water on the stains on the lifting bag and brush off any remaining dirt from the surface with a stiff-bristle brush.

Do not use petrol, thinner, alcohol or aggressive cleaning agents.

Rinse the lifting bag with clean cold water. A strong jet of water will remove any remaining dirt and soap scum that may remain on the bag's surface.



The use of a high-pressure cleaner is NOT allowed.  
Do not dry lifting bags in a dryer or with heating devices.

Hold the lifting bag upright and wipe the connector with a clean cloth. Leave the lifting bag to air dry.

Carefully inspect the clean and dry lifting bags, following the preventive maintenance instructions and Table 4 (see section 11).

## 10.2. MAINTENANCE OF INFLATION AND CONNECTING HOSES AFTER USE

After each use, clean the inflation and connecting hoses with a mild solution of dishwashing detergent and warm water. Rinse the hoses with clean cold water.

Check the opening in the connector and coupling. If they are filled with dirt, remove it with a thin wire. Pull the dirt out of the connector or coupling. Do not push dirt into the hose.

Wipe the hoses with a dry cloth.



The use of a high-pressure cleaner is NOT allowed.  
Do not dry inflation and connecting hoses in a dryer or with heating devices.

Carefully inspect the cleaned and dry hoses (see section 11).

### 10.3. MAINTENANCE OF CONTROLLERS AFTER USE

After use, clean and maintain the controllers in accordance with the Operating instructions for the controller.

## 11.0. PREVENTIVE MAINTENANCE

---

Preventive maintenance includes the mandatory inspection of lifting bags with associated accessories, as well as testing and replacing damaged components.

When carrying out preventive maintenance, please also observe local regulations.

Use personal protective equipment when inspecting and testing. Firefighters and rescue team members should use a complete set of protective equipment required for their work. Other users should wear a safety helmet, safety glasses and gloves, and protective footwear. We recommend that you keep a written record of the results of inspections and tests, and keep the records for the lifetime of the product.



Follow the instructions for safe working.



If in doubt about the safety of the test, discontinue the test immediately and consult the manufacturer or their authorised representative on the next steps.



Functional tests carried out under pressure may only be carried out after a visual inspection has been conducted out and no defects have been found.



If the last periodic test has not been carried out within the prescribed interval, or if the lifting bag or its accessories have failed to pass this test, or if there is any doubt as to the safe and reliable use of the lifting bag and its accessories, the use of the lifting bag and its accessories may be dangerous and is therefore not permitted. In this case, the prescribed periodic test must be carried out prior to conducting the functional test.



If, during a visual inspection or functional test, damage or leaks are detected in SAVA lifting bags or damage to or malfunctions of the equipment, the faulty lifting bags or equipment **MUST NOT** be used.



In addition to the inspection intervals specified by the manufacturer, please also observe the requirements of valid local legislation.

## 11.1. INSPECTION INTERVALS

### SAVA lifting bag

Table 4: SAVA lifting bags – inspection intervals.

| INSPECTION        | INSPECTION INTERVAL  | OPERATOR  | PROCEDURE       |
|-------------------|--|---|-----------------|
| Visual inspection | <ul style="list-style-type: none"><li>• After each use</li><li>• Annually</li></ul>  | Person qualified to work with SAVA lifting bags         | Section 11.2.1. |
| Functional test   | <ul style="list-style-type: none"><li>• After each use</li><li>• Annually</li></ul>  | Person qualified to work with SAVA lifting bags         | Section 11.2.2. |
| Periodic test     | 5 <sup>th</sup> , 10 <sup>th</sup> , 13 <sup>th</sup> year after manufacture, or when in doubt about the safety and reliability of the product | Manufacturer or a person authorised by the manufacturer |                 |

### Pressure reducing valve

Table 5: Pressure reducing valve – inspection intervals.

| INSPECTION        | INSPECTION INTERVAL  | OPERATOR  | PROCEDURE       |
|-------------------|--|---|-----------------|
| Visual inspection | <ul style="list-style-type: none"><li>• After each use</li><li>• Annually</li></ul>  | Person qualified to work with SAVA lifting bags         | Section 11.2.3. |
| Functional test   | <ul style="list-style-type: none"><li>• After each use</li><li>• Annually</li></ul>  | Person qualified to work with SAVA lifting bags         | Section 11.2.4. |
| Periodic test     | 5 <sup>th</sup> , 10 <sup>th</sup> , 13 <sup>th</sup> year after manufacture, or when in doubt about the safety and reliability of the product | Manufacturer or a person authorised by the manufacturer |                 |

### Connecting hoses

Table 6: Inflation and connecting hoses – inspection intervals.

| INSPECTION        | INSPECTION INTERVAL  | OPERATOR  | PROCEDURE       |
|-------------------|--|---|-----------------|
| Visual inspection | <ul style="list-style-type: none"><li>• After each use</li><li>• Annually</li></ul>  | Person qualified to work with SAVA lifting bags         | Section 11.2.5. |
| Functional test   | <ul style="list-style-type: none"><li>• After each use</li><li>• Annually</li></ul>  | Person qualified to work with SAVA lifting bags         | Section 11.2.6. |
| Periodic test     | 5 <sup>th</sup> , 10 <sup>th</sup> , 13 <sup>th</sup> year after manufacture, or when in doubt about the safety and reliability of the product | Manufacturer or a person authorised by the manufacturer |                 |

### EXP controller

Table 7: EXP controller – inspection intervals.

| INSPECTION        | INSPECTION INTERVAL  | OPERATOR  | PROCEDURE       |
|-------------------|--|---|-----------------|
| Visual inspection | <ul style="list-style-type: none"><li>• After each use</li><li>• Annually</li></ul>  | Person qualified to work with SAVA lifting bags         | Section 11.2.7. |
| Functional test   | <ul style="list-style-type: none"><li>• After each use</li><li>• Annually</li></ul>  | Person qualified to work with SAVA lifting bags         | Section 11.2.8. |
| Periodic test     | 5 <sup>th</sup> , 10 <sup>th</sup> , 13 <sup>th</sup> year after manufacture, or when in doubt about the safety and reliability of the product | Manufacturer or a person authorised by the manufacturer |                 |

## 11.2. TEST PROCEDURES

### 11.2.1. VISUAL INSPECTION OF SAVA LIFTING BAG

Clean and dry SAVA lifting bags before visual inspection.

Visually check the bags and pay special attention to the presence of any:

- abnormal bulges,
- air pockets,
- punctures,
- cuts,
- worn parts,
- other mechanical damage.

Inspect the connector and:

- check it for wear or damage,
- test the connecting hose for connectivity,
- check for the presence and any damage to the protective cap that could affect its functionality.

Check the data on the label of SAVA lifting bag for legibility.

Connect the unloaded SAVA lifting bag in accordance with section 7.2. and fill it with a pressure of 0.2 times the working pressure.

Visually check the lifting bag again, follow the second paragraph of this section.

Apply soapy water with a brush over the entire surface of the lifting bag, including the connector. Visually check the lifting bag and the connector for leaks.

If any damage or defect is detected, mark it with chalk. Consult the manufacturer or their authorised representative about the severity of the damage and further use of the lifting bag.



If SAVA lifting bag fails to pass the visual inspection, remove it from service. The use of a lifting bag that has failed the visual inspection is NOT allowed. In case of doubt about the severity of the damage, consult the manufacturer or their official representative.

### 11.2.2. FUNCTIONAL TEST OF LIFTING BAGS



If the lifting bag fails to pass the visual inspection, it is NOT permitted to carry out the functional test.



If in any doubt as to whether a functional test is safe to carry out, consult the manufacturer or their authorised representative prior to carrying out the functional test.

Connect the loaded SAVA lifting bag in accordance with section 7.2. Fill SAVA lifting bag to a pressure of 0.5 times the working pressure.

After one minute, top up to 0.5 times the working pressure if necessary.

Read the pressure value on the pressure gauge. After 10 minutes, repeat the reading. The lifting bag has passed the leak test if the pressure difference does not exceed 10% of the initial value.



If SAVA lifting bag fails to pass the functional test, remove it from service. The use of a lifting bag that has failed the functional test is NOT permitted. In case of doubt as to the severity of the damage found, consult the manufacturer or their official representative.

### 11.2.3. VISUAL INSPECTION OF PRESSURE REDUCING VALVE

Visually check the following components:

- the threaded part of the pressure vessel connector for any damage,
- rubber gasket in the pressure vessel connector for presence and damage,
- pressure gauges for damage and the maximum working pressure marking for readability,
- protective caps on the gauges for damage that could affect its functionality,
- relief valve for any damage,
- inflation hose for any damage, e.g., tears, punctures or other damage such as slightly hardened areas and effects of contact with aggressive media.

### 11.2.4. FUNCTIONAL TEST OF PRESSURE REDUCING VALVE

Connect the pressure reducing valve to a standard pressure vessel with a capacity of 6 l and a pressure of 300 bar. The pressure vessel should be full. Close the pressure relief valve.

Open the valve on the pressure vessel. The left-hand pressure gauge should read 300 bar.

Apply soapy water with a brush to the connection area of the pressure reducing valve with the pressure vessel and check for leaks.

Move the adjusting valve to gradually reduce the outlet pressure indicated on the right-hand gauge to 0 bar and gradually release the pressure in the pressure reducing valve. Rotate the adjusting valve in the opposite direction until the maximum value indicated on the right-hand gauge (12 bar) is reached. The adjusting valve enables value setting throughout the working range. The adjusting valve should move smoothly throughout the operating range.

Apply soapy water to the connector with a brush and check the relief valve for leaks.

Connect the inflation hose to the controller. Slowly open the relief valve until it is fully open. The relief valve must be moving smoothly at all times. The pressure gauge on the controller must show the same value as the right-hand pressure gauge of the pressure reducing valve. Apply soapy water with a brush to the inflation hose and to the connection areas of the hose with the pressure reducing valve and the hose with the controller. Check the hoses and the connection areas for leaks.

### 11.2.5. VISUAL INSPECTION OF CONNECTING HOSES

Visually check for any damage:

- connection couplings,
- connector,
- hoses, e.g., tears, punctures or any other damage such as slightly stiffened areas and the effects of contact with aggressive media.

### 11.2.6. FUNCTIONAL TEST OF CONNECTING HOSES

Connect the controller and the lifting bag with the connecting hose as described in section 7.2. Inflate the lifting bag to a pressure of 0.2 times the working pressure. Apply soapy water with a brush to the connection areas and the connecting hose, and check for leaks.

### 11.2.7. VISUAL INSPECTION OF THE EXP CONTROLLER

Visually check for any damage:

- connecting inlet couplings,
- connecting outlet couplings,
- inlet pressure gauge,
- outlet pressure gauges,
- housing,
- neck strap and its attachment to the controller (optional),
- lamps for controller lighting (optional).

### 11.2.8. FUNCTIONAL TEST OF THE EXP CONTROLLER

Connect the inflation hose of the pressure reducing valve as described in section 7.2. and check the operation of the inlet coupling.

Connect the controller and the lifting bag with the connecting hose as described in section 7.2 and check the operation of the outlet couplings.

Set the control levers first to the lifting position and afterwards to the lowering position. The levers should move smoothly. If the control lever is in the lifting position, the connected SAVA lifting bag must be inflating.

**WARNING: Do not exceed a pressure of 0.2 times the working pressure in the lifting bag.**

#### 17.2.8.1 Functional test of controller pressure gauges

Using reference pressure gauges, test the performance of the controller's pressure gauges.

Check the function of:

- the inlet pressure gauge, where the outlet pressure gauge of the connected pressure reducing gauge can be used as a reference gauge,
- the outlet pressure gauges, for which a dedicated reference pressure gauge is required

#### 17.2.8.2 Functional test of safety valve

Connect the pressure reducing valve as described in section 7.2.

Push the control lever to the lifting position and gradually increase the pressure in the controller until the safety valve opens and/or the value 1.1 times the working pressure of the controller is exceeded.

**WARNING: The outlet pressure of the pressure reducing valve must be set to the maximum inlet pressure into the controller.**



The safety valve is free from defect if it is activated within a range of -0 to +10 % of the controller's working pressure. The activated safety valve emits a characteristic sound.

#### 17.2.8.3 Functional test of controller lighting lamp

Place the lamp on the controller and switch it on. When switched on, the light comes on.

## 12.0. FAULT IDENTIFICATION AND TROUBLESHOOTING

Table 8: Fault identification and troubleshooting

| UNEXPECTED SITUATION   | CONSEQUENCE   | NECESSARY ACTION   |
|--|---|--|
| Inlet pressure gauge of the pressure reducing valve does not indicate sufficient pressure                                | The pressure vessel is empty.<br>The valve on the pressure vessel is closed.  | Replace the pressure vessel.<br>Open the valve on the pressure vessel.   |
| The required pressure cannot be set on the outlet pressure gauge of the pressure reducing valve.                         | The pressure in the pressure vessel has blocked the adjusting valve.<br>Failure of the adjusting valve.<br>Failure of the outlet pressure gauge.      | Open the relief valve for a short time (1 s) and try to set the pressure again.<br>Replace the pressure reducing valve.<br>Replace the pressure reducing valve.  |
| The inflation hose of the pressure reducing valve cannot be properly inserted into the controller's connection coupling. | There is dirt in the connector or coupling.<br>The connector or coupling is damaged.  | Clean the connector and coupling.<br>Replace the pressure reducing valve or controller.  |
| The connecting hose cannot be properly inserted into the controller's connection couplings.                              | There is dirt in the connectors or couplings.<br>The connectors or couplings are damaged  | Clean the connectors and couplings.<br>Replace the hose or controller.   |
| The lifting bag does not inflate despite the activated lever for lifting.  | Failure of the safety valve.<br>The connector or coupling is blocked with dirt.<br>The inflation hose or connecting hoses are not properly connected. | Replace the controller.<br>Clean the connector or coupling.<br>Check and re-connect the inflation or connecting hoses.   |
| The lifting bag does not deflate despite the activated lever for lowering.   | The coupling's connectors are blocked with dirt.  |  <b>WARNING!</b><br><b>The following procedure requires extreme caution!</b> <ol style="list-style-type: none"> <li>1. Check again if the load is properly and securely supported.</li> <li>2. Close the valve on the pressure vessel.</li> <li>3. Deflate all lifting bags connected to the controller.</li> <li>4. Disconnect the connecting hose on the lifting bag which is not deflating very carefully</li> <li>5. If the lifting bag is still not deflating, use a metal needle, from a safe distance, to clean and/or release the connector of the lifting bag.</li> </ol> |
| The last periodic test as specified by the manufacturer has not been carried out.  | Failure to follow the instructions for use.   |  <b>WARNING!</b><br><b>The use of the lifting bag system that has not been properly tested is strictly forbidden.</b> <p>Before using the lifting bag system, ensure that a periodic test is carried out in accordance with the manufacturer's requirements.</p>   |

Trelleborg is a world leader in engineered polymer solutions that seal, damp and protect critical applications in demanding environments. Its innovative solutions accelerate performance for customers in a sustainable way.

Trelleborg Industrial Solutions is a leading supplier of polymer-based critical solutions in selected industrial application areas and infrastructure projects.

**ISO 9001**  
**ISO 14001**  
**ISO 45001**



**Trelleborg Slovenija d.o.o.**  
PG Environmental protection products



Škofjeloška cesta 6, 4000 Kranj, Slovenija

phone: +386 (0)4 206 6388  
e-mail: [tis.kra.info.eko@trelleborg.com](mailto:tis.kra.info.eko@trelleborg.com)  
fax: +386 (0)4 206 6390



[www.trelleborgslovenija.com](http://www.trelleborgslovenija.com)  
[trelleborg.com/seals-and-profiles](http://trelleborg.com/seals-and-profiles)





# Attachments to the user manual



## LIST OF ATTACHMENTS

---

**ATTACHMENT 1:** WARRANTY TERMS AND CONDITIONS

**ATTACHMENT 2:** QUICK START GUIDE

**ATTACHMENT 3:** MEDIA RESISTANCE TABLE

**ATTACHMENT 4:** TECHNICAL DATA

**ATTACHMENT 5:** LIST OF ACCESSORIES

# ATTACHMENT 1: WARRANTY STATEMENT

---

## 1. GENERAL TERMS AND CONDITIONS

- 1.1. These warranty terms and conditions apply as for Environmental protection and rescue products, manufactured by TBSLO, Product Area Environmental protection and rescue products (hereinafter Products). If any provision of this warranty would be contrary to any mandatory legal provisions in any particular jurisdiction, such provision shall apply to a maximum extent as provided for by such mandatory legal provisions.
- 1.2. The Products which may be sold by TBSLO Product Area Environmental protection and rescue products but are not manufactured by it are not covered by this warranty and are sold exclusively with warranties, if any, by their original manufacturer.

## 2. MANAGEMENT OF THE PRODUCTS

- 2.1. In order to claim a remedy pursuant to this warranty, purchaser must conform to the instructions for management of the Products, available at <https://www.trelleborgslovenija.com/en/products-and-solutions/environmental-protection-and-rescue-products/downloads/manuals>.

## 3. WARRANTY

- 3.1. TBSLO warrants to the purchaser that for a period of twelve (12) months as of delivery of the Products, such Products shall be free from defects in material and workmanship, subject to normal use and management of the Products, including, among others, proper storage. For high-pressure lifting bags, the warranty period amounts to thirty-six (36) months as of delivery.
- 3.2. This warranty shall be in lieu of any other warranties, express or implied, including, but not limited to, any warranty of merchantability or fitness for a particular purpose.

## 4. EXCLUSION OF WARRANTY

- 4.1. Warranty shall be excluded in cases where the Products have not been used for the ordinary purpose or have been exposed to abnormal conditions such as, but not limited to misuse, mishandling (such as, but not limited to, cuts, tears, vandalism, fire, wilful destruction, improper installation and/or improper maintenance, misapplication), use of unauthorized components or attachments or if adjustments or repairs have been performed by anyone other than TBSLO or its authorized agents.
- 4.2. Warranty shall also be excluded and TBSLO shall not be held liable in case of force majeure, such as, but not limited to:
  - war or threat of war, sabotage, insurrection, riots or requisition;
  - all laws, restrictions, regulations, by-laws, prohibitions or any other measures by the governmental, parliamentary or local bodies;
  - import and export regulations or embargo;
  - strikes, lock-outs or other industrial measures or trade disputes (if including Manufacturer's employees or third party);
  - difficulties with supply of raw materials, work force, fuel, parts or machinery;
  - power blackout, break of machinery.

- 4.3.** TBSLO shall not be held liable for any deficiencies in Products manufactured according to drawings, designs, project drafts and/or specifications provided by the purchaser.
- 4.4.** Normal wear and tear are not covered by this warranty.

## **5. MAKING A WARRANTY CLAIM**

- 5.1.** Purchaser is obliged to take delivery of the Products and perform a careful inspection of the Product upon delivery.
- 5.2.** Any claim by the purchaser with reference to the Products shall be deemed waived unless submitted in writing to TBSLO within the earlier of (I) eight days as of the discovery of the defect, or (II) twelve months as of the date of delivery of the Products or thirty-six (36) months as of delivery of high-pressure lifting bags. Identifying the defect is deemed to have occurred when a defect could have reasonably been detected by the purchaser.
- 5.3.** Claim must contain at least the following information:
- part number,
  - serial number,
  - description of defect,
- and must be substantiated by adequate evidence, such as pictures etc. Upon request, TBSLO must be allowed to inspect the Product.
- 5.4.** To obtain performance under this warranty, any products suspected of having a manufacturing defect in materials or workmanship shall be returned freight prepaid for inspection to TBSLO, Product Area Environmental protection and rescue products, Škofjeloška c. 6, 4000 Kranj, Slovenia.

## **6. REMEDIES**

- 6.1.** TBSLO shall decide on a claim within forty–five days of receipt of the complete documentation and Product pursuant to art 5.
- 6.2.** Providing TBSLO acknowledges the claim as justified, it shall, at its discretion, either:
- repair the Product,
  - replace those components of the Product which are defective,
  - replace the Product, if repair is not possible or reasonable,
  - reimburse the consideration for the Product or its components which are defective.
- 6.3.** Whenever TBSLO repairs or replaces the Product at its expense or reimburses the purchase price, it shall reimburse the purchaser, with a credit note, the same surface freight amount the purchaser had when returned the Product to TBSLO.

**6.4.** Remedies pursuant to this article 6 shall constitute the sole and exclusive remedy in the event of a breach of warranty. For the avoidance of doubt, TBSLO shall not be liable for any incidental, consequential and/or non-pecuniary damages or damages having a comparable effect. TBSLO's aggregate liability in respect of any and all losses arising under or in connection to the contract/ purchase order/any similar document that is the basis for sale of Products, shall be limited to an amount equal to the invoiced price for the Products supplied. Any exclusions or limitations of liability are agreed to be extended for the benefit of all entities within TBSLO's group.

## **7. CLOSING PROVISIONS**

- 7.1.** No statement or action by Trelleborg Slovenija, whether express or implied, other than set forth herein, shall constitute a warranty.
- 7.2.** Any applicability of general terms and conditions used by the purchaser, wherever stated, is hereby explicitly excluded, notwithstanding any provisions of such general terms and conditions to the contrary.
- 7.3.** This warranty statement is subject to the laws of the Republic of Slovenia, with the exclusion of its conflict of law principles.

Kranj, 8 January 2019  
Trelleborg Slovenija, d.o.o  
PRODUCT AREA ENVIRONMENTAL  
PROTECTION AND RESCUE PRODUCTS

## ATTACHMENT 2: QUICK START GUIDE

Attachment 2 includes brief instructions for use of high-pressure lifting bags.

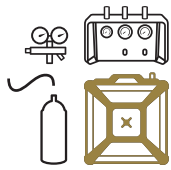

STEP  
1

### PROCEDURE

Prepare the Sava lifting bag, air source, controller, supply and connecting hoses where required.

### WARNING

At the time of lifting/lowering loads and during the preparation for the procedure, only qualified persons may be present at the site. Other persons should keep away from the site of lifting. Check the chosen Sava lifting bag for technical suitability.

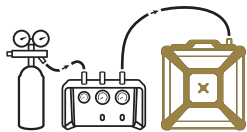

STEP  
2

### PROCEDURE

Connect all the components.

### WARNING

Pay attention to the pressure class of components. The 8 bar (116 psi), 10 bar (145 psi), 12 bar (174 psi) and 15 bar (218 psi) systems are not compatible. In the case of an air source with more than 12 bar (174 psi) of pressure, the use of a pressure reducing valve is mandatory.



STEP  
3

### PROCEDURE

Insert the chosen Sava lifting bag under the load.

### WARNING

Do not exceed the maximum number of lifting bags stacked on top of each other: with Sava lifting bags of SLK, SLK-L, SLK-H, Vega and Nova types, a maximum of two is allowed, and with Sava FLAT lifting bags of SFB-K, SFB-H and Vega Flat types, a maximum of three. Always secure the stacked Sava FLAT lifting bags types SFB-K and SFB-H with connecting straps.

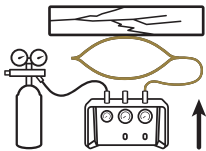

STEP  
4

### PROCEDURE

Lifting the load.

### WARNING

Use control levers or valves on the controller and the associated pressure gauges for controlling the lifting/lowering procedure. Never exceed the maximum inflation pressure. Never inflate the Sava lifting bags without a load to more than 1 bar (14.5 psi). Interrupt lifting upon reaching the required lifting height or the maximum inflation pressure.



STEP  
5

### PROCEDURE

Place safety supports under the load.

### WARNING

Never work under the load that is not secured with mechanical safety supports.

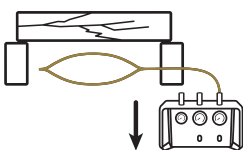

STEP  
6

### PROCEDURE

When the work is finished, deflate the Sava lifting bag completely.

### WARNING

Keep the Sava lifting bags connected to the controller during deflation. Always use discharge levers on the controller for deflating the Sava lifting bag.



STEP  
7

### PROCEDURE

Remove the Sava lifting bag from the place of use, disconnect air supply and connecting hoses, weigh them down to squeeze the remaining air out, clean and check them.



**Non-compliance with the instructions can result in various injuries. Carefully read the instructions for operation before using the lifting bag.**



#### **PERSONAL PROTECTIVE EQUIPMENT:**

Always wear personal protective equipment when working with Sava lifting bags. Fire fighters and rescue team members shall wear a complete protective gear specified for their work. Other users shall wear protective helmet, protective goggles and gloves, as well as protective footwear.



#### **TEMPERATURE RANGE OF USE:**

Lifting bags should be used within the temperature range from  $-20^{\circ}\text{C}$  ( $-4^{\circ}\text{F}$ ) to  $+80^{\circ}\text{C}$  ( $176^{\circ}\text{F}$ ). The product may be used at lower temperatures down to  $-40^{\circ}\text{C}$  ( $-40^{\circ}\text{F}$ ) for a maximum of 1 hour.



#### **CHOOSING THE RIGHT SAVA LIFTING BAG:**

When choosing the right Sava lifting bag, refer to the technical data tables, the lifting characteristics and the labels on the lifting bags.



The standard version of Sava lifting bags is NOT intended for use in potentially explosive atmospheres.

## ATTACHMENT 3: MEDIA RESISTANCE TABLE

Attachment 3 contains the Media Resistance Table.

### 1.1. MEDIA RESISTANCE TABLE



The Media resistance table has been produced in accordance with ISO/TR 7620.

The table below summarises the most commonly used media in connection with high-pressure lifting bags. If the medium you are using is not listed in the table, please refer to ISO/TR 7620 or consult the manufacturer about the use of high-pressure lifting bag.

In the table, the effect of the medium on the product is indicated as in the figure below and serves as a guide for the selection of a high-pressure lifting bag considering the type of rubber from which it is manufactured.

|                     |              |                 |               |
|---------------------|--------------|-----------------|---------------|
| <b>1 NEGLIGIBLE</b> | <b>2 LOW</b> | <b>3 MEDIUM</b> | <b>4 HIGH</b> |
|---------------------|--------------|-----------------|---------------|

Figure 1: Effect of the medium on the rubber

Table 1:

| MEDIA                   | CONCENTRATION [%] | TEMPERATURE [°C] | RUBBER TYPE |
|-------------------------|-------------------|------------------|-------------|
|                         |                   |                  | NR/BR       |
| Acetone                 |                   | 23               | 1           |
| Acetylene               |                   |                  | 1           |
| Ammonium hydroxide      | 10                | 23               | 1           |
|                         | Conc.             | 23               | 1           |
| Aniline                 |                   | 23               | 2           |
|                         |                   | 100              | 4           |
| Benzene                 |                   | 23               | 4           |
| Boric acid              | 10                | 100              | 1           |
| Brake fluid (vegetable) |                   | 50               | 1           |
| Butanol                 |                   | 50               | 1           |
|                         |                   | 100              | 4           |
| Butyric acid            |                   |                  |             |
| Calcium hydroxide       |                   | 100              | 1           |
| Calcium hypochlorite    | 15                |                  | 4           |
| Hydrochloric acid       | 20                | 23               |             |
| Ethanol                 |                   | 50               | 1           |
| Ether                   |                   | 23               | 4           |



| MEDIA                 | CONCENTRATION [%] | TEMPERATURE [°C] | RUBBER TYPE |
|-----------------------|-------------------|------------------|-------------|
|                       |                   |                  | NR/BR       |
| Formaldehyde          | 40                | 23               | 1           |
|                       | 40                | 70               |             |
| Glycerol              |                   | 100              | 1           |
| Hexanol               |                   | 23               | 1           |
| Formaldehyde          | 30                | 23               | 1           |
|                       | 90                |                  | 4           |
| Kerosene              |                   | 70               | 4           |
| Methanol              |                   | 50               | 1           |
| Methyl chloride       |                   |                  | 4           |
| Milk                  |                   | 23               | 1           |
| Mineral oils No. 1    |                   | 100              | 4           |
| Mineral oils No. 2    |                   | 100              | 4           |
| Mineral oils No. 3    |                   | 100              | 4           |
| Petroleum             |                   | 23               | 4           |
| Natural gas           |                   |                  | 3           |
| Dilute nitric acid    | 10                | 50               | 2           |
| Ozone (conc. 50 pphm) |                   | 40               | 4           |
| Phenol                |                   | 100              | 4           |
| Phosphoric acid       | 60                | 50               | 2           |
| Propanol              |                   | 50               | 1           |
| Sodium hydroxide      | 10                | 100              | 1           |
|                       | 25                | 100              | 1           |
| Sodium hypochlorite   | 10                | 50               | 2           |
| Sulphur hexafluoride  |                   |                  |             |
| Sulphuric acid (VI)   | 10                | 100              | 1           |
|                       | 20                | 23               | 1           |
|                       | 25                | 100              | 1           |
|                       | 50                | 100              | 1           |
|                       | 60                | 100              | 3           |
|                       | 75                | 100              | 4           |
|                       | 96                | 23               | 4           |
| Toluene               |                   | 23               | 4           |

# ATTACHMENT 4 : TECHNICAL CHARACTERISTICS OF PRODUCTS

Attachment 4 includes technical data about high-pressure flat lifting bags VEGA Flat.

## 1.1. HIGH-PRESSURE FLAT LIFTING BAGS VEGA Flat

### Technical data table

Table 1: Technical data table for VEGA high-pressure lifting bags

| TYPE            | PART NUMBER | DIMENSIONS    |               |               | WEIGHT      | WORKING PRESSURE | AIR REQUIREMENT | MAX. LIFTING CAPACITY | MAX. LIFTING HEIGHT | MAX. LIFTING CAPACITY AT MAX. LIFTING HEIGHT |
|-----------------|-------------|---------------|---------------|---------------|-------------|------------------|-----------------|-----------------------|---------------------|--|
|                 |             | LENGTH        | WIDTH         | HEIGHT        |             |                  |                 |                       |                     |  |
|                 |             | [cm] / [inch] | [cm] / [inch] | [cm] / [inch] |             |                  |                 |                       |                     |  |
| VEGA Flat 5/17  | 616671      | 48 / 18.9"    | 48 / 18.9"    | 2.5 / 1"      | 6.6 / 14.6  | 12 / 174         | 236 / 8.33      | 24.7 / 27.2           | 17 / 6.7"           | 5.0 / 5.5                                    |
| VEGA Flat 10/17 | 616672      | 55 / 21.6"    | 55 / 21.6"    | 2.5 / 1"      | 8.6 / 19.0  | 12 / 174         | 365 / 12.89     | 33.2 / 36.5           | 17 / 6.7"           | 10.0 / 11.0                                  |
| VEGA Flat 20/17 | 616673      | 67 / 26.4"    | 67 / 26.4"    | 2.5 / 1"      | 12.3 / 27.1 | 12 / 174         | 897 / 31.68     | 50.2 / 55.2           | 17 / 6.7"           | 20.0 / 22.0                                  |
| VEGA Flat 40/17 | 616674      | 84 / 33"      | 84 / 33"      | 2.7 / 1.1"    | 21.1 / 46.5 | 12 / 174         | 1381 / 48.77    | 80.2 / 88.2           | 17 / 6.7"           | 40.0 / 44.0                                  |
| VEGA Flat 55/17 | 616675      | 93 / 36.5"    | 93 / 36.5"    | 2.7 / 1.1"    | 27.5 / 60.6 | 12 / 174         | 1895 / 66.92    | 100.2 / 110.2         | 17 / 6.7"           | 55.0 / 60.5                                  |

### Lifting characteristics

Graph 1: Lifting characteristics of high-pressure flat lifting bags VEGA Flat

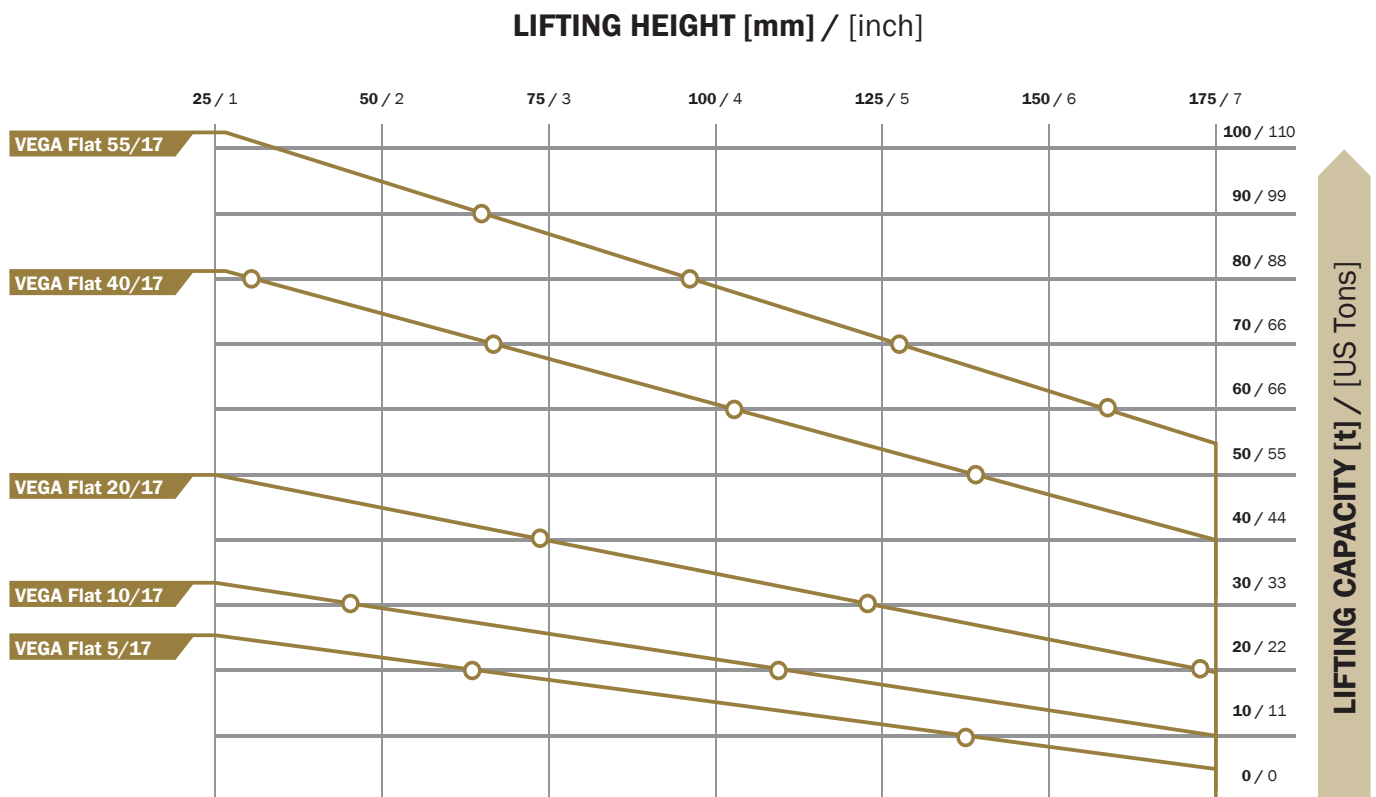

## ATTACHMENT 5: LIST OF ACCESSORIES

---

Attachment 5 includes a list of accessories to be used with high-pressure lifting bags.



Use high-pressure lifting bags with the original accessories available from the manufacturer.

Table 1: List of accessories

| CODE   | NAME                                 |
|--------|--------------------------------------|
| 609798 | Controller 2 EXP 12                  |
| 609802 | Controller 3 EXP 12                  |
| 609799 | Controller 2 EXP 15                  |
| 609803 | Controller 3 EXP 15                  |
| 613218 | EXP controller case                  |
| 616092 | EXP lamp                             |
| 609794 | Pressure reducing valve 300-12 bar   |
| 609795 | Pressure reducing valve 300-15 bar   |
| 611200 | Hose for pressure reducing valve     |
| 611187 | Inflation hose, 12 bar, 5 m, red     |
| 611188 | Inflation hose, 12 bar, 10 m, red    |
| 611183 | Inflation hose, 12 bar, 5 m, yellow  |
| 611184 | Inflation hose, 12 bar, 10 m, yellow |
| 611185 | Inflation hose, 12 bar, 5 m, blue    |
| 611186 | Inflation hose, 12 bar, 10 m, blue   |
| 611189 | Inflation hose, 12 bar, 5 m, grey    |
| 611190 | Inflation hose, 12 bar, 10 m, grey   |
| 611195 | Inflation hose, 15 bar, 5 m, red     |
| 611197 | Inflation hose, 15 bar, 10 m, red    |
| 611191 | Inflation hose, 15 bar, 5 m, yellow  |
| 611192 | Inflation hose, 15 bar, 10 m, yellow |
| 611193 | Inflation hose, 15 bar, 5 m, blue    |
| 611194 | Inflation hose, 15 bar, 10 m, blue   |
| 611198 | Inflation hose, 15 bar, 5 m, grey    |
| 611199 | Inflation hose, 15 bar, 10 m, grey   |

Trelleborg is a world leader in engineered polymer solutions that seal, damp and protect critical applications in demanding environments. Its innovative solutions accelerate performance for customers in a sustainable way.

Trelleborg Industrial Solutions is a leading supplier of polymer-based critical solutions in selected industrial application areas and infrastructure projects.

**ISO 9001**  
**ISO 14001**  
**ISO 45001**



**Trelleborg Slovenija d.o.o.**  
PG Environmental protection products



Škofjeloška cesta 6, 4000 Kranj, Slovenija

phone: +386 (0)4 206 6388  
e-mail: [tis.kra.info.eko@trelleborg.com](mailto:tis.kra.info.eko@trelleborg.com)  
fax: +386 (0)4 206 6390



[www.trelleborgslovenija.com](http://www.trelleborgslovenija.com)  
[trelleborg.com/seals-and-profiles](http://trelleborg.com/seals-and-profiles)

