



Discover our Product Range



AR **Interactive catalog**
Simply install the augmented reality app on your smartphone to be amazed.



**Accelerate
your business**

now



Latest Innovations

Innovation is one of Trelleborg's core values and we aim to proactively apply innovative thinking in everything we do.

By doing so, we can continuously pioneer developments that create competitive advantage. Our ambition is to think differently, in a new and creative manner on a daily basis with a focus on innovations that not only encompass products and functions but also process, applications and service.

At Trelleborg Sealing Solutions, our innovation activities concentrate on creating solutions and applications in close cooperation with and to meet the changing needs of our customers. Solutions for Tomorrow's Engineering demonstrate the innovation of Trelleborg Sealing Solutions in action!

Contents

4	ServicePLUS	85	Hydraulic Wear Rings
6	Tools & Resources	87	Static Seals
16	Films & Animations	93	O-Rings
18	Markets & Technologies	97	Rotary Seals
48	Solutions & Capabilities Brands & Materials	107	Bearings & Bushings
51	Engineered Seals, Gaskets and Other Parts	109	Pneumatic Seals
59	Hydraulic Seals – Piston Seals	113	Non-standard Pneumatic Seals
67	Hydraulic Seals – Rod Seals	115	Surface Finishing
75	Hydraulic Scrapers	119	Index

EXPERIENCE AUGMENTED REALITY



To fully experience this augmented reality brochure, scan the QR code to download the app from the App Store or Google Play, or download directly by searching for "Trelleborg Sealing Solutions Augmented Reality Library".

- 1** Install and start the app on your device.
- 2** Select Product Range AR.
- 3** Use your device to scan the AR symbol wherever you find it in the brochure to see films, animations and other interactive features.



ServicePLUS

THE PLUS FOR YOUR BUSINESS

When you partner with Trelleborg Sealing Solutions through our ServicePLUS program, you can focus on your core business while we focus on ensuring all of your value chain needs are covered. We concentrate on business activities, which typically offer the largest resource saving opportunities.

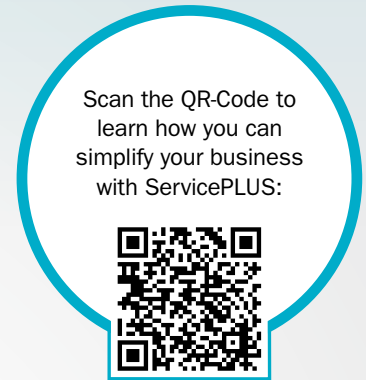

TECHNICAL COLLABORATION

Apply Trelleborg's expertise to your business. Whether starting a new development or enhancing existing products, access our experts in materials and design for sealing solutions with optimal application performance. Take advantage of digital tools, sealing technology training and customized seminars to support your technical and commercial teams.



SURFACE TECHNOLOGIES

Surface quality matters as much as the seals you use. Improve friction characteristics and eliminate sticking with surface modifications, such as Seal-Glide® to reduce costs in automated assembly and improve application performance. Ensure parts are as clean as they should be for sensitive applications and strict regulations with FlexClean™.



TAILORED PRODUCTION SERVICES

Enhance your manufacturing with tailored production services. State-of-the-art 3D printing and rapid prototyping help bring products to the market faster. Strengthen your core business processes by outsourcing subcomponent assembly and secondary operations to Trelleborg Sealing Solutions.



TESTING & QUALITY ASSURANCE

Trelleborg Sealing Solutions is set up to run a full suite of material and product tests to improve efficiency and help reduce your inspection expenses. Fully automated inspection cells and quality clinics can verify performance and accordance with standards, with full documentation produced.



PACKAGING SOLUTIONS

Our packaging and labeling solutions aim to support your business and boost your aftermarket care. They are customized to meet your specific needs, including custom tubing for direct insertion into automated feeding stations, bespoke machine-readable labeling for replacement part sets and aftermarket kits directly drop-shipped to your service centers or customers.



ADVANCED DELIVERY & STOCK MANAGEMENT SERVICES

Simplify, streamline and enhance your supply chain with our delivery and stock management services. Let Trelleborg Sealing Solutions manage your important C-parts or benefit from automated ordering services that optimize your replenishment processes and align with production flows.



Tools & Resources

	Website Tools & Services 	Mobile Apps  	Technical Library
 <p>Mechanical Design Assistance</p>	 Aerospace Groove Selector  Hydraulic System Calculator  Area & Volume Calculator  O-Ring Calculator	 Aerospace Groove Selector  Hydraulic System Calculator  Area & Volume Calculator  Fluid Mechanics Calculator  Mechanical Engineering Calculator	 Technical Articles
 <p>Standards / Conversions / Norms For table: Non Austenitic steel (Rockwell B Hardness Range)</p>	 ISO Fits & Tolerances  Unit & Hardness Converter  Hardness Converter	 ISO Fits & Tolerances  Unit & Hardness Converter  Fluid Mechanics Calculator	
 <p>Learning / Knowledge</p>	 e-Learning on Sealing Technology	 Installation Instructions  Technical Glossary  Fluid Mechanics Calculator  AR Literature App  In the Groove	 Whitepapers  Webinars  Technical Articles
 <p>CAD / Drawings</p>	 CAD Services	 CAD Models	
 <p>Material Selection</p>	 Chemical Compatibility Check  Material Search  Healthcare Materials  Tube & Hose Selector	 ISO Fits & Tolerances  Sealing Materials Selector	 Webinars
 <p>Product Selection</p>	 Aerospace Groove Selector  Electronic Catalog  O-Ring Calculator  Sealing Solutions Configurator  Technical Proposals Online  Rotary Seal Selector	 O-Ring Selector  Shim Selector  Tube & Hose Selector  Rotary Seal Selector  Product Range App  Seals Catalog App	 Webinars  Technical Articles

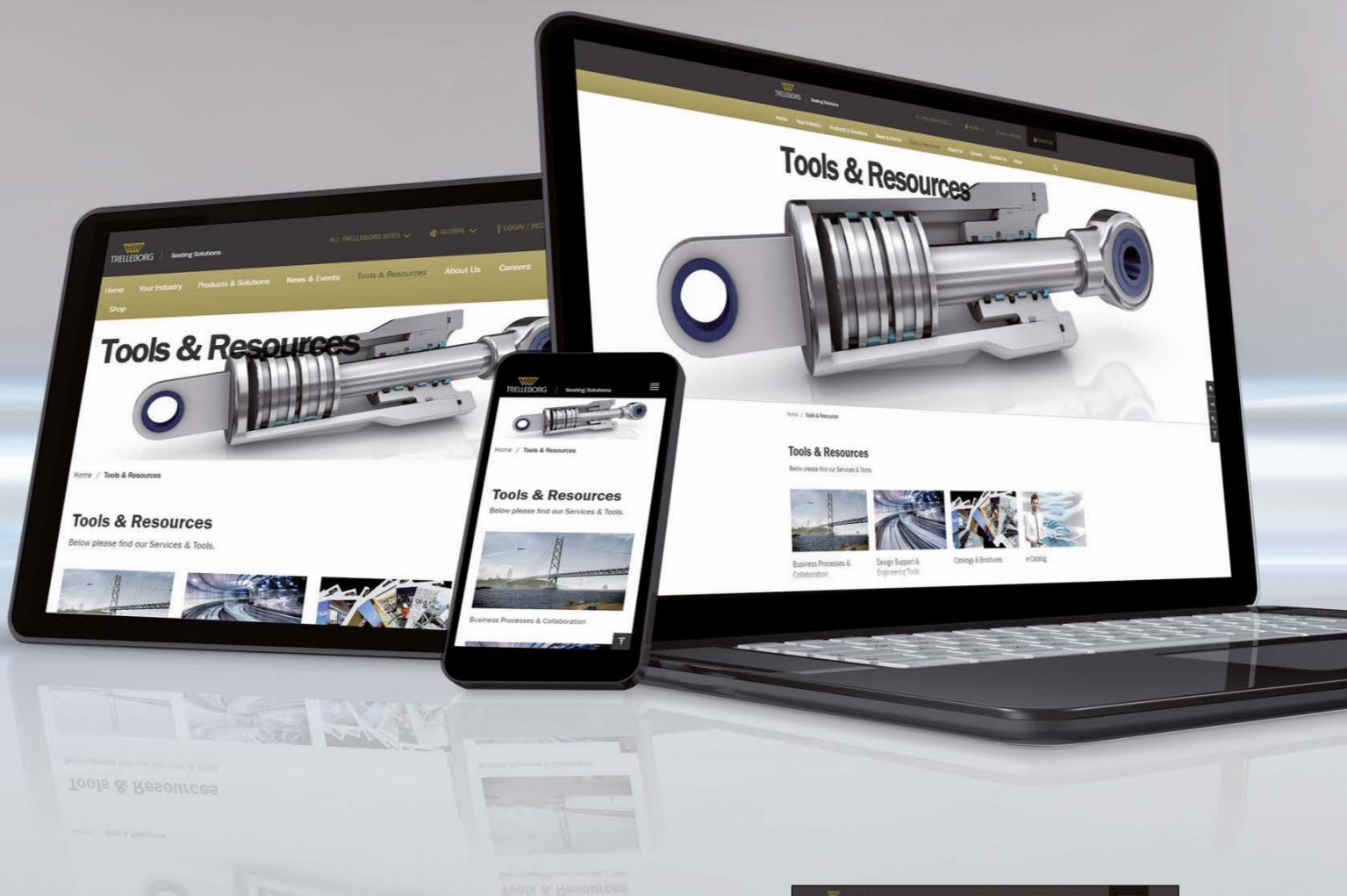
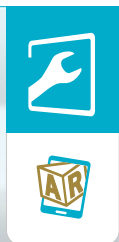

TOOLS & RESOURCES ONLINE



Trelleborg Sealing Solutions offers a wide range of tools & resources that support engineers and purchasers in their daily business. For more information, scan the QR-Code or visit our website: www.trelleborg.com/seals



Aerospace Groove Selector



The Aerospace Groove Selector helps to find the sizes of grooves and hardware and indicates if the groove is suitable for a dynamic and/or a static seal. It also provides an instant conversion between inch and mm sizes.

AR Literature App



Unlock interactive content in printed media from Trelleborg Sealing Solutions with the Augmented Reality Literature App.

Learn more about our innovative products and solutions by interacting with augmented reality components in diverse printed media. Download the app and scan pages with AR Icons to get access to interactive animations, videos and technical information.

Area & Volume Calculator



This mobile app makes it quick and easy to calculate the area and volume of predefined geometrical shapes.

The formula used to calculate the area or volume is displayed and parameters can be entered in a range of metric and imperial units.

CAD Models



This app allows users to view, rotate and zoom to examine Trelleborg Sealing Solutions products in 3-D, as well as send CAD files to any email address, wherever you may be.

CAD Service



The CAD Service offers easy access to download technical drawings in 2-D and 3-D and in any file format available, ready to import directly into your CAD software.

Chemical Compatibility Check



Which material is best suited to your application?

The easy-to-use Chemical Compatibility Check allows you to quickly find out which materials are compatible with the media used in your application.

Fluid Mechanics Calculator



This app covers a wide variety of fluid mechanics topics and serves as a reference for the analysis, design, maintenance and operation of fluid related systems.

It quickly provides results for different fluid mechanics equations, including those used in civil, structural, pipe flow and engineering. The app is relevant for students, engineers, analysts and researchers working in the fields of automotive, aerospace, biotechnology, fluid power, marine, mining and oil & gas.

e-Learning on Sealing Technology



These comprehensive e-Learning lessons teach the basics of sealing technology, available to you 24 hours a day.

Electronic Catalog



The Electronic Catalog offers a high-powered, convenient search tool: you can search for seals by item number, type of seal or by operating conditions.

Additionally, once you know the product you require, you can then request a quotation online. A simple-to-use service lets you load up a shopping cart and send it through to your local Customer Solution Center for quotation.

Hardness Converter



The Hardness Converter lets you easily convert between popular scales used to measure the hardness for metallic materials.

You can switch between DIN EN ISO18265:2003 and ASTM E-140-07 standards.

Healthcare Materials



This app for the healthcare and medical industry offers a quick and easy overview of which materials are compatible with different environments.

Hydraulic System Calculator



Hydraulic System Calculator helps you design a solution around the cylinder which may involve motor, pump, orifice and pipe calculations. The application is in compliance with ISO 3320, ISO 3321 & ISO 4393.

in the groove magazine



View all issues of Trelleborg Sealing Solutions *in the groove* magazine that provides the latest news, products and services from the world of seals.

Available as a print edition, an interactive pdf and a tablet app.

Installation Instructions



Installation instructions usually feature a series of written steps with diagrams, which aren't always clear or easy to follow.

Included in the app are videos, guides and transcripts, making installation easier, quicker and more accurate than ever.

ISO Fits & Tolerances



An intuitive tool to quickly look-up ISO Fits & Tolerances. Upon entering the nominal diameter needed, simply select the tolerance classes for bore and shaft.

The app then provides the complete ISO fits definition with all relevant values including the type of fit. Tolerances are shown for the most commonly used ISO tolerance classes.

Material Search



Need information on a particular material? The convenient Material Search Tool allows you to search our materials in two ways:

Material name - Search our various elastomer compounds by material name, group or selected properties.

Product type - Quickly find our preferred standard materials for O-Rings, Quad-Rings and V-Rings.

Mechanical Engineering Calculator



An excellent tool offers over 244 formulas in 16 categories, with more being added every update.

Categories include mathematics, physics and mechanical engineering. To perform calculations, just choose a formula and enter the required variables. The app will then calculate and display the result.

O-Ring Calculator



The O-Ring calculator offers engineers and professionals a quick and easy way to calculate O-Ring dimensions and the appropriate housing layout in accordance with the international O-Ring standard ISO 3601.

O-Ring Selector



When a user enters installation specifications into the O-Ring Selector app such as the bore or rod/shaft diameter, the app quickly calculates O-Ring and housing dimensions in both metric and inch.

In addition, the app recommends O-Ring sizes according to ISO 3601, so you know exactly which part you need.

Product Range App



The product range shows the entire portfolio of standard products and gives information on capabilities for custom solutions in an interactive experience.

Rotary Seal Selector



There are many factors in rotary applications, such as lubrication conditions, cooling and hardware surface, which have an impact on the seal type and material.

The Rotary Seal Selector app was developed with this in mind and is designed specifically to help you select the best rotary seal for your application.

Sealing Materials Selector



The Sealing Materials Selector allows you to easily search Trelleborg Sealing Solutions materials. By simply entering material specifications, for example, the material group, in combination with your required parameters, the app instantly proposes the right materials for your requirements.

In addition, you can filter down your search based on chemical compatibilities, institute approvals or product type for O-Rings, Quad-Rings and V-Rings.

Seals Catalog App



This easy-to-use app lets you select seals, load up your shopping cart and send it through to your local Customer Solution Center for quotation. You are guaranteed a rapid response, making the whole process of specifying and ordering seals easier and quicker than ever!

Sealing Solutions Configurator



Need help finding out which seals work best in your application? Try out the Sealing Solutions Configurator!

This Sealing Solutions Configurator provides you with the most suitable solutions for your application. Just select the industry and application then enter the operating parameters to get recommended sealing solutions.

Shim Selector



The Shim Selector is designed to give brake NVH test engineers quick and easy access to the extensive range of shim materials used for elimination of specific brake noise problems.

With only a few parameter inputs, such as temperature and frequency, the Shim Selector will propose the optimal solution for the given noise problem.

Technical Articles



A collection of technical articles on a range of engineering and industry topics. Experts share their insights on the latest advances in sealing technology and engineered products.

Technical Proposals Online



Technical Proposals Online (TPO) is a tool designed to enhance the cooperation between our Trelleborg Sealing Solutions engineers and you, our customer. This is what the TPO offers you:

- A proposed sealing solution for your application, complete with application and product images
- A full range of technical data regarding products, materials and installation information
- A central storage and management portal for all your technical proposals

Technical Glossary



This app provides definitions of more than 2,000 terms from the world of sealing technology and engineering.

Not just about seals, the app aims to provide a comprehensive resource for all your engineering needs, to make life a little easier.

Tube & Hose Selector



Specifically developed for the healthcare and medical industry, the Tubing and Hose Selector app simplifies choosing the correct tubing and hose based on input parameters such as material and pressure, giving the information instantly and removing the need to search through catalogs.

Unit & Hardness Converter



By simply selecting the dimension and entering the value for conversion, the app offers a wide range of engineering and scientific units for each dimension.

Webinars



Our webinars provide an educational resource on topics relevant to sealing technology and engineered products and applications.

They cover practical, targeted topics taught by experts in their field.

Whitepapers



Trelleborg Sealing Solutions experts provide an in-depth look at new developments related to sealing technology and engineered products.

TOOLS & RESOURCES ONLINE

Trelleborg Sealing Solutions offers a wide range of tools & resources that support engineers and purchasers in their daily business.



For more information, scan the QR-Code or visit our website:
www.trelleborg.com/seals

Design Support & Engineering Tools

ONLINE TOOLS MAKE LIFE EASIER

Trelleborg Sealing Solutions has developed a number of online tools that make the working life of an engineer specifying seals easier. All these industry-leading tools are available free-of-charge from the Trelleborg Sealing Solutions website at www.trelleborg.com/seals. To use these advanced services all you have to do is register on the Members Area.

There is also a continually increasing range of innovative engineering apps available for smartphones, both for iOS and Android devices. Just search for "Trelleborg" in the App Store or GooglePlay to find the tools to optimize your daily productivity.

Materials Search and Chemical Compatibility Check

These two programs allow you to find out the compatibility of sealing materials with hundreds of different media and help identify the most suitable material for your application.

- + Very good suitability
- Good suitability
- Limited suitability
- ✗ Unsuitable
- ? Insufficient information

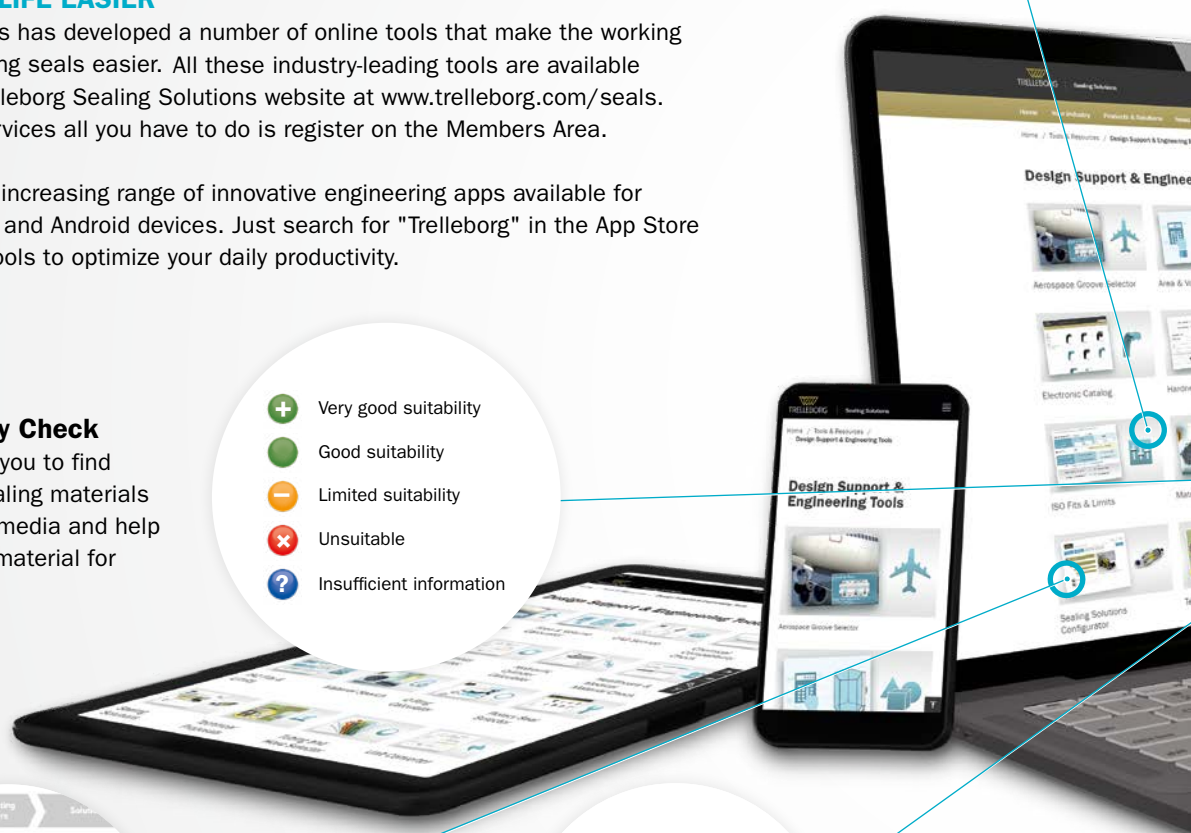

Sealing Solutions Configurator

The Sealing Solutions Configurator is the first tool of its kind offered by any seal supplier. It allows engineers to identify a proven sealing solution for their specific application in just four easy steps.

4.0 Proposal Introduction

Dear Hilde Heens
Thank you for your call. We have had a look sealing solution to your application.

7.1.3 TSS Item No. and installation dimensions

1. Turcite® / Zurcon® GR6901000-T47

Slydring®
Rod Diameter dN=100.0
Groove Diameter D2=105.0
Groove Width LZ=9.7

Kote® Slydring®
Rod Diameter dN=100.0
Groove Diameter D2=105.0
Groove Width LZ=9.7

Technical Proposals Online

Enhance your communication with Trelleborg Sealing Solutions with the Technical Proposals Online tool. Instantly access all your proposed solutions anywhere at any time and benefit from quicker dialog with our sealing specialists.

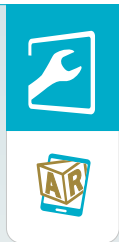

ISO Fits & Tolerances

Our Fits & Tolerances Calculator allows you to easily determine type of fits using the tolerances according to DIN ISO 286. In addition, upon entering the nominal diameter the tool calculates lower and upper limit deviations plus the maximum and minimum interferences dependent on the selected tolerance classes for bore and shaft.



Versatile CAD Service

The CAD download functionality provides thousands of drawings of a wide range of seals. It gives the option of 2- or 3-dimensional files in a range of formats to suit most commonly used CAD systems.



Hydraulic System Calculator

Hydraulic System Calculator helps you design a solution around the cylinder which may involve motor, pump, orifice and pipe calculations. The application is in compliance with ISO 3320, ISO 3321 & ISO 4393.



Rotary Seal Selector

The Rotary Seal Selector allows you to search through the wide range of rotary seals and materials available based on application conditions and offers detailed information on installation and seal capabilities.

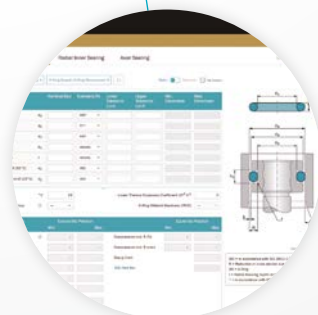

O-Ring Calculator

An industry-leading tool, the easy to use O-Ring calculator includes sizing capabilities, compression forces, design parameter recommendations and complete measurements. Results and comments may be printed, shared or filed as PDF.

Discover our design support and engineering tools at www.trelleborg.com/seals



Mobile Tools & Apps

We understand the needs of engineers on the go. Check out our latest mobile tools and apps, ranging from an O-Ring calculator to unit and hardness converters. Just search for "Trelleborg" in the App Store or Google Play to find the tools to optimize your daily productivity.

Discover our wide range of mobile tools and apps at www.trelleborg.com/seals



MANY MORE APPS available

Available on the APP STORE



Android App on Google Play

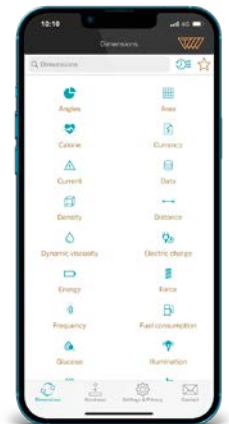
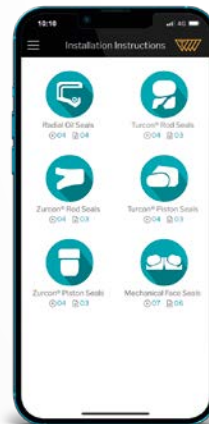
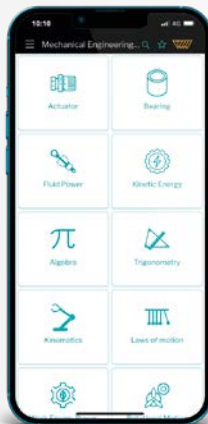

ISO Fits & Tolerances

Simply enter the nominal diameter and select the tolerance classes for bore and shaft to find the complete ISO fits definition. It contains all relevant values, including type of fit, with handy graphs to illustrate the classes by bore and shaft. The results of this application are based on DIN ISO 286.



Mechanical Engineering Calculator

A useful app containing over 250 formula calculators in 16 categories, with more being added with every update. Categories include the fields of mathematics, physics and mechanical engineering.



Aerospace Groove Selector

This app covers five of the most important SAE Aerospace groove standards, making it quick and easy to find the size of grooves and hardware needed. Includes dimensions for AS4716 Rev B, AS4716 Rev A, AS6235 Rev A, AS4088 Rev E and AS4832 Rev A.



Installation Instructions

Videos demonstrate the best practice methods for installing seals, providing all relevant documentation within the interface. It guides you to successful installation of Radial Oil Seals, Mechanical Face Seals and Turcon® and Zurcon® rod and piston seals.



Converter - Universal

By simply selecting the dimension and entering a value for conversion, the app offers a wide range of engineering and scientific units for each dimension. It also has other useful features like currency conversion, timezone conversion, percentage calculations, a running pace calculator and more.

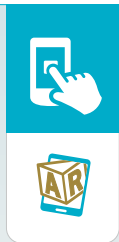

in the groove

Our *in the groove* magazine provides news, technical and product information on seals, as well as insights into the markets they are used in. The magazine is also available in print and as an interactive PDF.



Rotary Seal Selector

This app is specifically for the selection of rotary seals based on application information, including size, operating parameters and the lubricant used. It also considers installation type and seal function.



O-Ring Selector

When a user enters installation specifications into the O-Ring Selector app, such as the bore or rod/shaft diameter, the app quickly calculates O-Ring and housing dimensions in both metric and inch. Standards covered are ISO 3601-1, NFT 47-502, JIS B 2401 and SMS 1586.

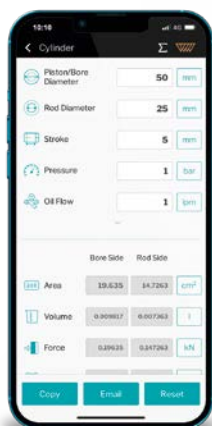

Hydraulic System Calculator

The Hydraulic System Calculator helps you design a solution around the cylinder, which may involve motor, pump, orifice and pipe calculations. The application is in compliance with ISO 3320, ISO 3321 and ISO 4393.

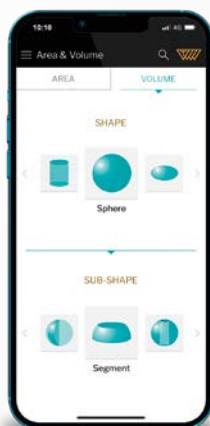

Area and Volume Calculator

Speeds up and simplifies calculating the area and volume of more than 170 geometric shapes. The app supports both metric and inch, and conveniently displays the formulas used. Fill your shape with solids or liquids, choosing from 1500 different materials to calculate the weight.

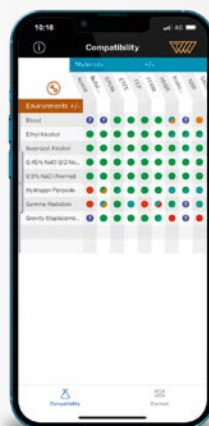

Healthcare Materials

A quick and easy overview of the compatibility of 34 materials with 35 chemical environments that are commonly encountered in the healthcare and medical industries. Select up to 20 materials and environments at once to produce a chart that rates each material from 'excellent' to 'not recommended'.

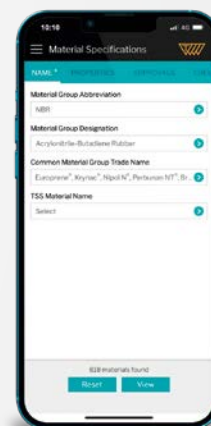

Sealing Materials Selector

Enter material specifications and required parameters, such as application temperature or hardness, to receive instant material proposals. The app features filters to limit searches based on chemical compatibility, institute approvals and product type. Data sheets can be requested from within the interface.

Electronic Catalog

Discover the Electronic Catalog online as an app or on our website



The Electronic Catalog is a user-friendly service that connects you to the broad range of products Trelleborg Sealing Solutions offers. The products are arranged based on product type and product group, making it easy to find the exact one you need.

Many functions are also included within the Electronic Catalog that allow you to understand product capabilities, compare similar seals, request a quote and much more. The Electronic Catalog is available from the Trelleborg Sealing Solutions website and in the App Store and GooglePlay for mobile use.

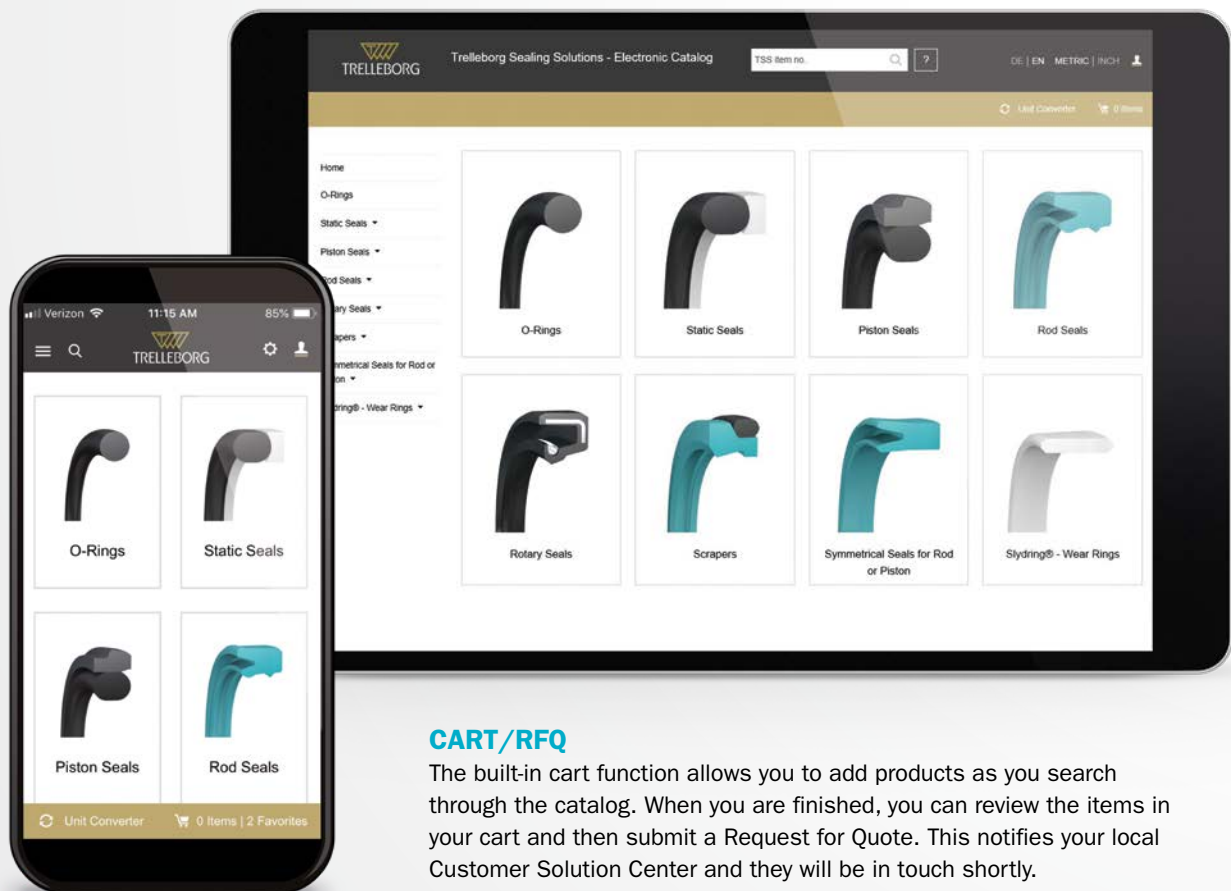

CART/RFQ

The built-in cart function allows you to add products as you search through the catalog. When you are finished, you can review the items in your cart and then submit a Request for Quote. This notifies your local Customer Solution Center and they will be in touch shortly.

FILTERING

If you have specific operating conditions that the seal must meet and/or installation dimensions, the Electronic Catalog offers a filtering function within the product groups. Here you can input your temperatures, pressure, speed and various installation dimensions to filter products that can meet your needs.

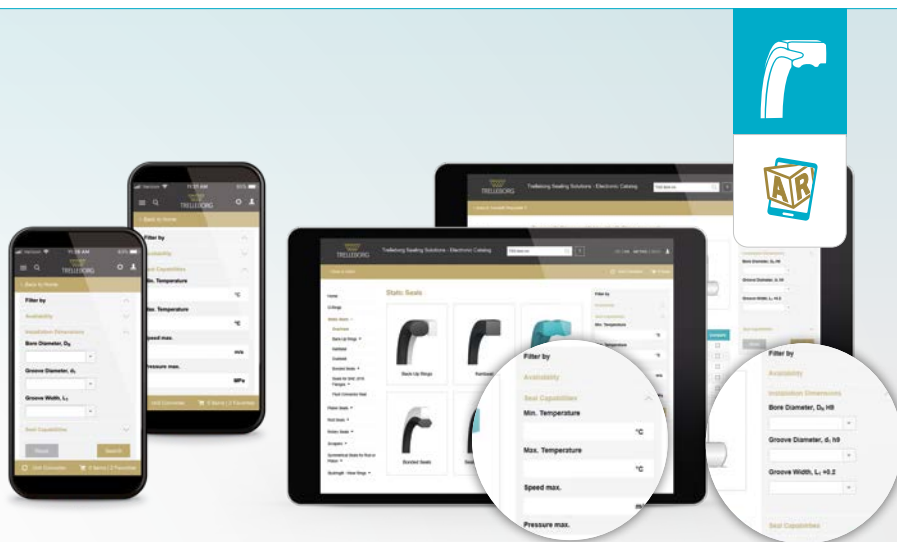

PRODUCT COMPARISON

When looking through the catalog, you can choose to compare multiple products. The product comparison function allows you to select which products you are interested in, and then puts all relevant information into a table for your review. You can even choose to display all product details side by side or to only show the fields where they differ.

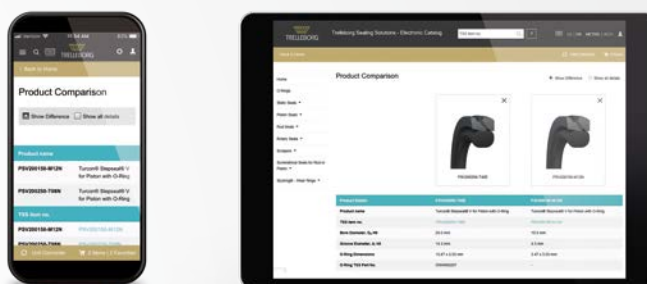

PRODUCT INFORMATION

Detailed product information is available for each part number. Once you select a specific part number, you will be able to see its installation dimensions, seal capabilities, related catalogs and other information. From this page, registered users can access the material data sheets that are applicable to the part number.

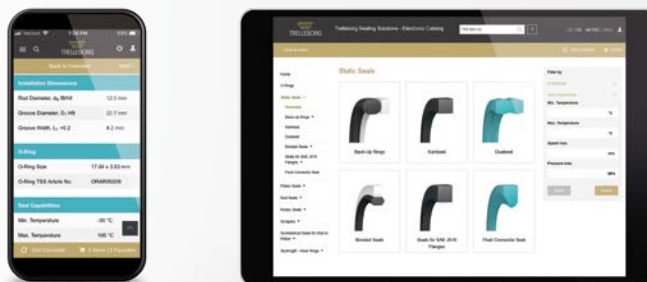

ADD TO FAVORITES

Do you have a part that you frequently look up or need information on? You can now save any of our part numbers as a favorite that is linked to your account. Anytime you log in to the Electronic Catalog, your favorites will be a click away!

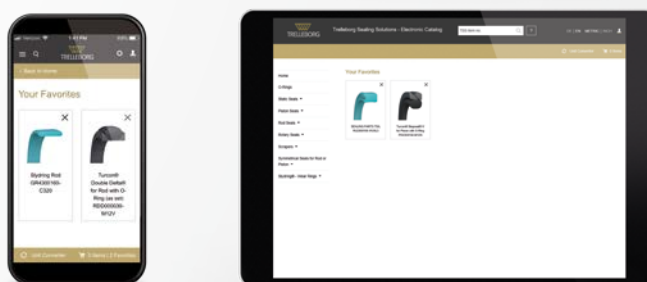

UNIT CONVERTER

If you are looking at a product and need to know the conversion between metric and imperial, you can use the Unit Converter tool that is available at the top of the screen for web users and at the bottom for mobile.

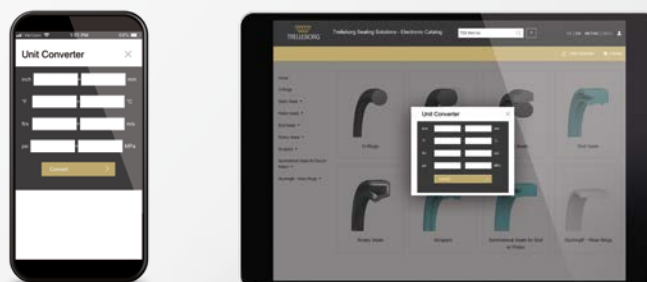

Films & Animations

SEEING IS BELIEVING

Complex sealing configurations can feature a large number of sealing elements. Trying to illustrate these on a 2-D page is difficult and can never properly show their function or characteristics. Trelleborg Sealing Solutions uses the latest graphic technologies to produce 3-D animations of applications and typical sealing solutions for them.

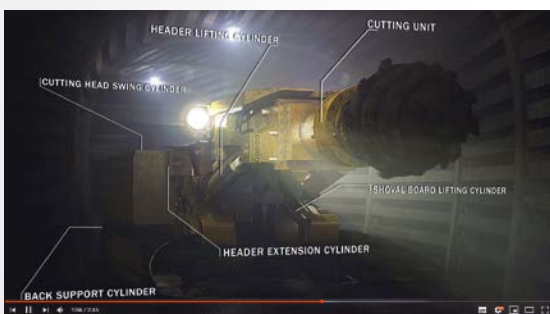

View at
[YouTube.com/
trelleborgseals](https://www.youtube.com/trelleborgseals)
You
Tube

View at
[www.trelleborg.com/
seals/films](http://www.trelleborg.com/seals/films)



Films and Animations online

A range of films specific to different industries and products are available to view on the Trelleborg Sealing Solutions website or via YouTube.



Markets & Technologies



Aerospace



Agriculture



Automotive, Truck & Transportation



Chemical Transport & Process Industries



Construction & Mining Equipment



Electrification



Energy & Hydrogen



Fluid Power



Food & Beverage



Healthcare & Medical



Industrial Automation



Manufacturing & Machine Tools



Marine Equipment & Construction



Material Handling

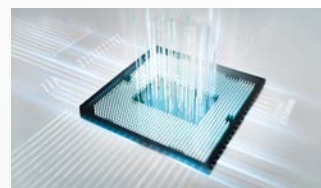

Semiconductor



Water



Accelerating performance in your industry
Scan the QR-Code or visit our website to find out more about our tailor-made solutions for your industry.
www.trelleborg.com/seals

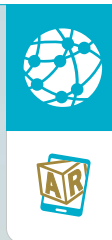

Aerospace

Trelleborg Sealing Solutions is the world's leading supplier of sealing solutions to the aerospace industry with a history that goes back over 60 years.

For further literature, films and digital tools, please scan the QR-Code:

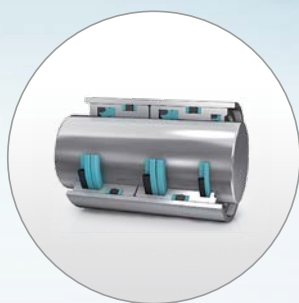

Hydraulics & Actuation

- Market leading sealing solutions for Primary Flight Controls and Landing Gear
- Weight saving and seal friendly bearings for Landing Gear



Engine Seals

- Extensive knowledge of Fire Seal development
- In-house Fire Seal Test Rig
- Huge product portfolio for engine applications
- Expanding portfolio of high performance plastics



Aerodynamic Seals

- Many years experience in the development and manufacture of wing seals

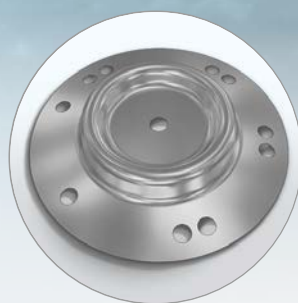

Aircraft Cabin Interior Sealing

- Aeroflex "bulp" and "blade" type seals
- Orkot and HiMod® bearings and bushings
- Cabin air conditioning diaphragms
- Fluid, water and waste sealing system
- O-Rings (with FDA approval)

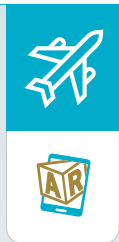

APPLICATION HIGHLIGHT: ENGINE AND PYLON SEALS

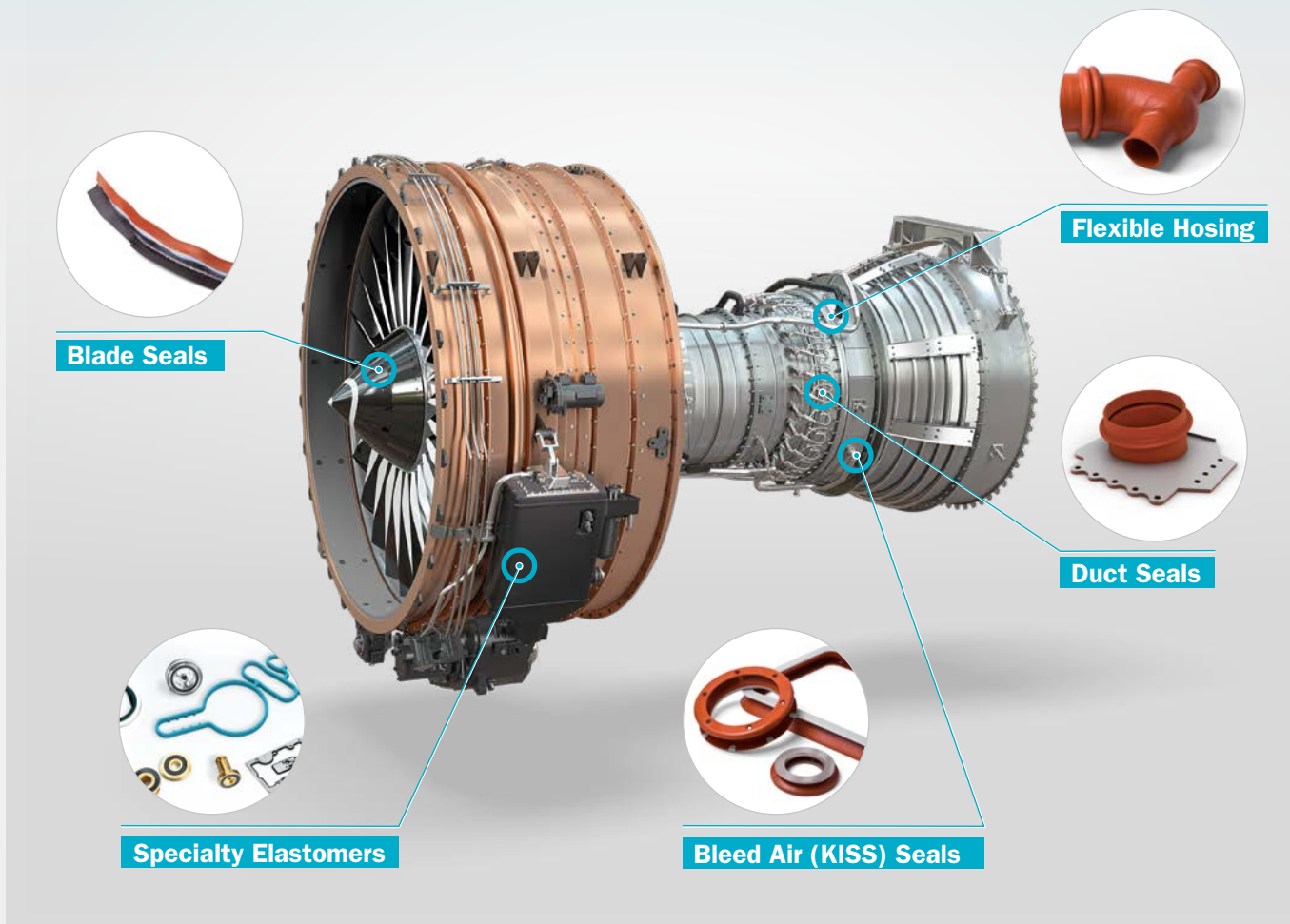

AEROSPACE AFTERMARKET SERVICES

- Enhanced Services**
Efficiency through delivery of higher level assemblies
- Logistics**
Customized supply chain solutions
- Handling**
Enhanced safety and performance through custom pre-packed kits
- Hands-on Support**
Trouble shooting and technical support globally 24/7
- Engineering**
Engineering solutions based on more than 60 years of experience

AEROSPACE GROOVE SELECTOR APP



This app covers five of the most important SAE Aerospace groove standards for hydraulic systems, AS4716 Rev B, AS5857 Rev A, AS6235 Rev A, AS4088 Rev E and AS4832 Rev A. You can easily find groove sizes and determine if grooves are suitable for a dynamic and/or static seal. Available in Metric and Inch, based on standard Dash numbers. For more information scan the QR-Code or visit our website www.trelleborg.com/seals

Agriculture

Trelleborg Sealing Solutions is a long-standing expert in the off-highway industry, supplying complex sealing configurations primarily for the hydraulics of tractors and other farming equipment.



Linear Seals

- Wide range of rod and piston seals
- Turcon® Stepseal® 2K
- Zurcon® Rimseal
- Turcon® Stepseal® V
- Zurcon® RU9
- Turcon® Glyd Ring® T
- Zurcon® Glyd Ring® D
- Zurcon® Scraper DA24



Rotary Seals

- Standardized oil seals
- Pressure rotary seals in various materials for standardized glands
- Turcon® Roto L®
- Turcon® Roto Glyd Ring® S



Guiding Elements and Static Seals

- Orkot®
- HiMod®
- Turcite®



Materials

- Wide range of static seals in Elastomer, TPU, PTFE and Steel grades
- FKM iXLT V8T71
- Turcon® M12
- Zurcon® Z13, Z25
- Orkot® C480

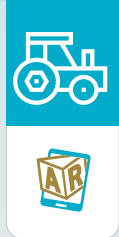

APPLICATION HIGHLIGHT: CASSETTE SEAL

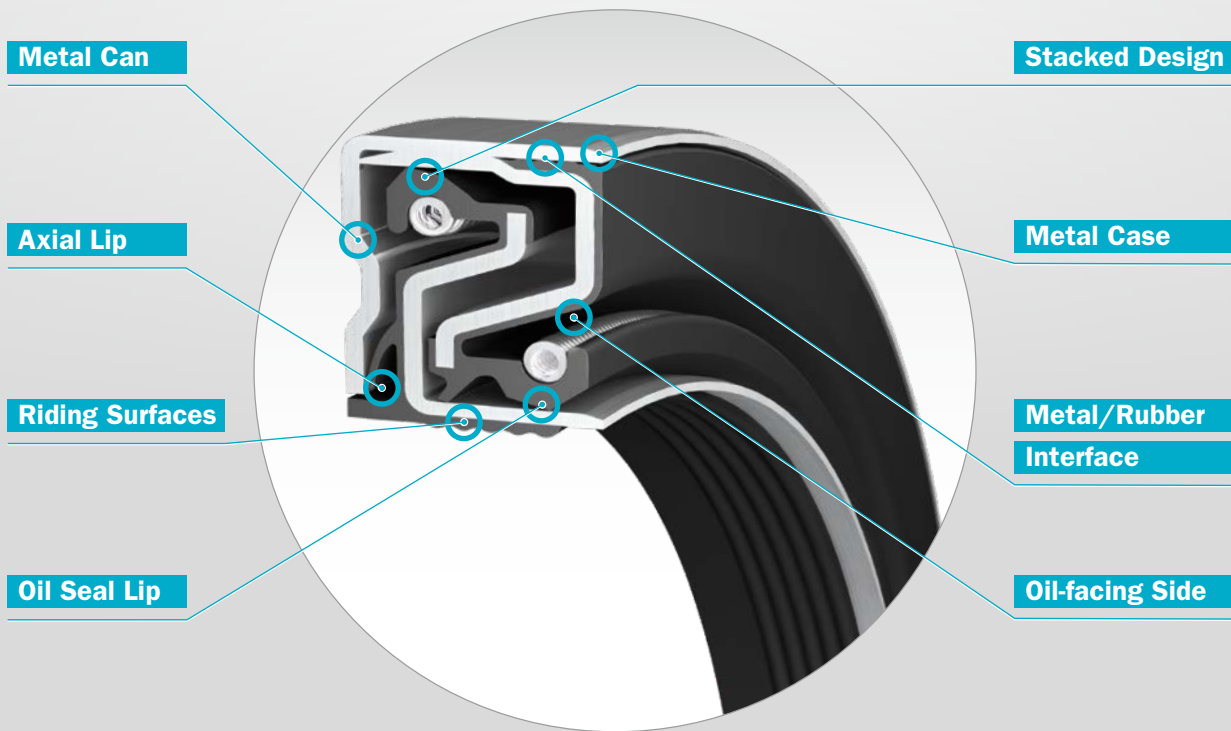

MOBILE HYDRAULICS SEALING SYSTEMS FILM



Sealing Solutions for Off-Highway Equipment. Learn more about sealing in off-highway vehicles in our film by scanning the QR-Code or visit our website: www.trelleborg.com/seals

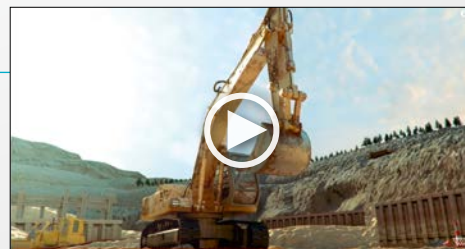

Automotive, Truck & Transportation

Trelleborg Sealing Solutions is a leading supplier of advanced sealing solutions to automotive Original Equipment Manufacturers (OEMs) and their component suppliers.

For further literature, films and digital tools, please scan the QR-Code:



HiSpin® PDR RT & HiSpin® HS40

- Capable of rotary speeds over 40 m/s
- Low power consumption
- Dry operation or lubricated to suit any application
- Conductive PTFE material available
- Quick prototypes to meet dynamic eMobility market requirements



Molded Seals & Gaskets

- Complex shapes
- Advanced design capabilities
- Temperature and chemical resistant materials
- Exceptional production quality



Rubore® Cap Seals

- Cost and time savings
- No more adhesives needed in production
- Provides for reduced assembly cost
- Higher safety in low pressure applications
- Tested and released in series
- Highly corrosion resistant



LSR Components

- World class, highly automated LSR production capabilities
- Cleanrooms
- State-of-the-art automation equipment



APPLICATION HIGHLIGHT: E-AXLE SEALING



HiSpin® PDR RT



Rubore® Flat Seal



HiSpin® HS40

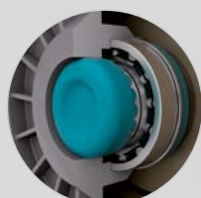

Rubore®
Cap Seal

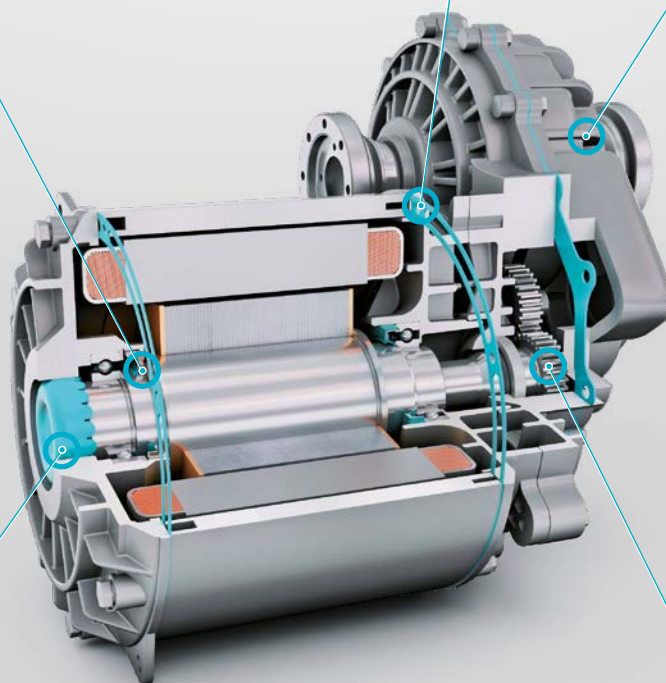

Rubore®
Radial Damper

HiSpin® FILM



Want to find out more about automotive solutions?
Then check out the Trelleborg Sealing Solutions HiSpin®
movie by scanning the QR-Code or visit our website:
www.trelleborg.com/seals



Construction & Mining Equipment

Trelleborg Sealing Solutions is a long-standing expert in the off-highway industry, supplying complex sealing configurations primarily for the hydraulics of a wide variety of construction equipment.

For further literature, films and digital tools, please scan the QR-Code:



Linear Seals

- Wide range of rod and piston seals
- Turcon® Stepseal® 2K
- Zurcon® Rimseal
- Zurcon® RU9
- Turcon® Glyd Ring® T
- Zurcon® Glyd Ring® D
- Zurcon® Scraper DA24
- Zurcon® Buffer Seal
- Turcon® Stepseal® V



Rotary Seals

- Standardized oil seals
- Pressure rotary seals in various materials for standardized glands
- Turcon® Roto L®
- Turcon® Roto Glyd Ring® S



Guiding Elements and Static Seals

- Orkot®
- HiMod®
- Turcite®



Materials

- Wide range of static seals in Elastomer, TPU, PTFE and Steel grades
- FKM iXLT V8T71
- Turcon® M12
- Zurcon® Z13, Z25
- Orkot® C480



APPLICATION HIGHLIGHT: HYDRAULIC CYLINDER

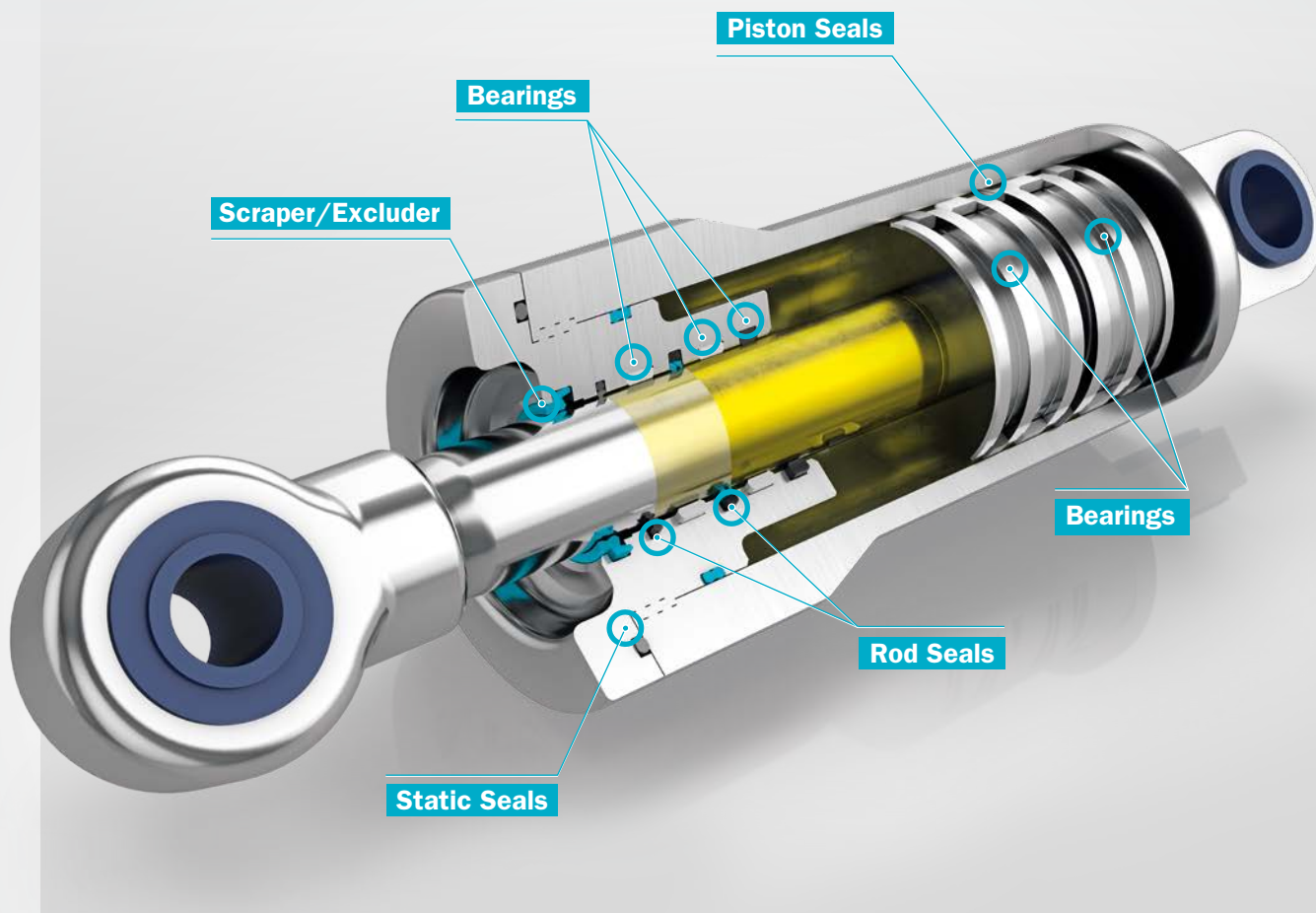

MOST COMMON APPLICATIONS

Excavators

- Work cylinders for excavators
- Piston of the hydraulic cylinder

Tractors and other agricultural equipment

- Hydraulic transmissions
- Hydraulic steering gear

Cranes

- Prehensile cylinder for loading cranes
- Rotary Union revolving joint

SEALING SOLUTIONS FOR MINING

Want to find out more about solutions for Construction & Mining Equipment? Then check out the Sealing Solutions for Mining film by scanning the QR-Code or visit our website: www.trelleborg.com/seals





Electrification

eMobility is booming, and it places high demands on components. When developing high-performance seals for eMobility applications, Trelleborg combines an effective R&D organization with modern digital processes to reduce lead times to the lowest possible for initial functional prototypes.

For further literature, films and digital tools, please scan the QR-Code:





APPLICATION HIGHLIGHT: EVOLVING ELECTRIC

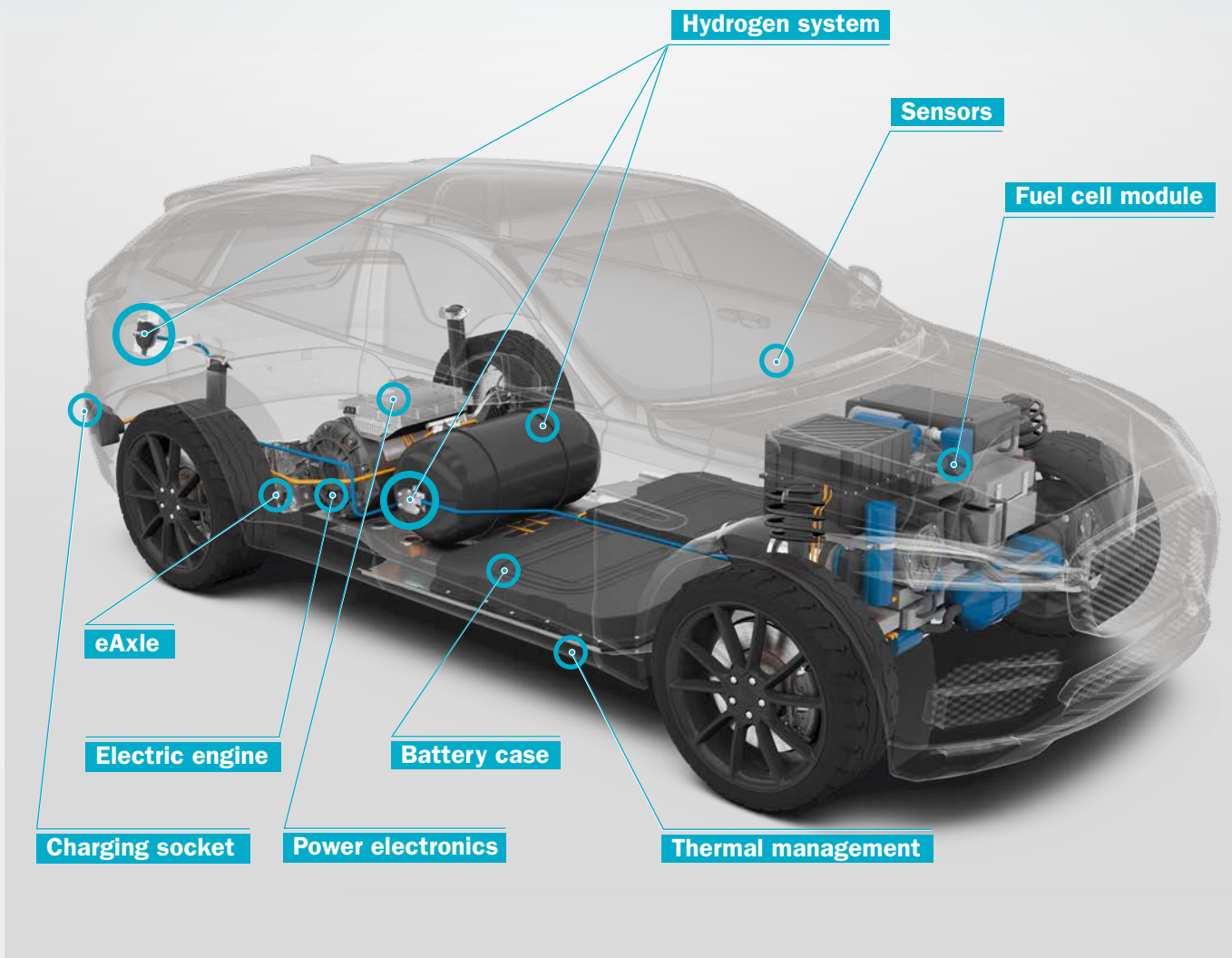

OUR SOLUTIONS

Trelleborg has developed sealing solutions for various methods of transportation. Our sealing experts partner with customers to design, manufacture and supply the optimum solution to meet application needs.

Aerospace

Seals for electric aircraft applications



Automotive

HiSpin for e-Axles



e-Bikes & Bicycles

Sealing solutions for e-bike and bicycle applications



Fuel Cell Electric Vehicles

Sealing solutions to meet the challenges of hydrogen powered mobility



Fluid Power

Hydraulic applications are challenging for seals. Not only must the hydraulic seals prevent leakage of fluid from the cylinder, but hydraulic seals must also withstand high pressures, extreme temperatures and transverse forces within the cylinder.

For further information on Fluid Power, scan the QR-Code:

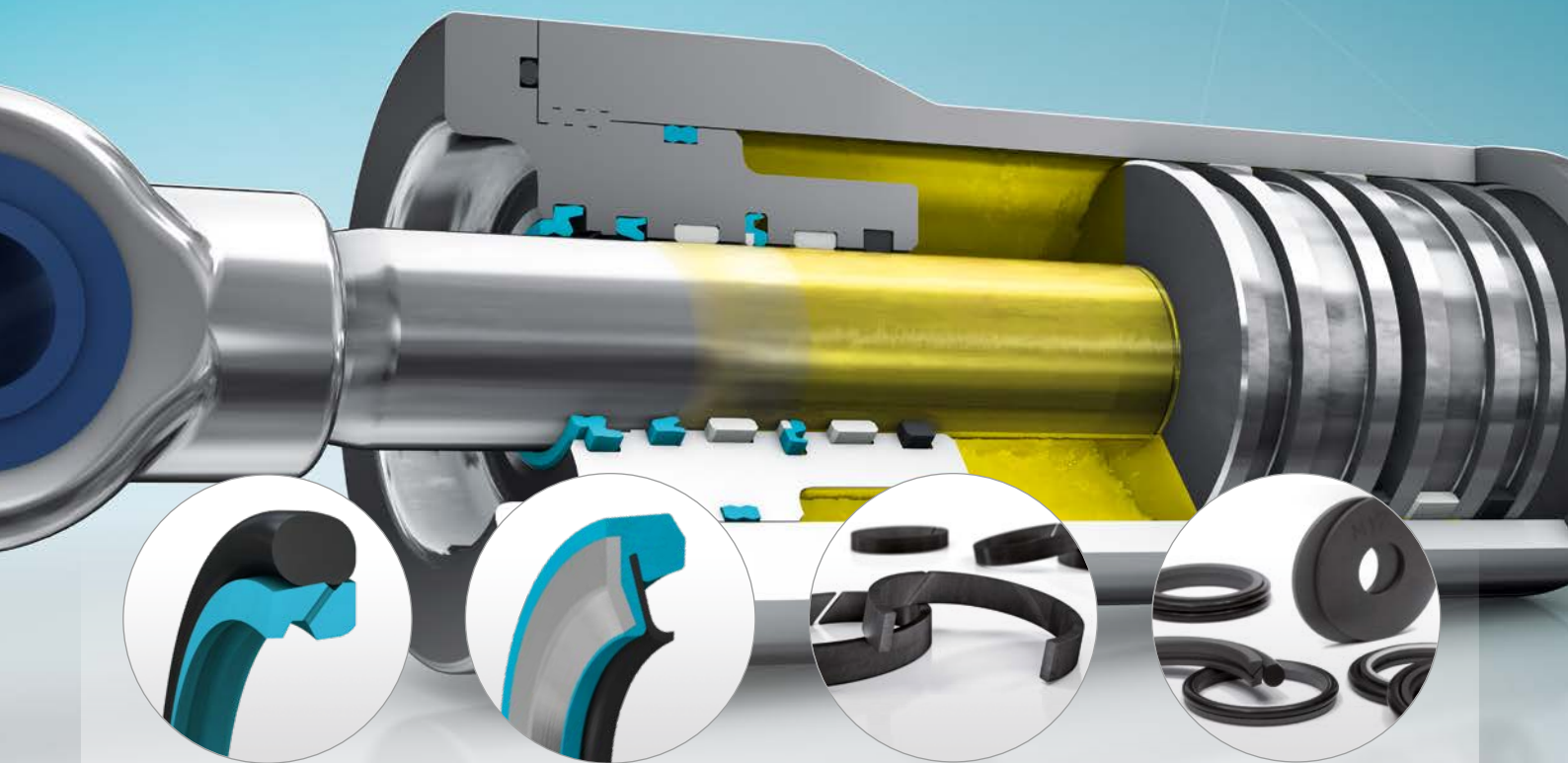

Linear Seals

- Wide range of rod and piston seals
- Turcon® Stepseal® 2K
- Turcon® Stepseal® V
- Turcon® Glyd Ring® T
- Zurcon® Buffer Seal
- Zurcon® Glyd Ring® D
- Zurcon® Scraper DA24

Rotary Seals

- Standardized oil seals
- Pressure rotary seals in various materials for standardized glands
- Turcon® Roto L®
- Turcon® Roto Glyd Ring® S
- Turcon® Roto Glyd Ring® V

Guiding Elements and Static Seals

- Orkot®
- HiMod®
- Turcite®

Materials

- Wide range of static seals in Elastomer, TPU, PTFE and Steel grades
- FKM iXLT V8T71
- Turcon® M12
- Zurcon® Z13 and Zurcon® Z25
- Orkot® C480

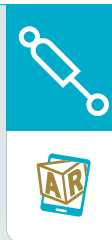

APPLICATION HIGHLIGHT: HYDRAULIC CYLINDER

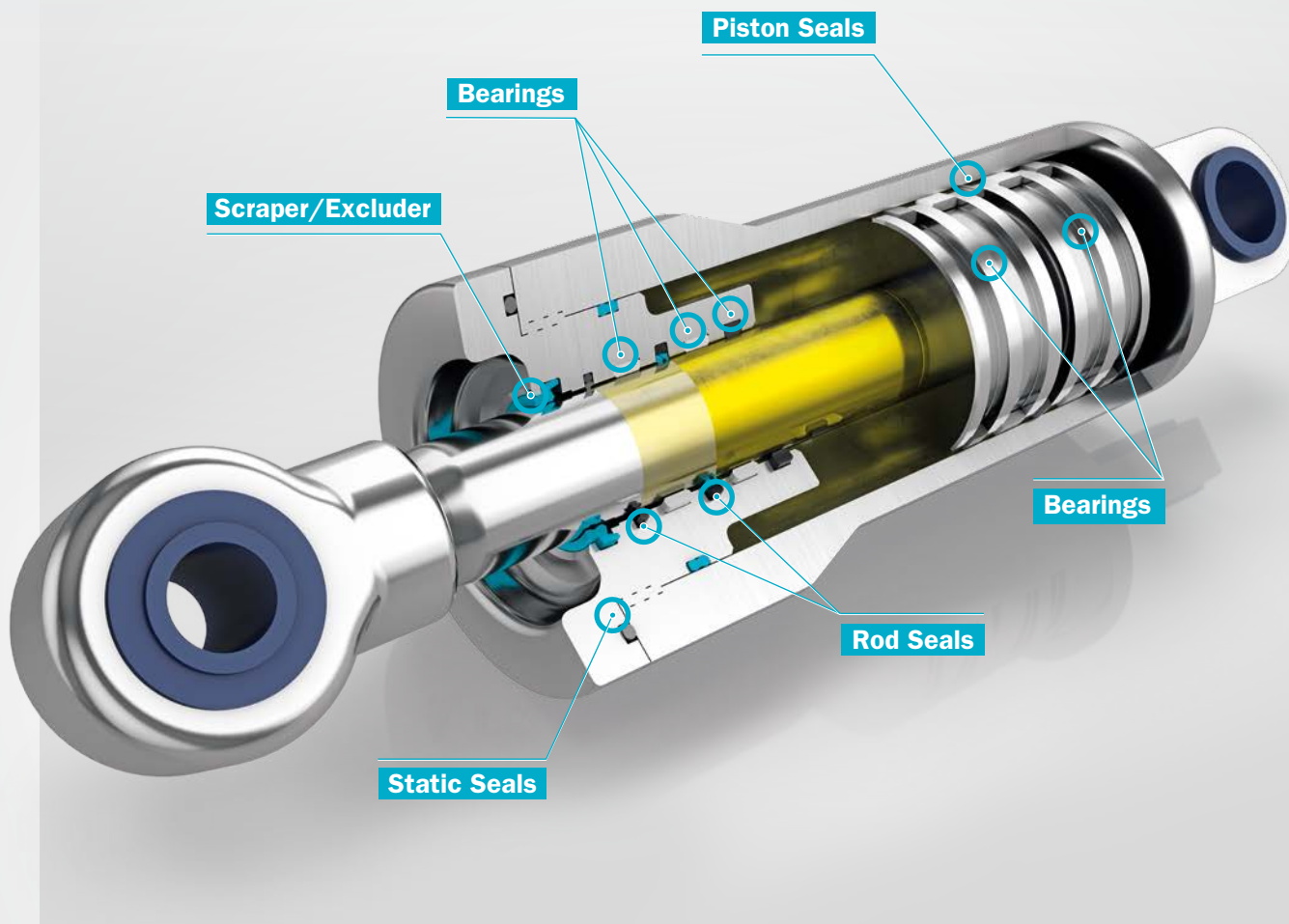

MOST COMMON APPLICATIONS

Excavators	Concrete pumps
Construction site vehicles	Hauling plants
Construction industry	Railroads
Agricultural machines	Mining
Tractors and other agricultural equipment	Cranes

SEALING SOLUTIONS FOR FLUID POWER COMPONENTS

Want to find out more about solutions for Fluid Power components? Then check out the film by scanning the QR-Code or visit our website:
www.trelleborg.com/seals



Food & Beverage

Trelleborg Sealing Solutions has been involved in sealing food & beverage applications since the 1960s. Based on unrivalled experience, the company has developed an outstanding range of sealing materials and products, certified according to all global regulatory standards.

For further literature, films and digital tools, please scan the QR-Code:



O-Rings

- Versatile sealing element
- Cost-effective solution
- Minimize hardware and design costs
- Compact design
- Easy installation
- Materials specific for food and beverage applications



Molded Parts/ Liquid Silicone Rubber

- High product purity and cleanliness
- Custom-designed to application conditions
- Complex shapes, thin sections and parts with undercuts
- Flashless molding and fully automated production possible



Linear & Rotary Seals

- Linear seals for dynamic or static applications
- Stick-slip free operation
- Very low friction
- Very good thermal resistance
- High resistance to wear and aging
- Long service life
- Universal chemical compatibility



Bearings

- High load bearing capacity
- High wear resistance and long service life
- Very low friction
- Unique self-lubricating and composite materials available
- Universal chemical compatibility



APPLICATION HIGHLIGHT: FILLING EQUIPMENT

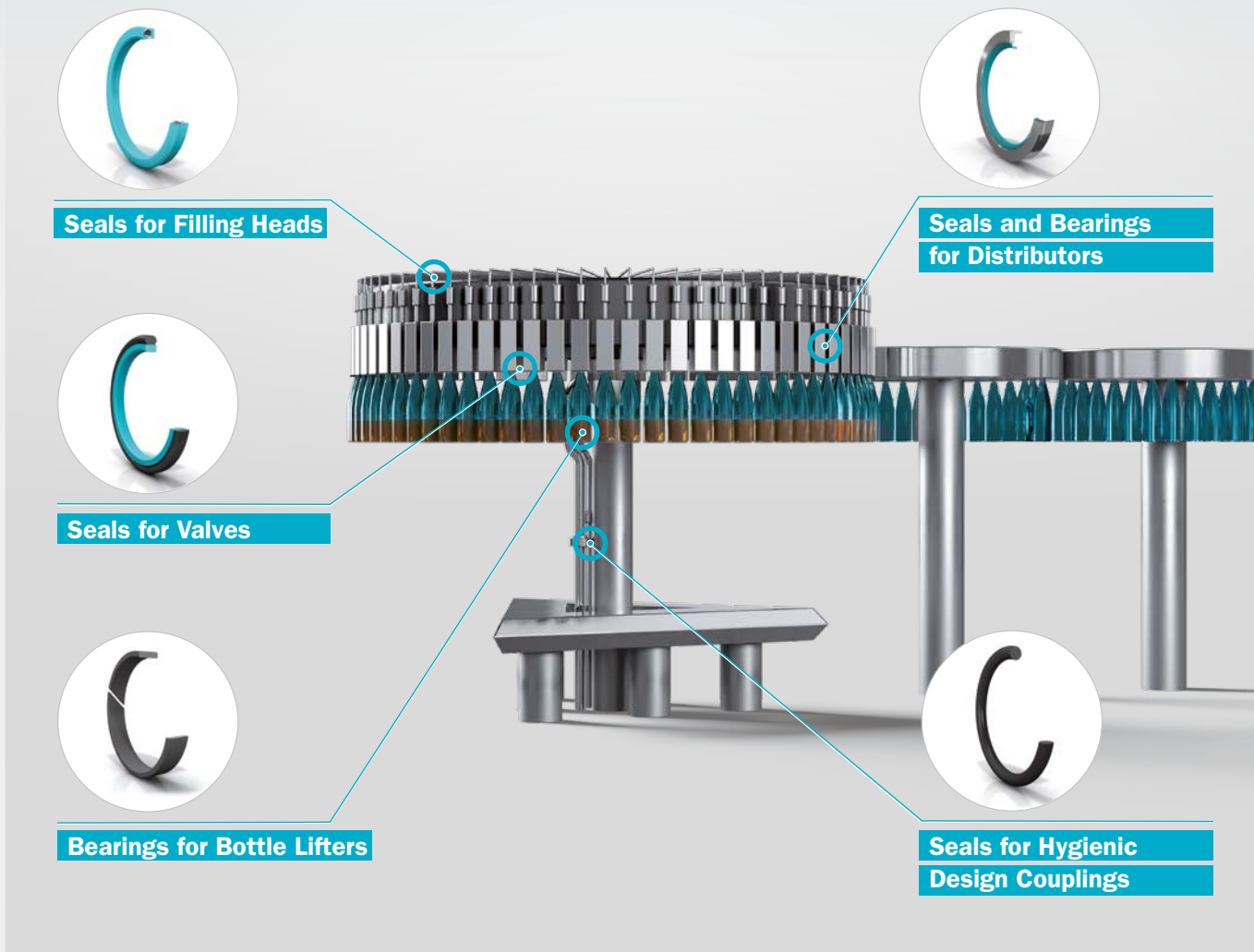

MOST COMMON APPLICATIONS

Preparation equipment	Compressors
Fill, form & seal equipment	Filling equipment
Valves	Pumps
Beverage dispensing	Processing & packaging equipment
Small appliances	

SEALING MATERIALS SELECTOR

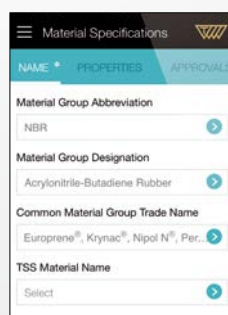

For information about the Sealing Materials Selector, scan the QR-Code or visit our website: www.trelleborg.com/seals



Healthcare & Medical

For further literature, films and digital tools, please scan the QR-Code:



Trelleborg Healthcare & Medical partners with customers to design, develop, manufacture and bring to market innovative engineered solutions for demanding medical device, biotech and pharmaceutical applications.



Liquid Silicone Rubber Components

- High precision shapes, thin sections, micro-size
- Ultra-clean parts
- Automated production
- High precision tool design and manufacture
- Wasteless and flashless manufacturing



Silicone Tubing

- Biocompatibility
- Full traceability
- High precision and tight tolerances
- Cleanroom manufacturing
- Even and reliable delivery of fluids



Rubber Molded Components

- Local support, design engineering, FEA
- Material development
- Product testing support
- High precision components



Static, Linear and Rotary Seals

- Large material selection
- Excellent fluid compatibility
- Wide temperature and pressure range
- No compression set issues



APPLICATION HIGHLIGHTS



LSR Coatings
LSR dip technology to achieve desired functionality



Anesthesia Device

Elastomer O-Rings
Standard and custom O-Rings for all of your needs

Custom 2K/2-shot Diaphragm
Improved quality and performance with lower total costs with 2 shot designs

Custom Elastomer Gaskets
Solutions designed for manufacturing that meet your functional requirements

Silicone Tubing and Mask
Standard and custom tubing, fit to desired lengths

Electrosurgical Instruments

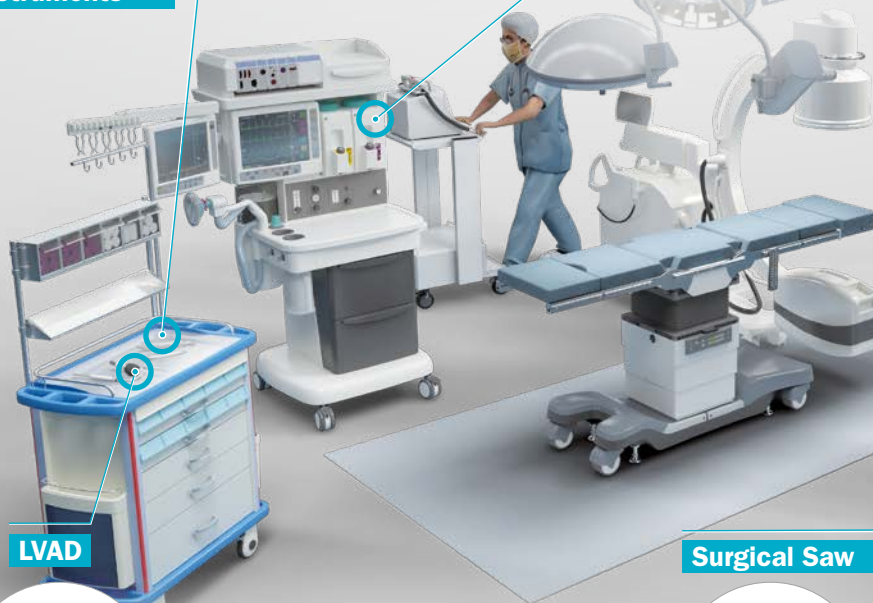

LVAD



Cannulas, O-Rings, silicone sleeves, jackets for cables, bend & strain relief components
Custom LSR parts for all types of long-term and short-term implants

Surgical Saw



Rotary Seal
Designed to extend seal life and improve performance

MOST COMMON APPLICATIONS

Blood & gas analyzers	Prosthetic knees
Anesthesia devices	MRI tables
Metered dose inhalers	Hemodialysis equipment
Combination products	Oxygen concentrators
Drug delivery pumps	

HEALTHCARE MATERIALS APP



For further information about the Healthcare Materials App & Web Tool, scan the QR-Code or visit our website: www.trelleborg.com/seals



Industrial Automation

Robotics components must support the unit in its daily operations, maintaining performance and reducing downtime. See some examples of how our products contribute to efficiency and reliability in robotics applications.

For further literature, films and digital tools, please scan the QR-Code:



Rotary Seals

- Design and materials optimized for robotic motion, offering low torque and low wear
- FDA-compliant material available
- Low friction and compression set
- Long service life



Pneumatic Seals

- Low stick-slip
- High speed performance
- Wide range of application temperatures
- Good resistance to ozone and weathering
- High resistance to wear



Hydraulic Seals

- Low friction, high efficiency
- Stick-slip free
- High abrasion resistance and operational reliability
- Wide range of application temperatures and good resistance to chemicals



Bearings & Bushings

- Low friction
- Molded to consolidate component parts
- Materials compatible with virtually all media, both system and cleaning
- Light-weight with good strength and stiffness
- Dry operation or lubricated to suit any robotic application



Engineered Molded Parts

- Size range: 20mm – 2400 x 900mm
- Thickness: 0.6mm – 10mm
- Compounds: HNBR, FKM, NBR, EPDM, CR, NR, VMQ, ACM & AEM
- Materials: Aluminium, Steel, Stainless steel, Engineered plastics
- Plating/Coating: Corrosion protective plating on steel available, as well as MaxWax® assembly wax treatment

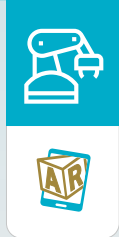

MOST COMMON APPLICATIONS

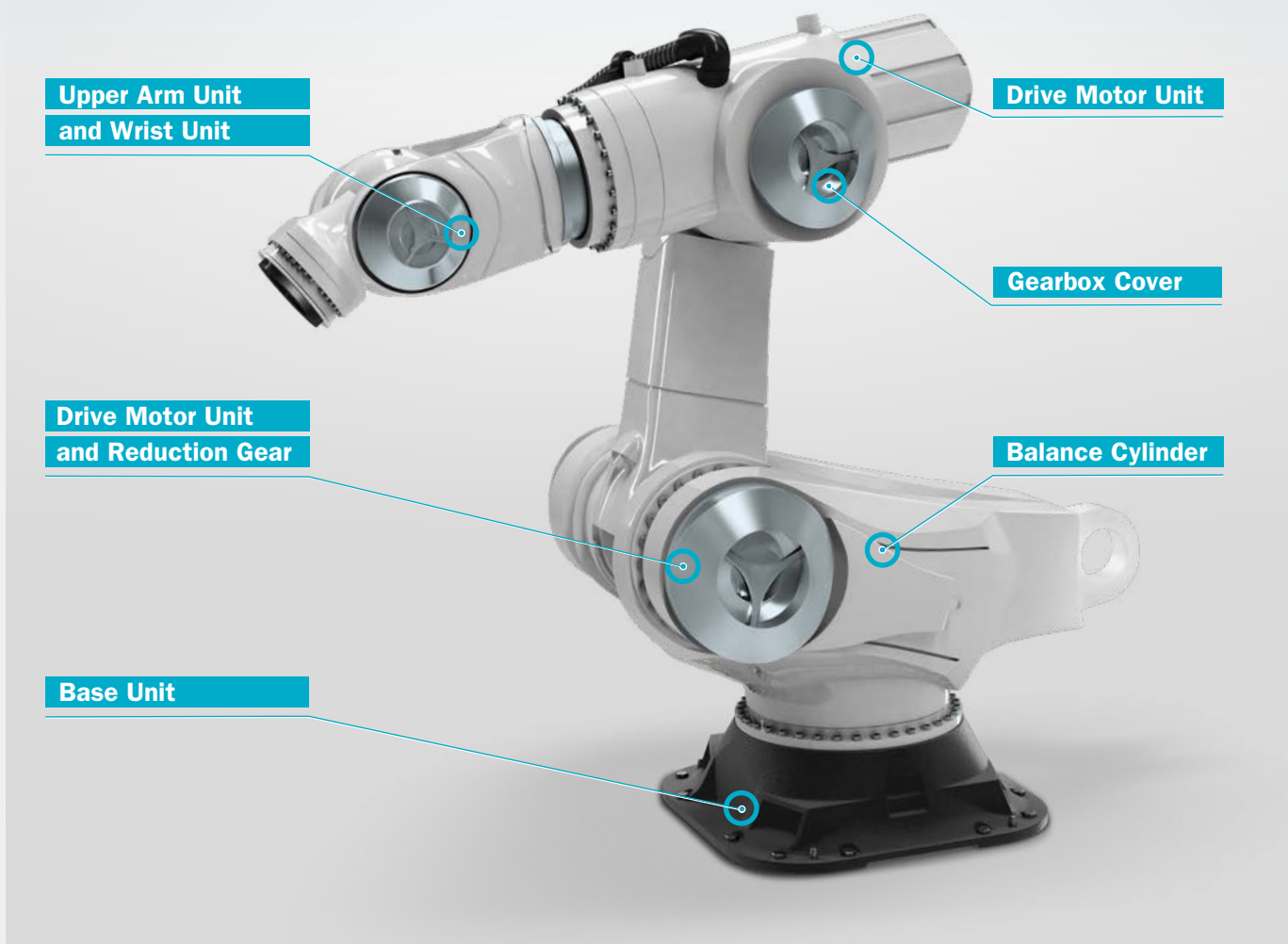

APPLICATIONS BY INDUSTRY

Industrial robotics	Medical, surgical, healthcare robotics and powered exoskeletons
Construction, disaster recovery, probe robotics	Surveillance, household, entertainment robotics
Drones, personal mobility robotics	Robotics related components

ROBOTICS AUGMENTED REALITY APP

To easily access the Robotics AR app, download our AR Literature App. Just search for the AR Literature App on Apple iTunes or Google Play or scan the code.

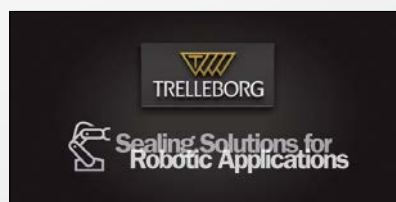

Manufacturing & Machine Tools

We offer our know-how and long-standing experience on standard products, project development and realization of solutions for specific sealing systems with unique requirements.

For further literature, films and digital tools, please scan the QR-Code:



Linear Seals

- Wide range of rod and piston seals
- Turcon® Stepseal® V in Turcon® M12
- Zurcon® RU 9 in Z20
- Turcon® Glyd Ring® T in Turcon® T46
- Zurcon® Glyd Ring® D in Zurcon® Z13
- Zurcon® Scraper DA24 in Z25



Rotary Seals

- Standardized oil seals
- Pressure rotary seals in various materials for standardized glands
- Turcon® Roto Glyd Ring® S



Guiding Elements and Static Seals

- Orkot®
- HiMod®
- Turcite®



Materials

- Wide range of static seals in elastomer, TPU, PTFE and steel grades
- FKM iXLT V8T71
- Turcon® M12
- Zurcon® Z13, Z25
- Orkot® C480

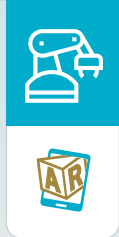

APPLICATION HIGHLIGHT: INJECTION MOLDING MACHINE

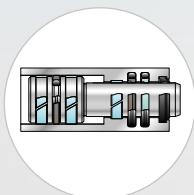

Lock Cylinder

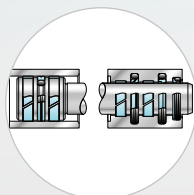

Clamp Cylinder

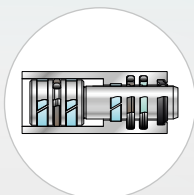

Ejector Cylinder

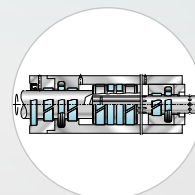

Rotating Mold
Injection Unit

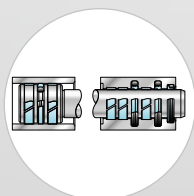

Traverse Cylinder

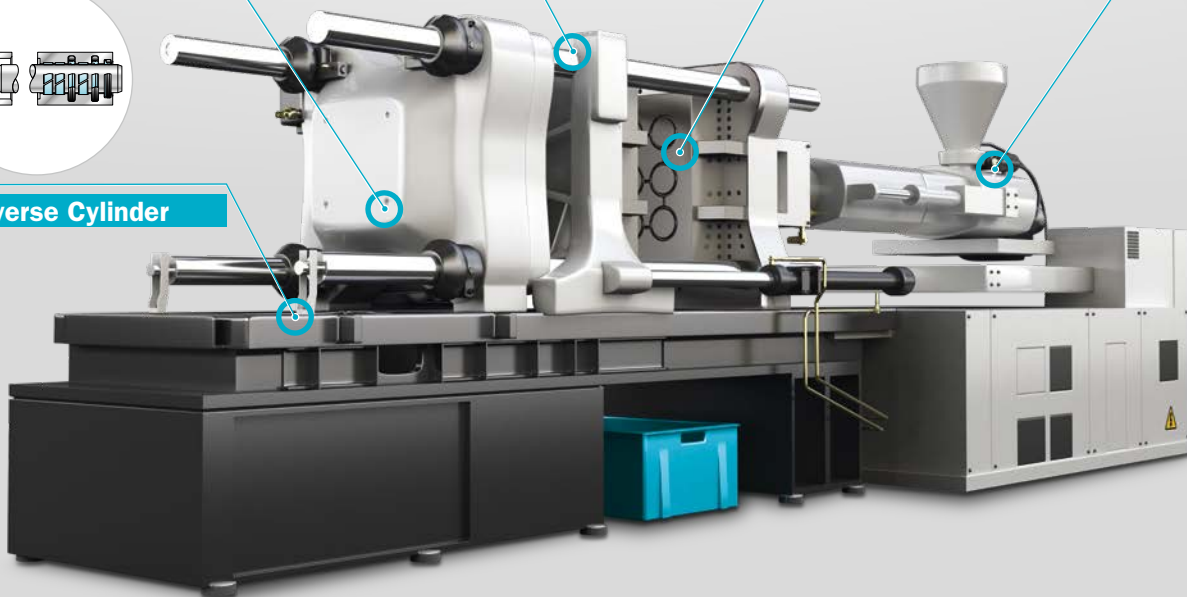

MOST COMMON APPLICATIONS

Presses

Machines for the metal, wood, textile and paper industries

Casting, foaming, blowing and extruding machines

Component finishers

HYDRAULIC SYSTEM CALCULATOR



For information about our Hydraulic System Calculator, scan the QR-Code or visit our website: www.trelleborg.com/seals



Marine Equipment & Construction

Several parts of Trelleborg Group, including Trelleborg Sealing Solutions, have been active within the marine and shipping industries for over 25 years.

For further literature, films and digital tools, please scan the QR-Code:



Rudder Bearings

- Long service life
- Dry running or lubricated
- Can be used in all rudder designs
- Classification approvals
- Extensive reference base
- SEAL compliant
- Fast delivery

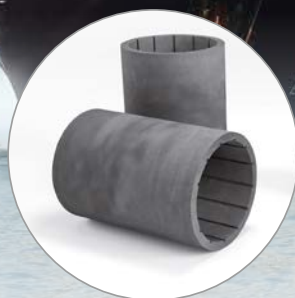

Propeller Shaft Bearings

- Different grades to suit environmental requirements
- Patented key design
- Can be shipped as raw material or as finished bearings
- Low coefficient of friction during start and stop



Deck Machinery

- High load capability
- Dry running or grease lubricated
- Low friction
- Maintenance-free



Crane

- Easy installation via freeze fitting
- High load capability
- Accepts misalignment
- Low stick-slip effects
- Custom design



APPLICATION HIGHLIGHT: PROPELLER SHAFT AND RUDDER BEARINGS



Water-lubricated Propeller Shaft Bearings

- No need for lubricants, which can be an environmental risk
- Maintenance-free long service life
- Orkot® and bronze cassettes for easy assembly

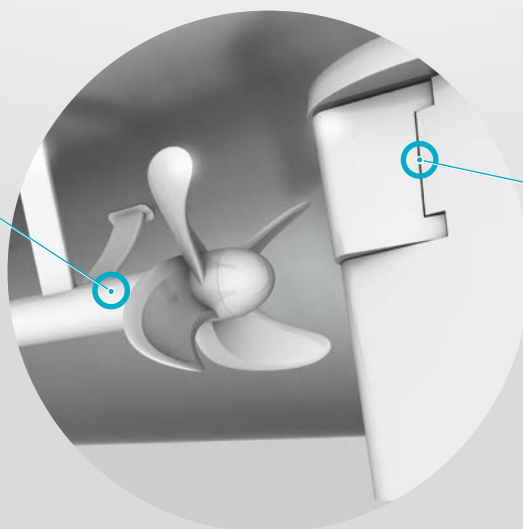

Rudder Bearings

- Grease lubricated, dry or wet operation
- Highest approved bearing loads with Classification Societies
- Fast track support with dedicated order hotline

APPLICATION HIGHLIGHT: STERN ROLLER BEARINGS

- Variable friction ensures turning of roller with low or high loads
- Slow and fast momentum
- SEAL compliant
- Wear resistant



MOST COMMON APPLICATIONS

Propeller shaft bearings	Stern roller bearings	Hydrofoil wing bearings
Vessel stabilizer bearings	Deck machinery	Sea crane bearings
Rudder bearings	Hatch pad covers for container vessels	Shaft coupling covers

Material Handling

For further literature, films and digital tools, please scan the QR-Code:



Based on know-how and long-standing expertise, Trelleborg Sealing Solutions offers a range of standard and custom products to meet the demands of material handling equipment.



Engineered Molded Parts

Custom-designed components are designed to meet your individual needs. Developed in cooperation with our engineering teams, they can provide significant benefits from a function, manufacturing or performance perspective.



Cassette Seal

For use in heavy-duty vehicle axles, hubs and industrial gearboxes, cassette seals offer long service life, high functional reliability, environmental safety and easy installation.



Radial Oil Seal

Providing long-lasting sealing efficiency, they are designed for sealing shafts and spindles and consist of a rubber sealing lip, metal case, a spiraled tensioning spring and are available with or without an external dust lip.



Orkot® Slydring®

Made of a resin-impregnated fine-weave fabric material with added lubricants, this wear ring prevents metal-to-metal contact in hydraulic cylinders and is capable of withstanding high loads.



Dualseal

A single seal element for static applications, this seal offers resistance to twisting, easy installation and long service life, and is recommended for heavy duty applications.

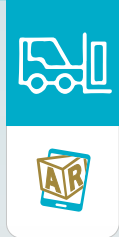

APPLICATION HIGHLIGHT: FORKLIFT



MOST COMMON APPLICATIONS

Side loaders	Bucket elevators
Conveyance systems	Aerial man lifts
Cranes	Automatic Guided Vehicles

MATERIAL HANDLING BROCHURE



For information about material handling, scan the QR-Code or visit our website:
www.trelleborg.com/seals



Semiconductor

Our extensive range of innovative seal materials and products gives exceptional sealing integrity in the most demanding of semiconductor manufacturing environments.

For further literature, films and digital tools, please scan the QR-Code:



O-Rings/Static Seals

- Wide range of O-Rings that balance cost-effectiveness with performance
- Cleanroom manufacturing
- FlexiMold™ – Large diameter O-Rings and other sealing profiles without dedicated tool set-up
- Variseal® NW – Flange seal with exceptional chemical resistance



Complex Engineered Molded Parts

- Advanced design capabilities
- Complex shapes
- Rubber-to-Metal and Rubber-to-Plastic options
- High purity products

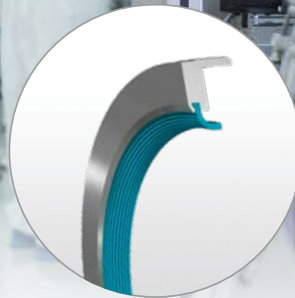

Rotary Seals

- Low friction to facilitate reduced power loss and friction-induced heat
- Dry running capability
- Turcon® material compatible with virtually all media
- Example: Turcon® Varilip® PDR



Materials

- Extensive range of high-performance materials
- Isolast® FAB Range (FFKM)
- Unique Turcon® PTFE based compounds for dynamic and rotating applications
- Almost universal chemical resistance
- Ultra-high purity compounds
- Resistance to dry and wet process chemistry

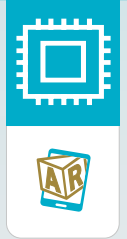

APPLICATION HIGHLIGHT: VACUUM PUMP

**Isolast® FFKM or
FKM O-Ring**

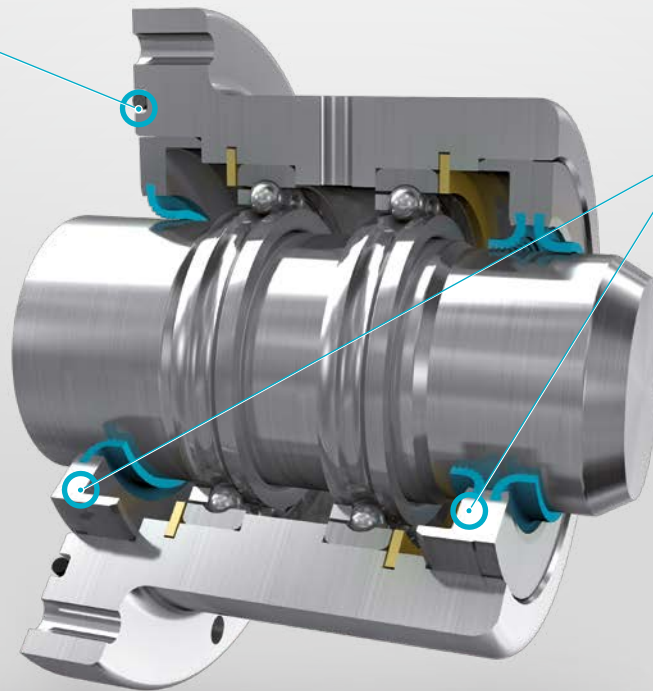

Turcon® Varilip® PDR

MOST COMMON APPLICATIONS

Aggressive plasma processes	Wet chemical processes
Thermal processes	Sub fab processes

Water

Compatibility and cleanliness are of ultimate concern when developing sealing solutions for potable water and sanitary applications. Consequently, based on our longstanding experience, we have developed an outstanding range of seals and sealing materials.

For further literature, films and digital tools, please scan the QR-Code:



O-Rings/Static Seals

- Versatile sealing element
- Cost effective solution
- Minimize hardware and design costs
- Compact design
- Easy installation
- Materials specific for food and beverage applications



Molded Parts/Liquid Silicone Rubber

- High product purity and cleanliness with cleanroom manufacturing
- Custom-designed to application conditions
- Complex shapes, thin sections and parts with undercuts
- Flashless molding and fully automated production possible



Linear & Rotary Seals

- Linear seals for dynamic or static applications
- Stick-slip free operation
- Very low friction
- Very good thermal resistance
- High resistance to wear and aging
- Long service life
- Universal chemical compatibility



Bearings

- High load bearing capacity
- High wear resistance and long service life
- Very low friction characteristics
- Unique self-lubricating and composite materials available
- Universal chemical compatibility

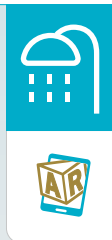

APPLICATION HIGHLIGHT: HEATING SYSTEM & PUMPS

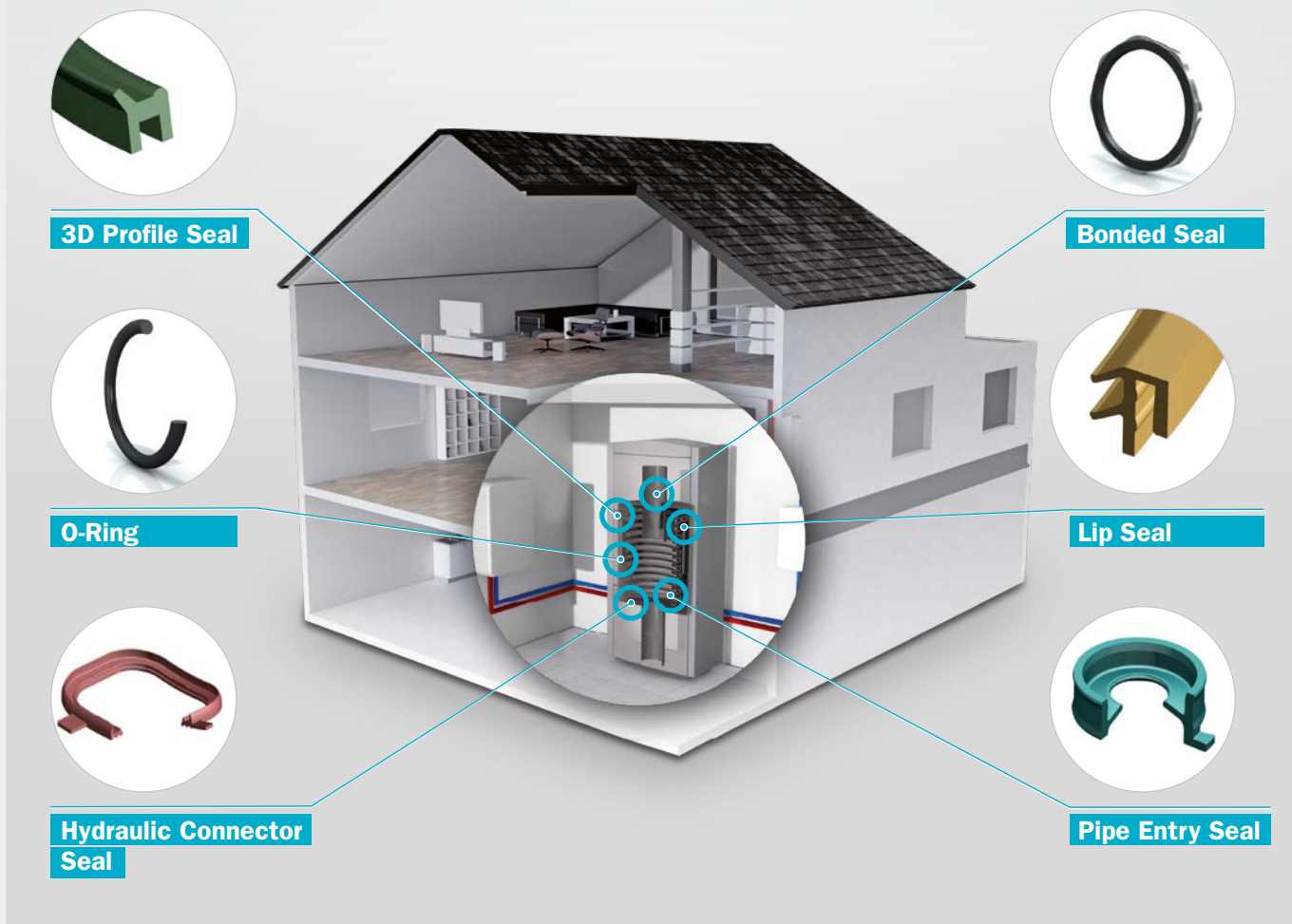

MOST COMMON APPLICATIONS

<p>Pumps and Valves Rotary Seals, Diaphragms, Custom Molded Parts</p>	<p>Water heaters O-Rings and Custom Molded Parts</p>
<p>Water filtration O-Rings, Custom O-Rings and Custom Molded Parts</p>	<p>Water irrigation Homogeneous and fabric reinforced diaphragms, O-Rings</p>
<p>Water fixtures O-Rings, LSR Custom Molded Parts, Two-Component Parts</p>	

Solutions & Capabilities, Brands & Materials

Decades of experience designing and manufacturing polymer solutions to meet the changing needs of our customers, as well as the latest industry trends and regulations, has led Trelleborg Sealing Solutions to develop, manufacture and supply a range of unique materials and proprietary product designs, many of which have become industry standards.

STANDARD PRODUCTS



Linear Seals



Bearings & Bushings



O-Rings & Static Seals



Rotary Seals

CUSTOMIZED SOLUTIONS (MAKE-TO-PRINT, MAKE-TO-DESIGN)



Engineered Molded Parts



Liquid Silicone Rubber (LSR) Components



Aerospace Solutions



Healthcare & Medical Solutions



Brake Shims, Tuned Absorbers, Rubore® Seals



Custom HMF FlatSeal™ Gaskets



Micro Parts



Assembly Units

ADVANCED CAPABILITIES

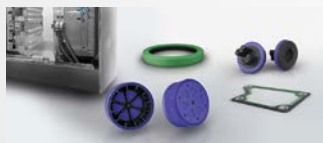

Multicomponent Technology



Cleanroom Production, Packaging, Assemblies



High Performance Polymers



Advanced Composites

WORLD RENOWNED NAMES UNITED

We own many of the longest established and leading names.

These include:

- American Variseal
- Automated Dynamics
- Busak+Shamban
- Dowty Seals
- Chase Walton
- Forsheda
- GNL
- Impervia
- Minnesota Rubber & Plastics
- Nordex
- Orkot
- Palmer Chenard
- Polypac
- SSF
- SF Medical
- Shamban
- Silcofab
- Silcotech
- Sil-Pro
- Skega
- Stefa
- Wills

PROPRIETARY MATERIALS & MATERIAL FAMILIES

Ongoing development has yielded some of the most successful sealing, bearing and custom materials available:

- HiMod®
- HiPlast®
- Isolast®
- Orkot®
- Turcite®
- Turcon®
- Turel®
- Zurcon®
- BioPharmaPro™
- FoodPro®
- H₂Pro™
- PureFab™
- Rubore®
- XploR™



One-Stop-Shop for Sealing Solutions

Scan the QR-Code or visit our website to find out more about our portfolio of solutions for industry-specific needs and applications.

www.trelleborg.com/seals

! This page is intentionally left blank.



Engineered Seals, Gaskets & other Parts

For further literature,
films, and mobile tools
for engineered seals,
gaskets and other parts,
scan the QR-Code:





Engineered Molded Parts

MATERIALS: Elastomeric, Polyurethane, Other Polymeric

Customized seals and other components in a wide range of standard and specialized elastomers, including Isolast®, are manufactured to close tolerances for all types of industries and applications. As your development partner, Trelleborg Sealing Solutions can work with you to design, develop and supply custom engineered molded parts to suit your application requirements.

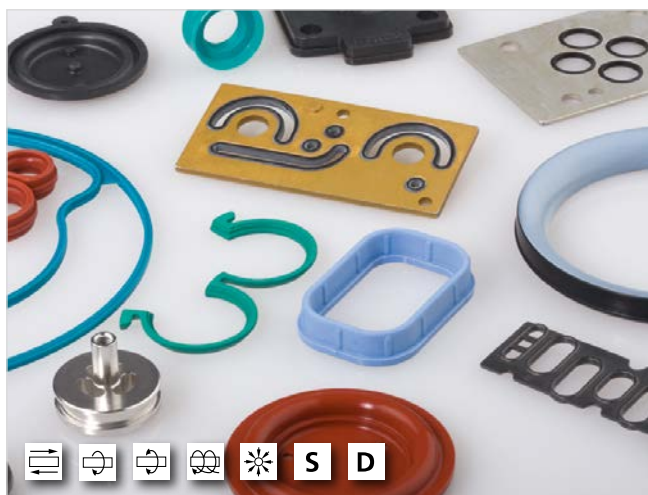

Temperature Range

up to +325 °C

up to +617 °F



Engineered PTFE Components

MATERIAL: PTFE

A wide range of filled and unfilled engineered PTFE components are made available to all types of industry. They include valve seats, pump diaphragms, chevron packings, nozzles, bellows, guides, bearings and electrical insulators. These are developed in conjunction with Trelleborg Sealing Solutions to the specific requirements of the customer.

APPLICATIONS: various custom applications



Temperature Range

up to +260 °C

up to +500 °F



Engineered Radial Oil Seal

MATERIAL: Elastomeric, Metal

Engineered ROS developed according to special working conditions, in terms of design and materials.

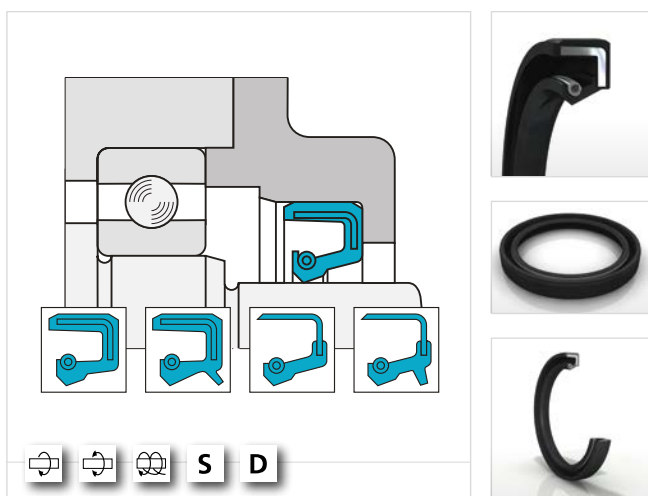

Ø Range	Pressure Range	Temperature Range	Velocity
up to 500 mm	up to 200 bar	-60 °C +250 °C	up to 30 m/s
up to in	up to psi	-75 °F to +480 °F	up to ft/s

* temperature range of the compound

KEY TO APPLICATIONS: Reciprocating = Rotary = Oscillating = Helix = Static = Single-acting = **S** Double-acting = **D**

HMF FlatSeal™

MATERIALS: Fiber, Graphite, PTFE, Mica and Elastomeric

Flat gaskets are used to seal housings, flanges in pipework, covers and lids, for example.

A wide range of material types is available to meet specific requirements and regulations for multiple industries.

APPLICATIONS: aerospace, automotive, chemical and processing, energy, oil and gas, food, beverage and pharmaceutical

Pressure Range	Temperature Range
up to 25 MPa	-270 °C +1,000 °C
up to 3,625 psi	-454 °F +1,832 °F

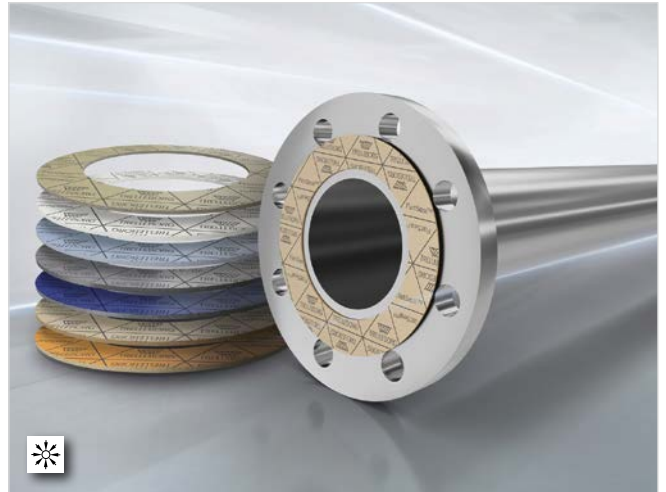

Rubber-to-Metal Bonded Parts

MATERIALS: PTFE, Elastomeric, Other Polymeric, Metal

In many applications, a composite molded part has advantages in terms of technical robustness, quality, performance and total cost of ownership. Bonding of either standard or specialized elastomers, including Isolast®, is feasible with a large variety of metals and thermoplastics. As your development partner, Trelleborg Sealing Solutions can work with you to design and develop products to suit your application requirements.

APPLICATIONS: various custom applications across all industries from a wide range of materials

Temperature Range
-60 °C +325 °C
-76 °F +617 °F

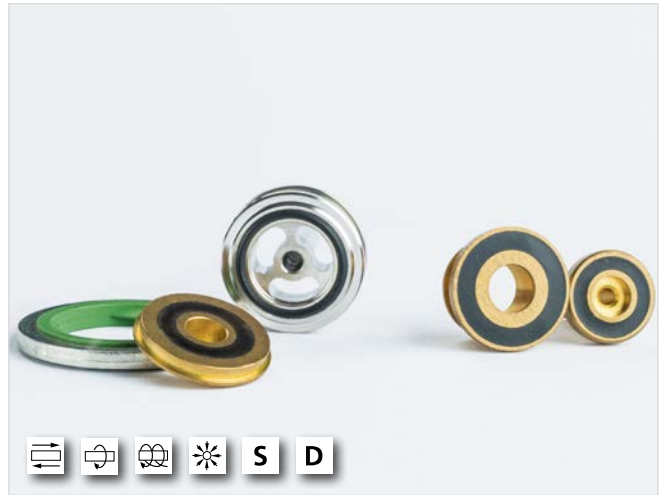

Rubber and Rubber-to-Metal Bonded Gaskets

MATERIALS: Elastomeric, Metal

Precision homogeneous or Rubber-to-Metal bonded gaskets are custom molded from a variety of elastomers for high-performance engine and other applications. Metals such as cold-rolled or stainless steel, brass or aluminum can be offered and bonded to any elastomer. As your development partner, Trelleborg Sealing Solutions can work with you to design, develop and supply gaskets to suit your application requirements.

Temperature Range
-60 °C +325 °C
-76 °F +617 °F



KEY TO APPLICATIONS: Reciprocating = Rotary = Oscillating = Helix = Static = Single-acting = **S** Double-acting = **D**

Plate Heat Exchanger Gaskets

MATERIALS: NBR, HNBR, EPDM, CR, IIR, FKM, AFLAS, VMQ

Plate heat exchangers offer a highly efficient means of heating or cooling fluid media. Plate heat exchangers employing gaskets between the heating and cooling plates are widely used in many types of industry.

APPLICATIONS: chemical processing, food and beverage, HVAC, oil and gas, refrigeration, marine

Ø Range	Pressure Range	Temperature Range
Length: up to 2900 mm or higher (by joining) Width: up to 1450 mm	0 to 50 bars	-60 °C +200 °C
Length: up to 114 in or higher (by joining) Width: up to 57 in	0 to 725 psi	-76 °F to +392 °F

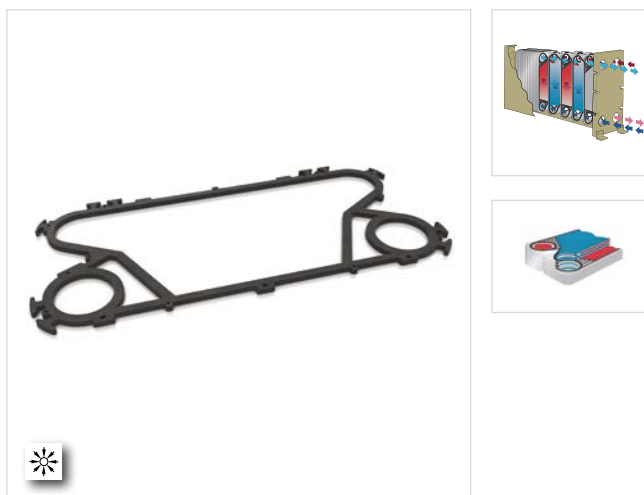

Ground Balls

MATERIAL: Elastomeric

Ground Balls are rubber spheres of high dimensional accuracy. They guarantee sealing without leaks, are resistant to dirt and produce little noise. Ground Balls are used primarily as sealing elements in non-return check valves to seal against hydraulic fluid, water or air.

APPLICATIONS: check valves



Temperature Range

-30 °C +200 °C

-22 °F +392 °F



Diaphragms

MATERIALS: PTFE, Elastomeric, Polyurethane, Other Polymeric, Metal

Diaphragms are available in many designs, in a variety of homogeneous or fabric reinforced elastomers. Challenging applications are solved through composite design and material technology, including the application of PTFE and other barrier materials for chemically aggressive environments. Plastic or metal-to-rubber bonding can be incorporated in assembly and provide precision control of movement or pressure.

APPLICATIONS: pumps, valves, regulators and actuators

Pressure Range (Not reinforced)	Pressure Range (Not reinforced)	Temperature Range
up to 0.05 MPa	10 MPa	-50 °C +325 °C
up to 7 psi	1,450 psi	-58 °F +617 °F



KEY TO APPLICATIONS: Reciprocating = Rotary = Oscillating = Helix = Static = Single-acting = **S** Double-acting = **D**



Engineered HiMod® High Modulus Plastics

MATERIAL: HiMod®

A wide range of high performance, high modulus thermoplastics are available for use as custom molded components, reinforcing rings and Back-up Rings. Grades can optimize operation on structural, chemical, electrical and high performance bearing applications.

Temperature Range

up to +300 °C

up to +572 °F



Liquid Silicone Rubber (LSR) Molded Parts

MATERIAL: Elastomeric

High-precision LSR parts, often delicate or micro-sized, are increasingly specified across many industrial sectors including medical and pharmaceutical, household appliances, electrical, and electronic. High-precision toolmaking and state-of-the-art fully automated liquid injection molding are the basis for custom-engineered parts into applications where consistent precision, quality and performance reliability in high quantities are critical in application.

APPLICATIONS: custom applications including life sciences, food and pharmaceutical, sanitary and automotive

Temperature Range

-40 °C +175 °C

-40 °F +347 °F

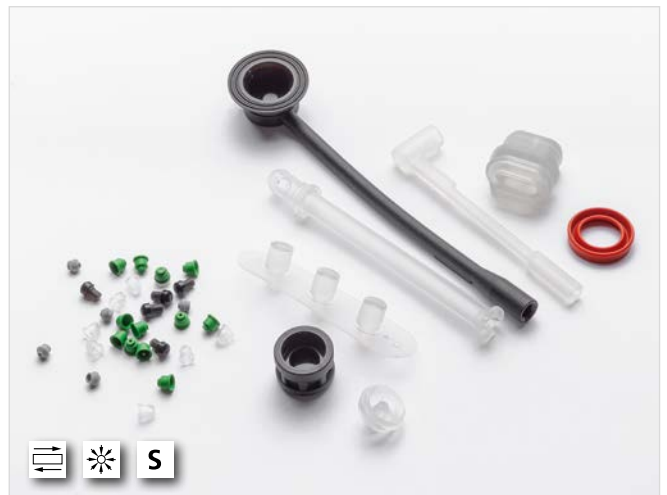

Multicomponent Solutions

MATERIALS: Elastomeric, Other Polymeric, FKM, EPDM, TPE, LSR

Specialized tool design and process engineering are the foundation of our advanced multicomponent injection technology, allowing the design and production of complex, high-precision hard-soft or soft-soft product solutions. Multicomponent solutions allow the integration of multiple functions into a single robust component. It increases design latitude and eliminates the need for secondary handling and assembly operations.





APPLICATIONS: various custom applications including life sciences, food and pharmaceutical and automotive

Temperature Range

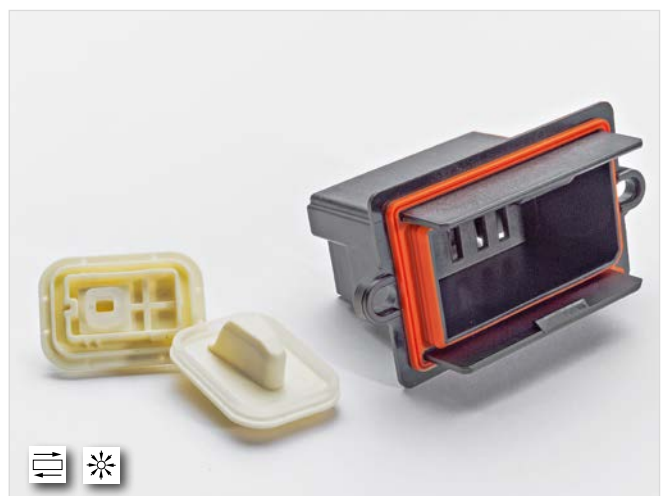
-40 °C +175 °C

-40 °F +347 °F



KEY TO APPLICATIONS: Reciprocating =  Rotary =  Oscillating =  Helix =  Static =  Single-acting = **S** Double-acting = **D**

Multicomponent Technology

Engineered One-piece Solutions for Integrated Functionality

now

**Improve performance and consolidate multiple functions
with a single engineered component.**

Trelleborg's multicomponent technology strongly bonds a range of high-specification polymers, chosen to meet your specific application requirements. Customizable seal geometries combine multiple features or seals to improve performance, ease assembly and reduce part handling. The seals produced are leak-free and need less space and assembly effort, making them a cost-effective sealing solution.

Scan the QR code to learn more about this technology.



Silicone Hose and Tube

MATERIAL: Elastomeric

A comprehensive range of platinum cured silicone hose and tube is produced to stringent performance and purity standards demanded by life sciences, biotechnology and pharmaceutical markets. PharmaTube™ is used either as singular tube or value-added tube sets and assemblies. Trelleborg Sealing Solutions can work with you to design, develop and supply a solution to suit your application requirements.

APPLICATIONS: medical tubing and profiles, reinforced hose, and related value-added assemblies

Temperature Range

-40 °C +175 °C

-40 °F +347 °F

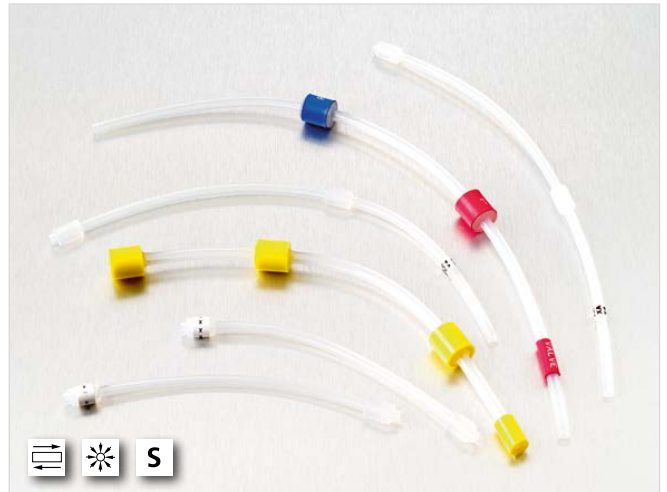

Silicone Braided Hose – single & double

MATERIAL: Elastomeric

A comprehensive range of platinum or peroxides cured silicone braided hose is produced to the most stringent performance and purity standards demanded in the life sciences, biotechnology, pharmaceutical and food & beverage markets. PharmaSil™ and NutraSil™ are used either as singular or double polyester braided hose and can be supplied with SilFit™ permanent or reusable fittings. Single or double braided hose or value-added hose assemblies with fittings can be used in a wide variety of applications such as media bulk transfer, food dispensing and higher pressure fluid transfer applications.

APPLICATIONS: healthcare and medical

Pressure Range

379 kPa – 1206 kPa

55 – 175 psi

Temperature Range

-62 °C +260 °C

-80 °F +500 °F



Rubore® Seals

MATERIALS: PTFE, Elastomeric, Metal

The Rubore® process is a unique rubber-metal layering technology permitting complex seal designs that have never before been possible. Rubore® Seals provide overall cost benefits, reducing weight and frequently eliminate the need for surface finishing and after treatments. The stiffness of the product reduces handling costs and logistics requirements, and makes automated seal installation achievable.





APPLICATIONS: rubber-metal composite for custom-made applications, various possible geometries and designs

Temperature Range

-40 °C +165 °C

-40 °F +329 °F



KEY TO APPLICATIONS: Reciprocating =  Rotary =  Oscillating =  Helix =  Static =  Single-acting = **S** Double-acting = **D**

! This page is intentionally left blank.



Hydraulic Seals – Piston Seals

For further literature, films, animations and mobile tools for piston seals, scan the QR-Code:



HYDRAULIC SYSTEM CALCULATOR



Our Hydraulic System Calculator helps you to calculate areas and volumes in the cylinder, extraction and retraction forces, time velocity and outflow.

For more information scan the QR-Code or visit our website: www.trelleborg.com/seals

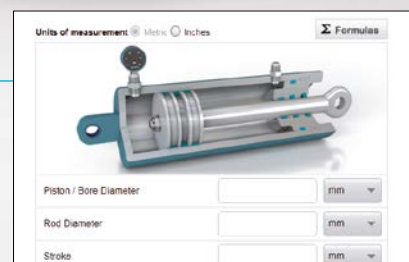



Turcon® Glyd Ring® T

MATERIALS: Turcon®, Zurcon®, Elastomeric

Turcon® Glyd Ring® T provides optimum leakage control and good resistance to extrusion. The seal is a double-acting O-Ring energized piston seal for dynamic applications. Installed in grooves to ISO 7425, it has excellent friction characteristics with no stick-slip, minimal breakout force and high wear resistance.

APPLICATIONS: hydraulics, general machine operation, machine tools, mobile hydraulics

Ø Range	Pressure Range	Temperature Range	Velocity
8 – 2,700 mm	60 MPa	-45 °C +200 °C	15 m/s
0.315 in – 105 in	8,700 psi	-49 °F +392 °F	50 ft/s

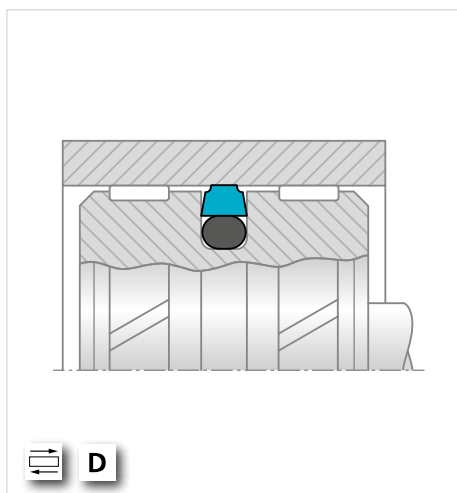

Turcon® Glyd Ring®

MATERIALS: Turcon®, Zurcon®, Elastomeric

Turcon® Glyd Ring® is a double-acting O-Ring energized piston seal for dynamic applications. Turcon® Glyd Ring® provides low friction with no stick-slip, minimal breakout force and high wear resistance. Main application is actuator cylinders. Installed in grooves to ISO 7425.

APPLICATIONS: hydraulics, general machine operation, machine tools, mobile hydraulics

Ø Range	Pressure Range	Temperature Range	Velocity
8 – 2,700 mm	60 MPa	-45 °C +200 °C	15 m/s
0.315 in – 105 in	8,700 psi	-49 °F +392 °F	50 ft/s

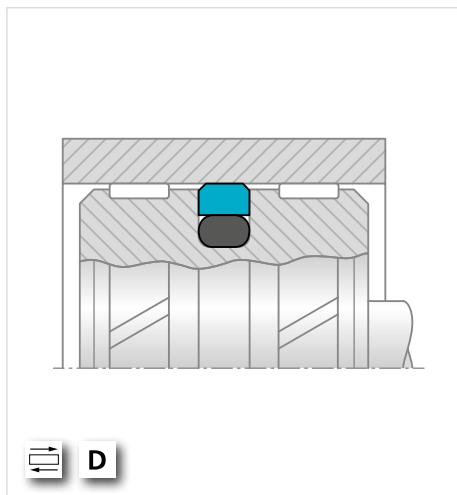

Turcon® Glyd Ring® Hz

MATERIALS: Turcon®, Zurcon®, Elastomeric

Turcon® Glyd Ring® Hz is a symmetric, double-acting seal which has design features to allow improved performance over a standard Turcon® Glyd Ring® in high frequency, short stroke applications.

APPLICATIONS: high frequency, short stroke applications

Ø Range	Pressure Range	Temperature Range	Velocity
8 – 999.99 mm	30 MPa	-45 °C +200 °C	15 m/s
0.315 in – 39.4 in	4,350 psi	-49 °F +392 °F	50 ft/s

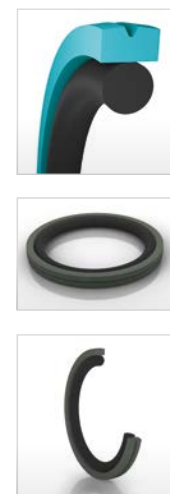
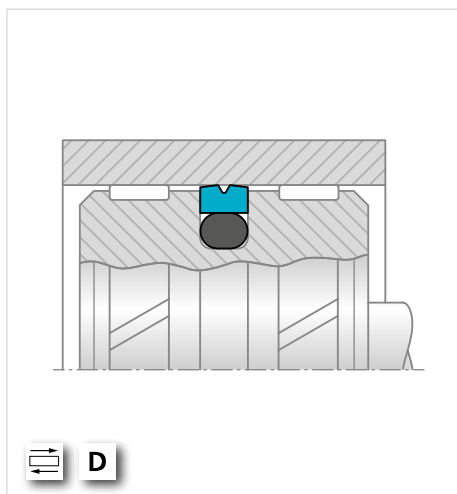

KEY TO APPLICATIONS: Reciprocating = Rotary = Oscillating = Helix = Static = Single-acting = **S** Double-acting = **D**



Turcon® Double Delta®

MATERIALS: Turcon®, Zurcon®, Elastomeric

The Turcon® Double Delta® is a double-acting sealing element which is energized by an elastomer O-Ring. The Turcon® Double Delta® seal can be fitted in existing O-Ring grooves (US standard AS 568 A, MIL-P-5514) and it demonstrates good friction properties, stick-slip-free starting and excellent dry running. The Turcon® Double Delta® is used in light and medium duty industrial hydraulics.

APPLICATIONS: hydraulics, light hydraulics, medium hydraulics

Ø Range	Pressure Range	Temperature Range	Velocity
5 – 1,000 mm	35 MPa	-45 °C +200 °C	15 m/s
0.196 in – 39.37 in	5,075 psi	-49 °F +392 °F	50 ft/s

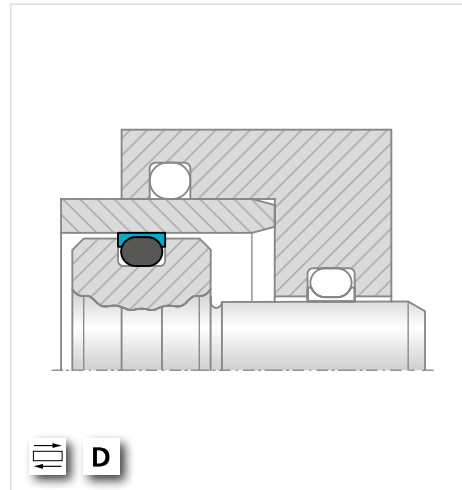

Turcon® Glyd Ring® II

MATERIALS: Turcon®, Zurcon®, Elastomeric

The Turcon® Glyd Ring® II is a double-acting, bi-directional seal for demanding applications. It consists of a permanently bonded elastomer energizer and a PTFE-based seal ring to form a one-piece seal.

APPLICATIONS: a bonded one-piece seal for all industries with demanding applications which require a custom solution

Ø Range	Pressure Range	Temperature Range	Velocity
2.5 – 1,016 mm	60 MPa	-60 °C +200 °C	15 m/s
0.100 in – 40.0 in	8,700 psi	-76 °F +392 °F	50 ft/s

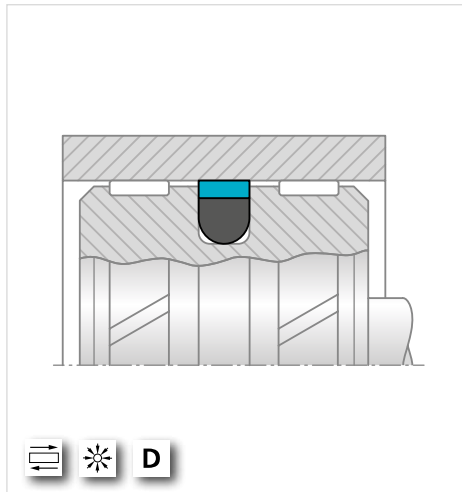

Turcon® AQ Seal®

MATERIALS: Turcon®, Zurcon®, Elastomeric

A double-acting O-Ring energized seal developed for sealing between two media such as fluid and gas. It incorporates a limited footprint Quad-Ring® / X-Ring inset into the dynamic sealing face. Installed in grooves to ISO 7425.

APPLICATIONS: hydraulics, medium operation, piston accumulators

Ø Range	Pressure Range	Temperature Range	Velocity
15 – 700 mm	50 MPa	-45 °C +200 °C	2 m/s
0.590 in – 27.5 in	7,250 psi	-49 °F +392 °F	6.5 ft/s

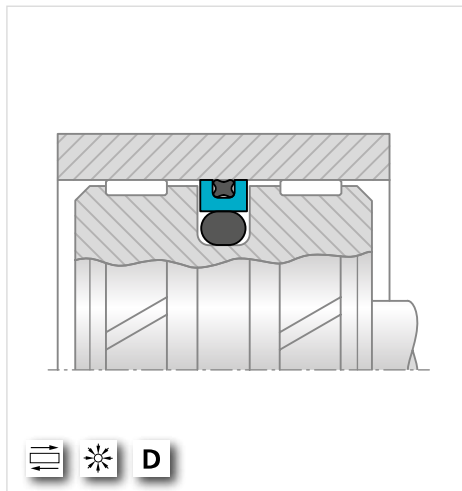

KEY TO APPLICATIONS: Reciprocating = Rotary = Oscillating = Helix = Static = Single-acting = **S** Double-acting = **D**



Turcon® AQ Seal® 5

MATERIALS: Turcon®, Zurcon®, Elastomeric

A further development of the standard Turcon® AQ Seal®, the double-acting Turcon® AQ Seal® 5 incorporates an elastomer Quad-Ring® / X-Ring and an elastomer or polyurethane Bean Seal in the dynamic sealing face. It is energized by two O-Rings to improve sealing behavior.

APPLICATIONS: hydraulics, fluid/gas separation, mobile hydraulics, heavy operation

Ø Range	Pressure Range	Temperature Range	Velocity
25 – 700 mm	60 MPa	-30 °C +200 °C	3 m/s
0.984 in – 27.5 in	8,700 psi	-22 °F +392 °F	10 ft/s

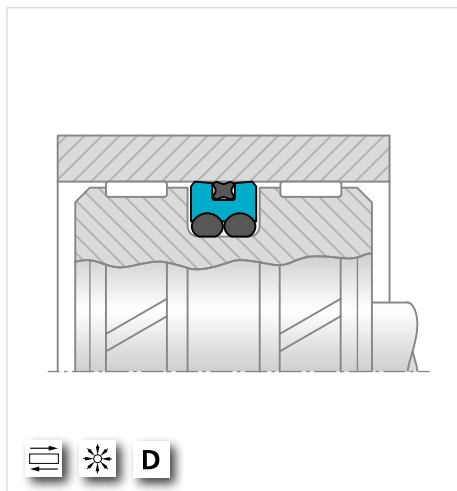

Zurcon® Wynseal

MATERIAL: Zurcon®, Elastomeric

A double-acting O-Ring energized piston seal in injection molded polyurethane for dynamic applications. Installed in grooves to ISO 7425, Zurcon® Wynseal offers high sealing efficiency, and is tear and abrasion resistant.

APPLICATIONS: hydraulics, light hydraulics, medium duty

Ø Range	Pressure Range	Temperature Range	Velocity
16 – 250 mm	25 MPa	-35 °C +110 °C	0.5 m/s
0.625 in – 10 in	3,626 psi	-31 °F +230 °F	1.6 ft/s

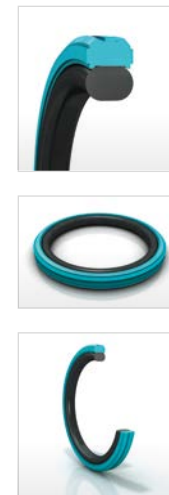
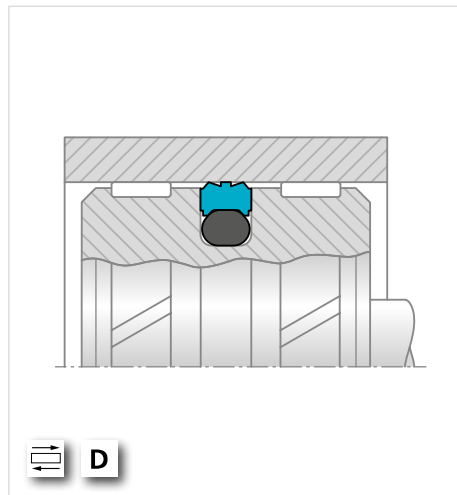

Zurcon® Wynseal M

MATERIALS: Turcon®, Zurcon®, Elastomeric

A double-acting O-Ring energized piston seal for dynamic applications in a machined version. All diameters up to 2,700 mm / 105 in. Installed in grooves to ISO 7425. High sealing efficiency in tear and abrasion resistant Zurcon® polyurethane. Also available in Turcon® materials.

APPLICATIONS: hydraulics, light hydraulics, medium duty

Ø Range	Pressure Range	Temperature Range	Velocity
8 – 2,700 mm	50 MPa	-45 °C +200 °C	10 m/s
0.315 in – 100 in	7,250 psi	-49 °F +392 °F	33 ft/s

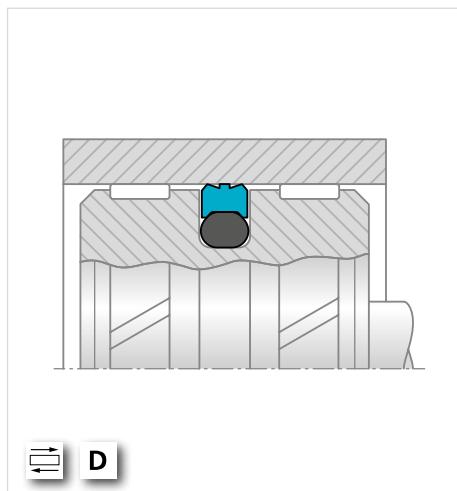

KEY TO APPLICATIONS: Reciprocating = Rotary = Oscillating = Helix = Static = Single-acting = **S** Double-acting = **D**



Zurcon® Glyd Ring® D

MATERIAL: Zurcon®, Elastomeric

Zurcon® Glyd Ring® D is a double-acting seal consisting of a premium polyurethane Zurcon® Z13 seal ring and an elastomer O-Ring as the energizing element. The innovative D-shaped design optimizes contact pressure and the two special grooves incorporated keep an oil reservoir for adequate lubrication that minimizes heat generated by friction forces.

APPLICATIONS: construction machinery, earth moving equipment, mobile hydraulics, truck cranes, forklifts

Ø Range	Pressure Range	Temperature Range	Velocity
15 – 400 mm	up to 60 MPa	-30 °C +110 °C*	0.5 m/s
0.5 in – 5 in	8,700 psi	-22 °F +230 °F	1.6 ft/s

* Depending on O-Ring Energizer Low Temperature can decrease to -45°C (-50°F)

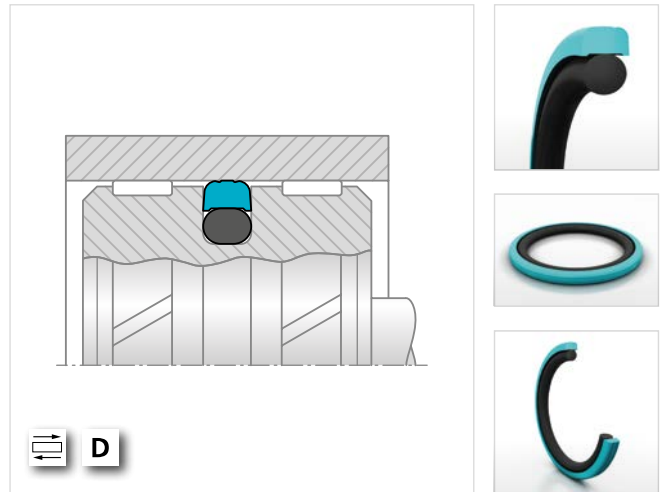

Zurcon® Glyd Ring® P

MATERIAL: Zurcon®, Elastomeric

The double-acting Zurcon® Glyd Ring® P is a combination of a Zurcon® based material slipper-seal with a step cut and an energizing rectangular elastomer ring. The high strength of Zurcon® means there can be a two-times larger extrusion gap compared with Turcon® materials. The step cut in the ring is necessary for installation in closed grooves and to give flexibility to this very stiff material.

APPLICATIONS: mobile hydraulics, construction machinery

Ø Range	Pressure Range	Temperature Range	Velocity
45 – 190 mm	50 MPa	-30 °C +110 °C	1 m/s
1.75 in – 7.5 in	7,250 psi	-22 °F +230 °F	3 ft/s



Compact Seal POLYPAC® DBM

MATERIALS: Zurcon®, HiMod®, Elastomeric, Other Polymeric

Double-acting compact piston seal assemblies consisting of an elastomer piston seal, two thermoelastomeric Back-up Rings and two thermoplastic wear rings. They are installed in closed grooves.

APPLICATIONS: hydraulics, standard cylinder, light to medium duty

Ø Range	Pressure Range	Temperature Range	Velocity
20 – 250 mm	35 MPa	-35 °C +100 °C	0.5 m/s
0.800 in – 10 in	5,075 psi	-31 °F +212 °F	1.6 ft/s

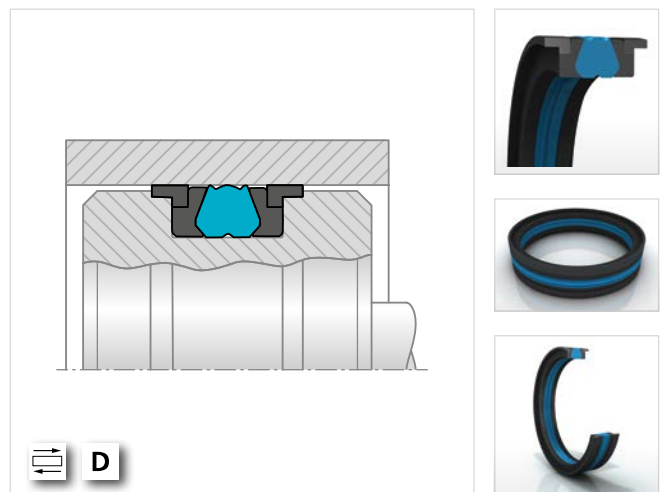

KEY TO APPLICATIONS: Reciprocating = Rotary = Oscillating = Helix = Static = Single-acting = **S** Double-acting = **D**



POLYPAC® PHD/CST Seal

MATERIALS: Turcon®, Zurcon®, PTFE

A heavy duty compact double-acting piston seal, the Polypac® PHD/CST Seal is an elastomer energized PTFE assembly. It gives stability, wear resistance, sealability, low friction and a maintenance-free long life. HiMod® Back-up Rings are specially designed to protect the seal ring from extrusion, even in the most demanding applications. Available in metric and inch sizes.

APPLICATIONS: hydraulics, mobile hydraulics, construction machinery

Ø Range	Pressure Range	Temperature Range	Velocity
50 – 180 mm	40 MPa	-45 °C +135 °C	1.5 m/s
2 in – 7 in	5,800 psi	-49 °F +275 °F	5 ft/s

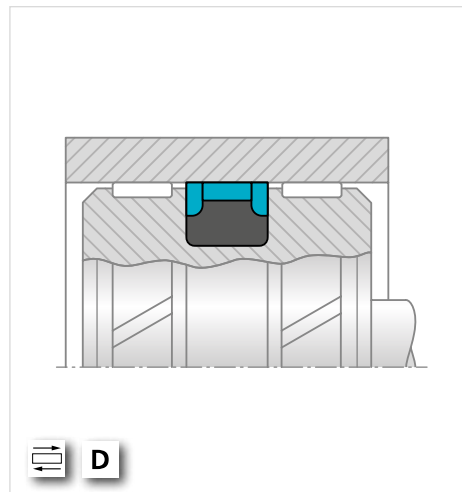

Turcon® Stepseal® 2K

MATERIALS: Turcon®, Zurcon®, Elastomeric

A single-acting O-Ring energized piston seal for dynamic applications installed in closed grooves, including grooves to ISO 7425. Turcon® Stepseal® 2K offers high sealing efficiency, low friction with no stick-slip, minimal breakout force and high wear resistance. Optimum sealing characteristics are achieved by installing in a tandem Turcon® Stepseal® or Rimseal arrangement together with a double-acting scraper. Available in Turcon® or Zurcon® materials.

APPLICATIONS: hydraulics, general machine operation, machine tools, mobile hydraulics

Ø Range	Pressure Range	Temperature Range	Velocity
8 – 2,700 mm	60 MPa	-45 °C +200 °C	15 m/s
0.315 in– 105 in	8,700 psi	-49 °F +392 °F	50 ft/s

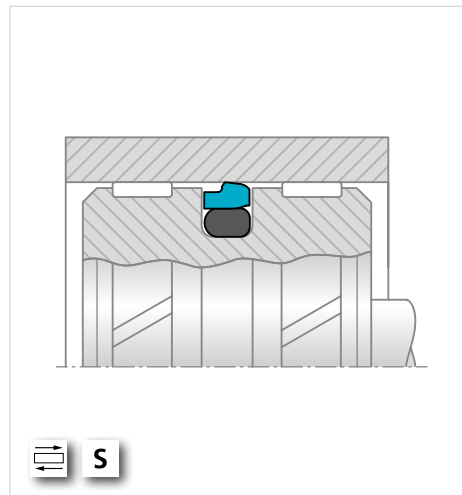

Turcon® Stepseal® V

MATERIALS: Turcon®, Zurcon®, Elastomeric

A single-acting O-Ring energized piston seal with hydrostatic pressure relief channel for dynamic applications. It prevents pressure trapping between seals under all service conditions. Installed in closed grooves, including grooves to ISO 7425, Turcon® Stepseal® V offers high sealing efficiency. It also has low friction with no stick-slip, minimal breakout force and high wear resistance.

APPLICATIONS: hydraulics, general machine operation, machine tools, mobile hydraulics

Ø Range	Pressure Range	Temperature Range	Velocity
15 – 2,700 mm	60 MPa	-45 °C +200 °C	15 m/s
0.600 in – 105 in	8,700 psi	-49 °F +392 °F	50 ft/s

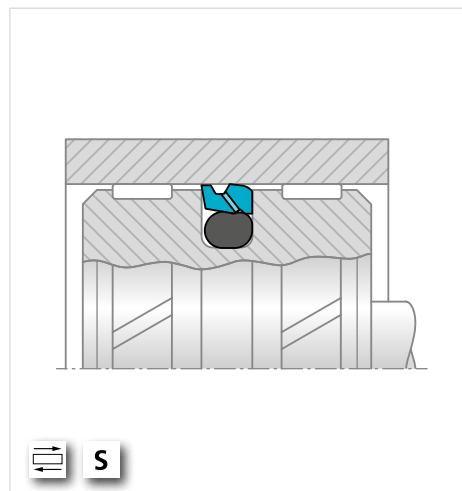

KEY TO APPLICATIONS: Reciprocating = Rotary = Oscillating = Helix = Static = Single-acting = **S** Double-acting = **D**



Zurcon® Rimseal

MATERIAL: Zurcon®, Elastomeric

Zurcon® Rimseal is a single-acting piston seal energized by an elastomer O-Ring with high static and dynamic tightness. Installation spaces are identical to those used for the Turcon® Stepseal® 2K, making Zurcon® Rimseal an ideal secondary system element. Applications include piston seals with redundant sealing systems and double wipers in mobile hydraulics, machine tools and injection molding machines.

APPLICATIONS: hydraulics, general machine operation, machine tools, mobile hydraulics

Ø Range	Pressure Range	Temperature Range	Velocity
8 – 2,200 mm	60 MPa (in tandem)	-45 °C +110 °C	5 m/s (in tandem)
0.315 in – 87 in	8,700 psi (in tandem)	-49 °F +230 °F	16 ft/s (in tandem)

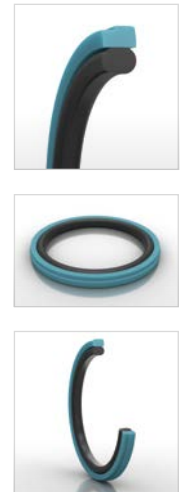
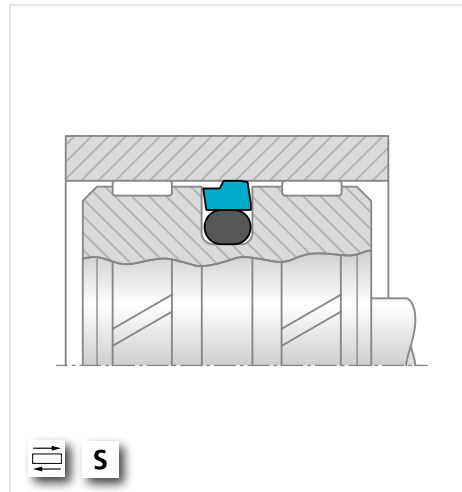

Zurcon® Rimseal IM

MATERIAL: Zurcon®, Elastomeric

Zurcon® Rimseal IM is a single-acting piston seal energized by an elastomer O-Ring with good static and dynamic tightness. It is optimized for injection molding technology and improves contact pressure distribution with improved back pumping and extrusion behavior. Installation grooves are identical to those used for Turcon® Stepseal® 2K, making Zurcon® Rimseal an ideal secondary seal. Zurcon® Z13 allows the seal to withstand higher temperatures and many hydraulic media.

APPLICATIONS: hydraulics, construction machinery, mobile hydraulics, machine tools

Ø Range	Pressure Range	Temperature Range	Velocity
8 – 999.9 mm	60 MPa (in tandem)	-45 °C +110 °C*	5 m/s (in tandem)
0.315 in – 39 in	8,700 psi (in tandem)	-49 °F +230 °F	16 ft/s (in tandem)

* Depending on O-Ring Energizer Low Temperature can decrease to -45°C (-50°F)

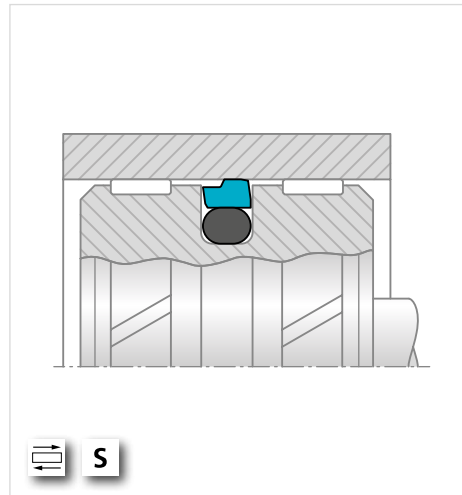

Zurcon® U-Cup PUA

MATERIAL: Zurcon®

Zurcon® U-Cup is a single-acting polyurethane piston seal that is available in a wide range of sizes. The seal is suitable for assembly into closed grooves and mainly used in light-duty cylinder applications in mobile equipment.

APPLICATIONS: fluid power, hydraulic cylinders, general maintenance

Ø Range	Pressure Range	Temperature Range	Velocity
14 – 250 mm	40 MPa	-35 °C +110 °C	0.5 m/s
0.550 in – 10 in	5,800 psi	-31 °F +230 °F	1.6 ft/s

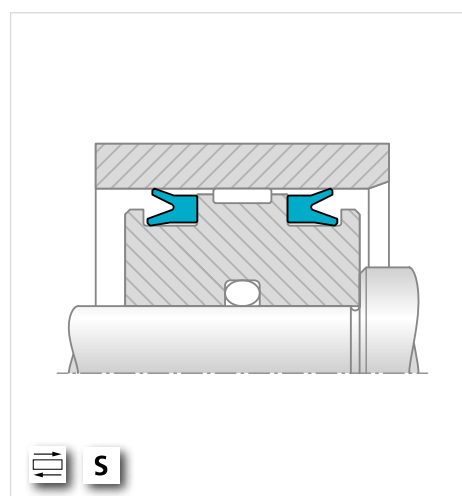

KEY TO APPLICATIONS: Reciprocating = Rotary = Oscillating = Helix = Static = Single-acting = **S** Double-acting = **D**



Turcon® Variseal® M2

MATERIALS: Turcon®, Zurcon®, Metal

A single-acting sealing element comprised of a U-shaped Turcon® ring and metallic energizing finger spring. It offers low friction with no stick-slip, minimal breakout force and high wear resistance. Resistant to most liquids and chemicals, it has an unlimited shelf life.

APPLICATIONS: hydraulics, chemical industry, aggressive media

Ø Range	Pressure Range	Temperature Range	Velocity
6 – 3,300 mm	D: 20 MPa S: 40 MPa	-70 °C +300 °C	L: 15 m/s R/O/H: 1.3 m/s
0.236 in – 130 in	D: 2,900 psi S: 5,800 psi	-94 °F +572 °F	L: 50 ft/s R/O/H: 4.2 ft/s

S = Static, D = Dynamic, L = Linear, R/O/H = Rotary/Oscillating/Helix

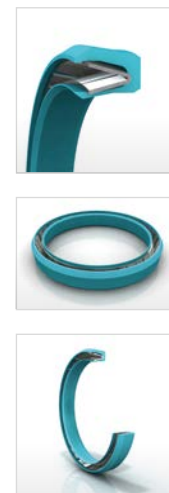
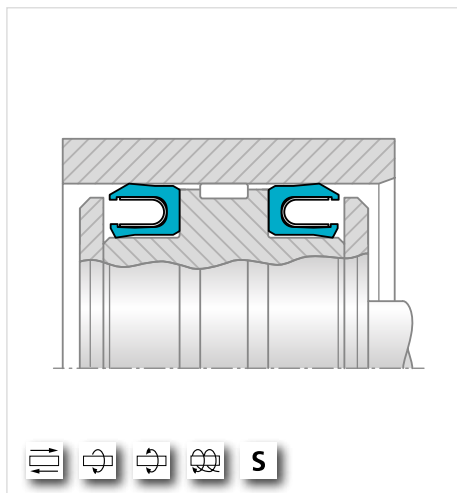

Turcon® Variseal® W2

MATERIALS: Turcon®, Zurcon®, Metal

Turcon® Variseal® W2 is a single-acting rod seal energized by a slantcoil spring. The advantage of the Turcon® Variseal® W2 lies in its low friction and relatively constant preloading force over a relatively large deformation range. The seal is used wherever friction has to be kept within a narrow tolerance zone, for instance in pressure switches.

APPLICATIONS: chemical industry, general mechanical applications

Ø Range	Pressure Range	Temperature Range	Velocity
3 – 3,300 mm	D: 20 MPa S: 40 MPa	-70 °C +300 °C	L: 15 m/s R/O/H: 1.3 m/s
0.118 in – 130 in	D: 2,900 psi S: 5,800 psi	-94 °F +572 °F	L: 50 ft/s R/O/H: 4.2 ft/s

S = Static, D = Dynamic, L = Linear, R/O/H = Rotary/Oscillating/Helix

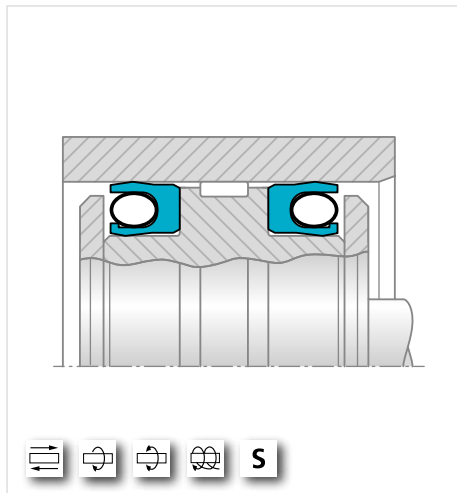

Turcon® VL Seal®

MATERIALS: Turcon®, Zurcon®, Elastomeric

The Turcon® VL Seal® is a single-acting L-shaped Turcon® seal with an elastic energizer for dynamic applications. Its design provides low friction, no stick-slip effect, high wear resistance. It features the Turcon® Stepseal® back pumping effect and is also available in Zurcon®. The seal can be installed in a standard O-Ring groove.

APPLICATIONS: hydraulics, general machine operation, machine tools, mobile hydraulics

Ø Range	Pressure Range	Temperature Range	Velocity
10 – 2,700 mm	60 MPa	-45 °C +200 °C	15 m/s
0.400 in – 105 in	8,700 psi	-49 °F +392 °F	50 ft/s

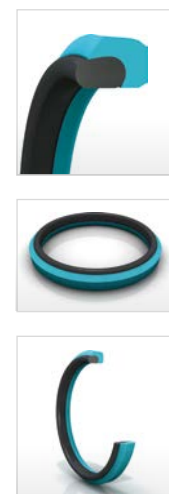
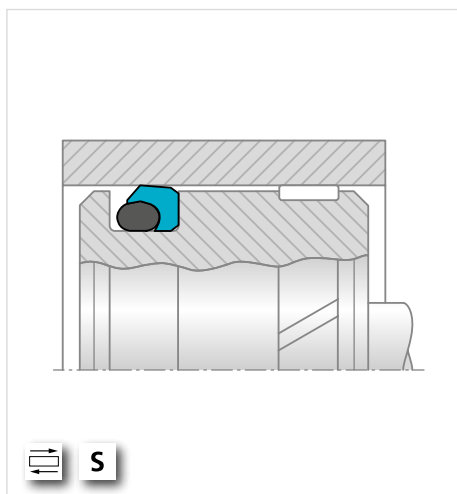

KEY TO APPLICATIONS: Reciprocating = Rotary = Oscillating = Helix = Static = Single-acting = S Double-acting = D



Hydraulic Seals – Rod Seals

For further literature, films, animations and mobile tools for rod seals, scan the QR-Code:

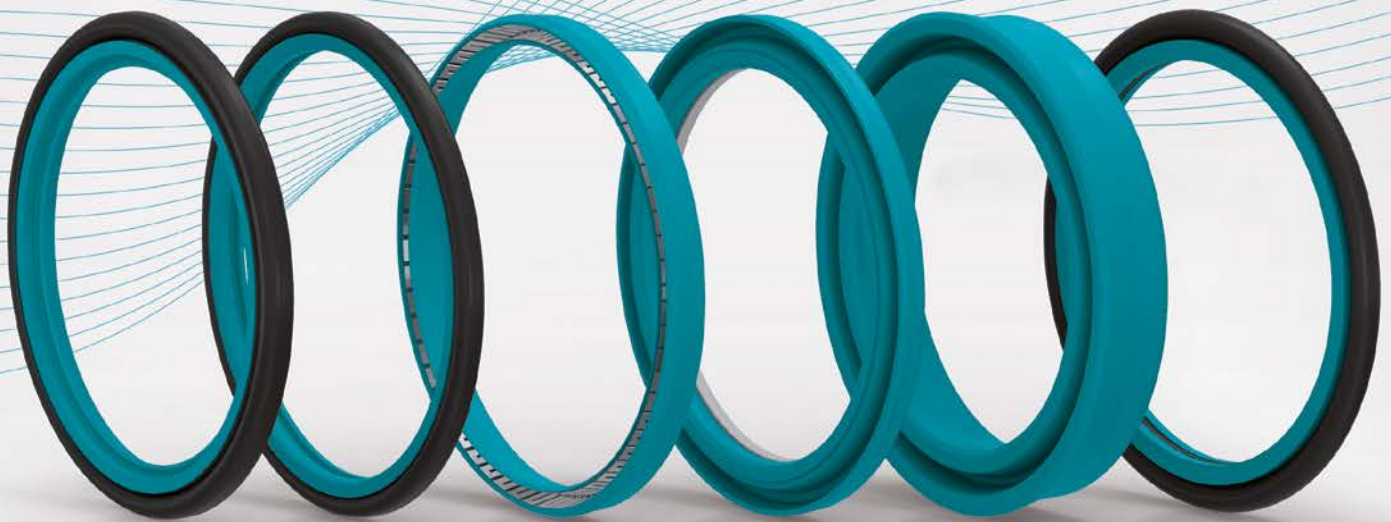

HYDRAULIC SYSTEM CALCULATOR



Our Hydraulic System Calculator helps you to calculate areas and volumes in the cylinder, extraction and retraction forces, time velocity and outflow.

For more information scan the QR-Code or visit our website: www.trelleborg.com/seals





Turcon® Stepseal® 2K

MATERIALS: Turcon®, Zurcon®, Elastomeric

A single-acting, O-Ring energized rod seal for dynamic applications, Turcon® Stepseal® 2K can be installed in closed grooves including grooves to ISO 7425. It offers high sealing efficiency, low friction with no stick-slip, minimal breakout force and high wear resistance. Optimum sealing characteristics are achieved by installing in a tandem Turcon® Stepseal® or Rimseal arrangement together with a double-acting scraper. Available in Turcon® or Zurcon® materials.

APPLICATIONS: hydraulics, general machine operation, machine tools, mobile hydraulics

Ø Range	Pressure Range	Temperature Range	Velocity
3 – 2,600 mm	60 MPa	-45 °C +200 °C	15 m/s
0.120 in – 102 in	8,700 psi	-49 °F +392 °F	50 ft/s

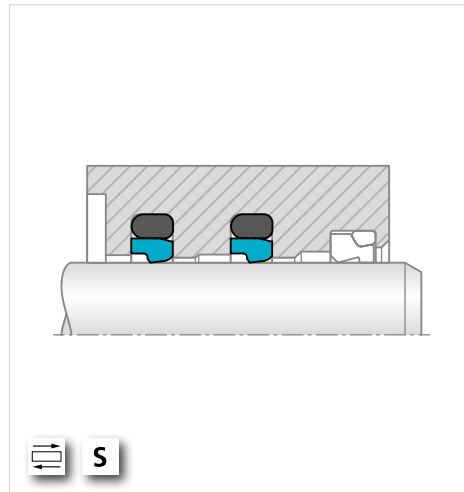

Turcon® Stepseal® V

MATERIALS: Turcon®, Zurcon®, Elastomeric

A single-acting, O-Ring energized rod seal with hydrostatic pressure relief channel for dynamic applications. Prevents pressure trap between seals under all service conditions. Installed in closed grooves including grooves to ISO 7425, Turcon® Stepseal® V offers high sealing efficiency. It also gives low friction with no stick-slip, minimal breakout force and high wear resistance.

APPLICATIONS: hydraulics, machine operation, machine tools, mobile hydraulics

Ø Range	Pressure Range	Temperature Range	Velocity
12 – 2,600 mm	60 MPa	-45 °C +200 °C	15 m/s
0.500 in – 102 in	8,700 psi	-49 °F +392 °F	50 ft/s

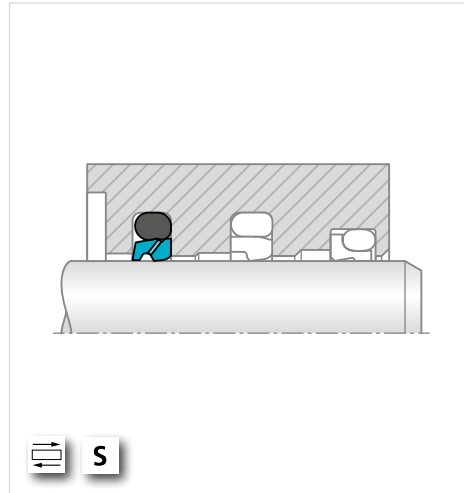

Turcon® Stepseal® 2A

MATERIALS: Turcon®, Zurcon®, Polyurethane, Elastomeric

Turcon® Stepseal® 2A has all of the excellent performance characteristics of Turcon® Stepseal® 2K with additional design features to protect against tilting as a result of back pressure.

APPLICATIONS: industrial hydraulics, mobile hydraulics, machine tools, hydraulic press, injection molding presses

Ø Range	Pressure Range	Temperature Range	Velocity
12 – 2,600 mm	60 MPa	-45 °C +200 °C	15 m/s
0.472 in – 102.4 in	8,700 psi	-49 °F +392 °F	50 ft/s

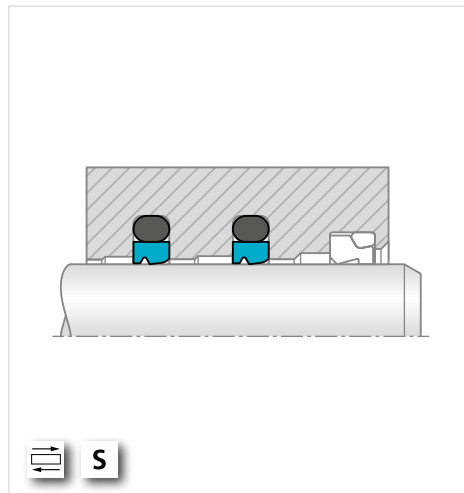

KEY TO APPLICATIONS: Reciprocating = Rotary = Oscillating = Helix = Static = Single-acting = **S** Double-acting = **D**



Turcon® Stepseal® 2A CR

MATERIALS: Turcon®, Zurcon®

Single-acting O-Ring energized rod seal with integrated back-up ring for higher pressure or bigger gaps for dynamic applications. High sealing efficiency, low friction with no stick-slip, minimal break out force and high wear resistance. Installation in the same grooves as Turcon® Stepseal® 2K and grooves according to ISO 7425-2.

APPLICATIONS: industrial hydraulics, mobile hydraulics, machine tools, hydraulic press, injection molding presses

Ø Range	Pressure Range	Temperature Range	Velocity
30 – 2,600 mm	100 MPa	-45 °C +200 °C	5 m/s
1.18 in – 102 in	14,500 psi	-49 °F +392 °F	16 ft/s

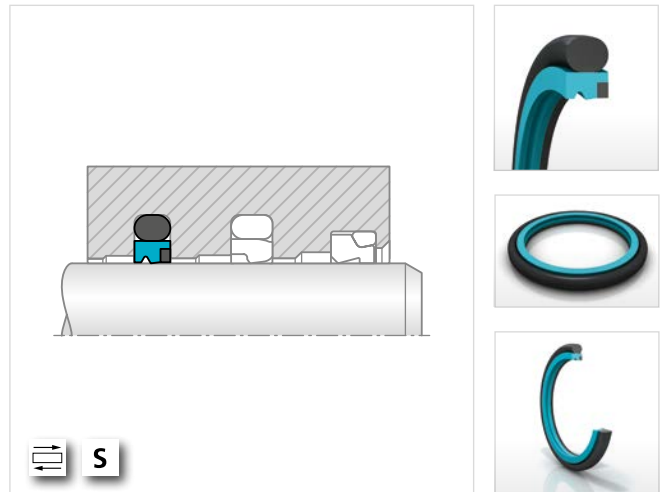

Turcon® VL Seal®

MATERIALS: Turcon®, Zurcon®, Elastomeric

A single-acting L-shaped Turcon® seal with an elastomer energizer for dynamic applications. The design provides low friction, no stick-slip, high wear resistance and features the Turcon® Stepseal® back pumping effect. Available in Turcon® and Zurcon® materials. Installed in standard O-Ring groove.

APPLICATIONS: hydraulics, general machine operation, machine tools, mobile hydraulics

Ø Range	Pressure Range	Temperature Range	Velocity
6 – 2,600 mm	60 MPa	-45 °C +200 °C	15 m/s
0.236 in – 102 in	8,700 psi	-49 °F +392 °F	50 ft/s

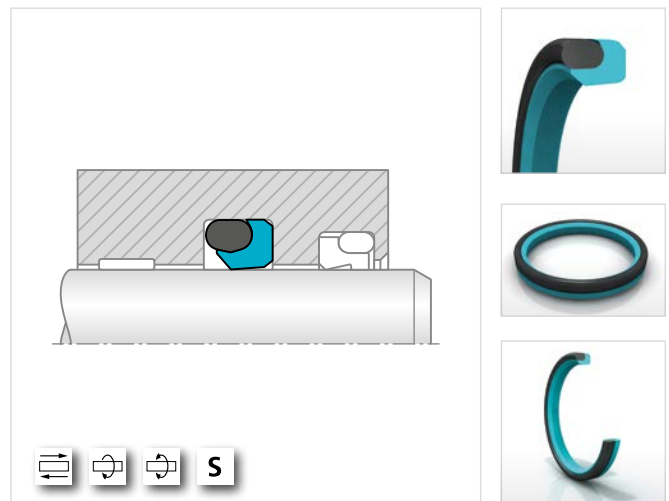

Turcon® VL Seal® II

MATERIALS: Turcon®, Zurcon®, Polyurethane

Turcon® VL Seal® II provides efficient sealing performance through high prestress and contact pressure against the rod surface and direct elastomer contact in the housing groove. The extended contact face with the O-Ring and the concave seal back, protects the O-Ring from damage by keeping it in position and limiting movement under all working conditions.

APPLICATIONS: Recip, Osc, Helix, Sing

Ø Range	Pressure Range	Temperature Range	Velocity
3 – 3,300 mm	35 MPa	-65 °C +200 °C	15 m/s
0.118 in – 130 in	5,500 psi	-85 °F +390 °F	50 ft/s

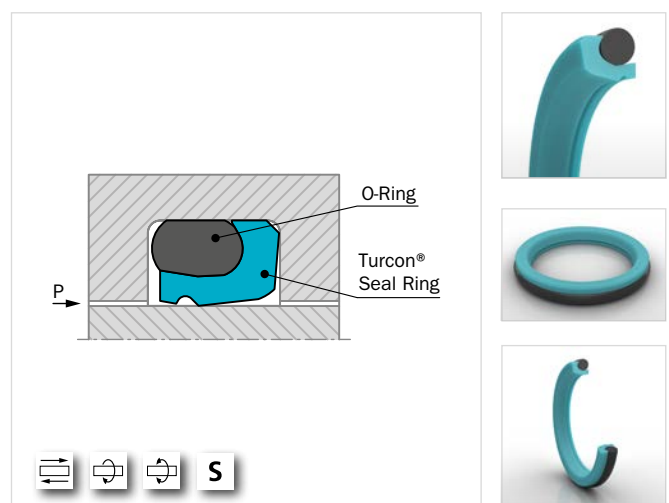

KEY TO APPLICATIONS: Reciprocating = Rotary = Oscillating = Helix = Static = Single-acting = **S** Double-acting = **D**



Zurcon® Rimseal

MATERIAL: Zurcon®, Elastomeric

Zurcon® Rimseal is a single-acting rod seal energized by an elastomer O-Ring with high static and dynamic tightness. Installation spaces are identical to those used for the Turcon® Stepseal® 2K, making Zurcon® Rimseal an ideal secondary system element. Applications include rod seals with redundant sealing systems and double wipers in mobile hydraulics, machine tools and injection molding machines.

APPLICATIONS: hydraulics, general machine operation, machine tools, mobile hydraulics

Ø Range	Pressure Range	Temperature Range	Velocity
8 – 2,200 mm	60 MPa (in tandem)	-45 °C +110 °C	5 m/s (in tandem)
0.315 in – 87 in	8,700 psi (in tandem)	-49 °F +230 °F	16 ft/s (in tandem)

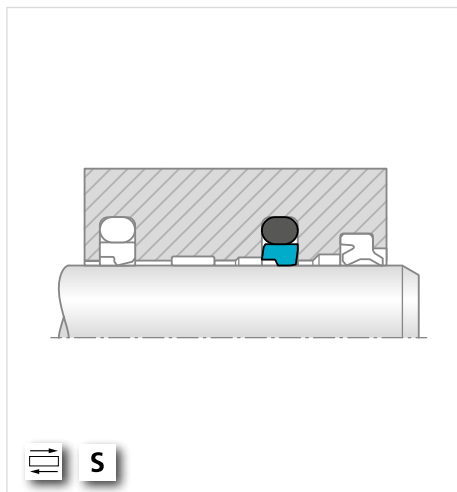

Zurcon® Rimseal IM

MATERIAL: Zurcon®, Elastomeric

Zurcon® Rimseal IM is a single-acting rod seal energized by an elastomer O-Ring with good static and dynamic tightness. It is optimized for injection molding technology and improves contact pressure distribution with improved back pumping and extrusion behavior. Installation grooves are identical to those used for Turcon® Stepseal® 2K, making Zurcon® Rimseal an ideal secondary seal. Zurcon® Z13 allows the seal to withstand higher temperatures and many hydraulic media.

APPLICATIONS: hydraulics, construction machinery, mobile hydraulics, machine tools

Ø Range	Pressure Range	Temperature Range	Velocity
8 – 999.9 mm	60 MPa (in tandem)	-45 °C +110 °C*	5 m/s (in tandem)
0.315 in – 39 in	8,700 psi (in tandem)	-49 °F +230 °F	16 ft/s (in tandem)

* Depending on O-Ring Energizer Low Temperature can decrease to -45°C (-50°F)

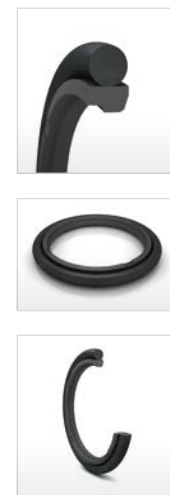
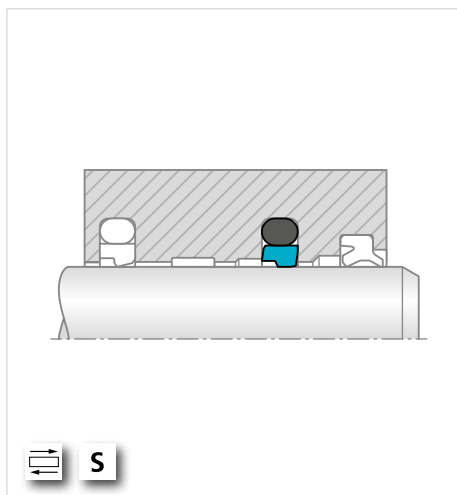

Zurcon® Buffer Seal

MATERIAL: Zurcon®

In heavy duty applications, leak-free performance and good service life cannot be assured by a single seal; therefore, specially developed system seals are arranged in series, building a tandem configuration. This innovative design incorporates large radius rounded edges on the seal ring and Back-up Ring that lower contact pressure, allowing a thicker amount of fluid to lubricate and activate the secondary seal.

APPLICATIONS: earth moving equipment, mobile hydraulics, construction machinery

Ø Range	Pressure Range	Temperature Range	Velocity
40 – 140 mm	40 MPa	-35 °C +110 °C	1 m/s
2 in – 8 in	5,800 psi	-31 °F +230 °F	3.2 ft/s

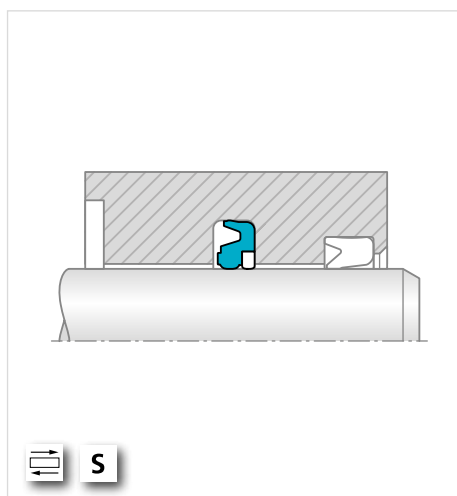

KEY TO APPLICATIONS: Reciprocating = Rotary = Oscillating = Helix = Static = Single-acting = **S** Double-acting = **D**



Zurcon® U-Cup RU9

MATERIAL: Zurcon®

Rod seals are particularly exposed to pressure and friction and a long service life is a specific requirement of piston rods. Zurcon® U-Cup RU9 can offer this with its outstanding wear and extrusion resistance. It is also compatible with virtually all media, has a wide operating temperature range, and gives low friction. It has compact installation dimensions, is easy to assemble and can be used as a stand alone element with limitation to 40 MPa or in a tandem system with pressure up to 50 MPa.

APPLICATIONS: hydraulic cylinder, mobile hydraulics, industrial hydraulics

Ø Range	Pressure Range	Temperature Range	Velocity
6 – 140 mm	40 MPa	-35 °C +110 °C	0.5 m/s
0.375 in – 8 in	5,800 psi	-31 °F +230 °F	1.6 ft/s

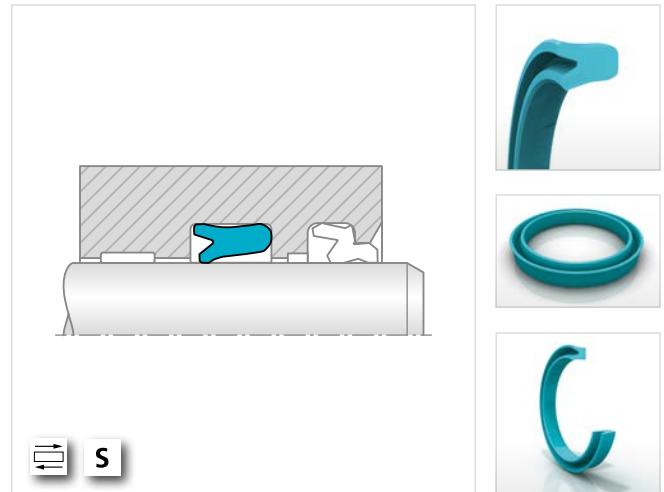

Zurcon® L-Cup

MATERIAL: Zurcon®

A single-acting rod seal, Zurcon® L-Cup is an alternative to the U-Cup. It is a highly effective sealing system offering optimized sealing performance and extended service life. With exceptionally low friction properties, it has high wear resistance, back pumping ability along with high static and dynamic tightness.

APPLICATIONS: hydraulics, standard cylinders

Ø Range	Pressure Range	Temperature Range	Velocity
16 – 195 mm	40 MPa	-35 °C +110 °C	0.5 m/s
0.629 in – 7.67 in	5,800 psi	-31 °F +230 °F	1.6 ft/s

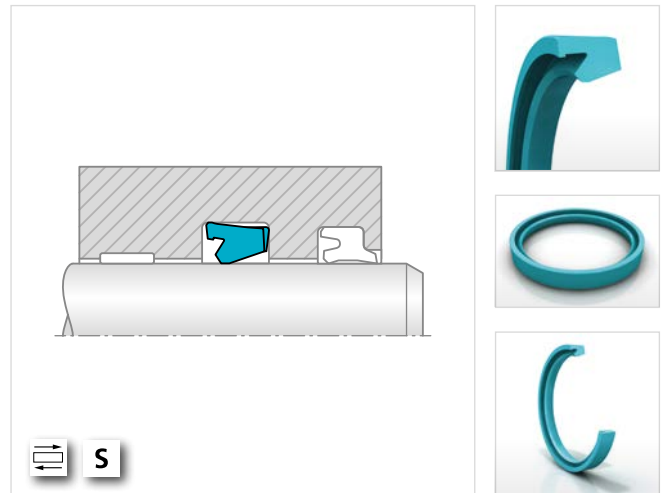

Turcon® Variseal® M2

MATERIALS: Turcon®, Zurcon®, Metal

A single-acting sealing element comprised of a U-shaped Turcon® ring and metallic energizing finger spring. It offers low friction with no stick-slip, minimal breakout force and high wear resistance. Resistant to most liquids and chemicals, it has unlimited shelf life.

APPLICATIONS: hydraulics, chemical industry, general mechanical applications, aggressive media, food and beverage

Ø Range	Pressure Range	Temperature Range	Velocity
3 – 3,300 mm	S: 40 MPa D: 20 MPa	-70 °C +300 °C	L: 15 m/s R/O/H: 1.3 m/s
0.118 in – 130 in	S: 5,800 psi D: 2,900 psi	-94 °F +572 °F	L: 50 ft/s R/O/H: 4.2 ft/s

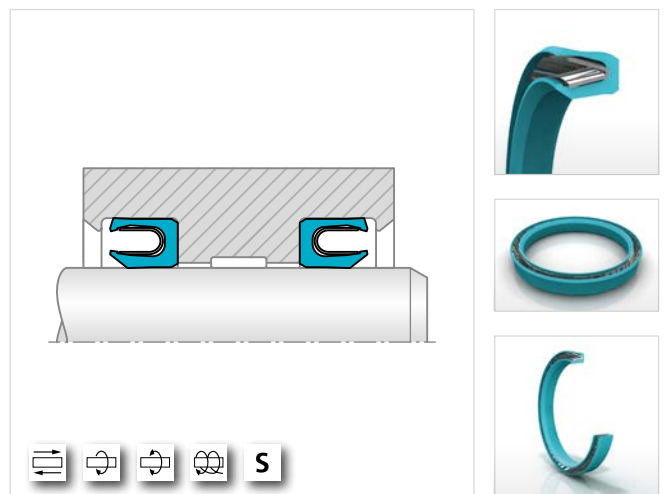

S = Static, D = Dynamic, L = Linear, R/O/H = Rotary/Oscillating/Helix

KEY TO APPLICATIONS: Reciprocating = Rotary = Oscillating = Helix = Static = Single-acting = **S** Double-acting = **D**



Turcon® Variseal® W2

MATERIALS: Turcon®, Zurcon®, Metal

Turcon® Variseal® W2 is a single-acting rod seal energized by a special Slantcoil® spring. The advantage of the Turcon® Variseal® W2 lies in its low friction and relatively constant preloading force over a relatively large deformation range. The seal is used wherever friction has to be kept within a narrow tolerance zone, for instance in pressure switches.

APPLICATIONS: chemical industry, general mechanical applications

Ø Range	Pressure Range	Temperature Range	Velocity
3 – 3,300 mm	S: 40 MPa D: 20 MPa	-70 °C +300 °C	L: 15 m/s R/O/H: 1.3 m/s
0.118 in – 130 in	S: 5,800 psi D: 2,900 psi	-94 °F +572 °F	L: 50 ft/s R/O/H: 4.2 ft/s

S = Static, D = Dynamic, L = Linear, R/O/H = Rotary/Oscillating/Helix

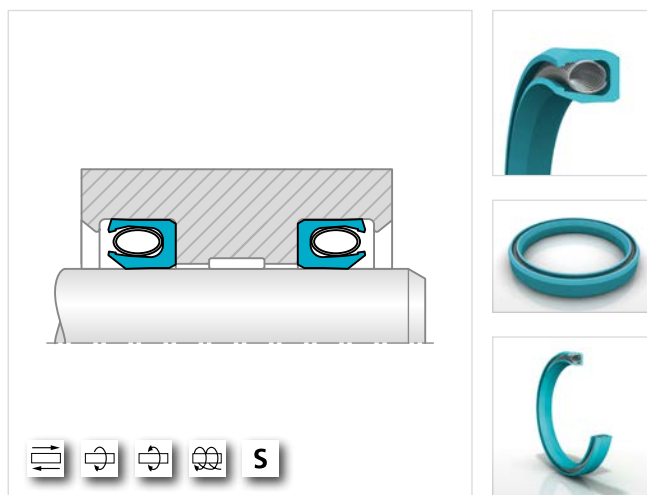

Turcon® Glyd Ring®

MATERIALS: Turcon®, Zurcon®, Elastomeric

Turcon® Glyd Ring® is a double-acting O-Ring energized rod seal for dynamic applications. It provides low friction with no stick-slip, minimal breakout force and high wear resistance. Installed in grooves to ISO 7425.

APPLICATIONS: hydraulics, general machine operation, machine tools, mobile hydraulics

Ø Range	Pressure Range	Temperature Range	Velocity
3 – 2,600 mm	60 MPa	-45 °C +200 °C	15 m/s
0.118 in – 102 in	8,700 psi	-49 °F +392 °F	50 ft/s

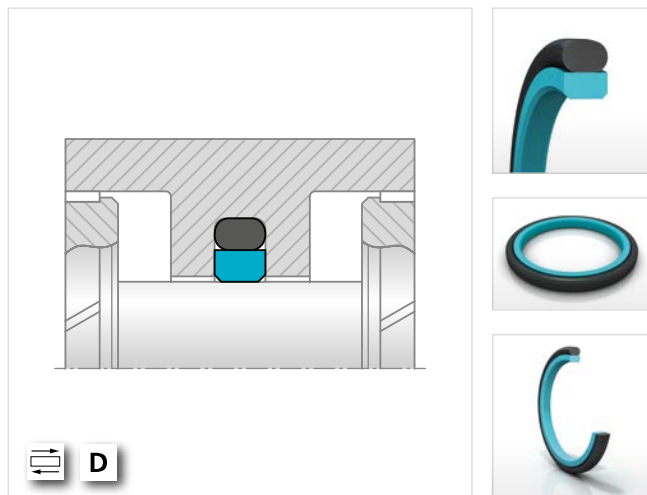

Turcon® Glyd Ring® T

MATERIALS: Turcon®, Zurcon®, Elastomeric

A further development of the Turcon® Glyd Ring® T provides improved leakage control and better resistance to extrusion. It is a double-acting O-Ring energized rod seal for dynamic applications that can be installed in grooves to ISO 7425. It offers low friction with no stick-slip, minimal breakout force and high wear resistance.

APPLICATIONS: hydraulics, general machine operation, machine tools, mobile hydraulics

Ø Range	Pressure Range	Temperature Range	Velocity
3 – 2,600 mm	60 MPa	-45 °C +200 °C	15 m/s
0.118 in – 102 in	8,700 psi	-49 °F +392 °F	50 ft/s

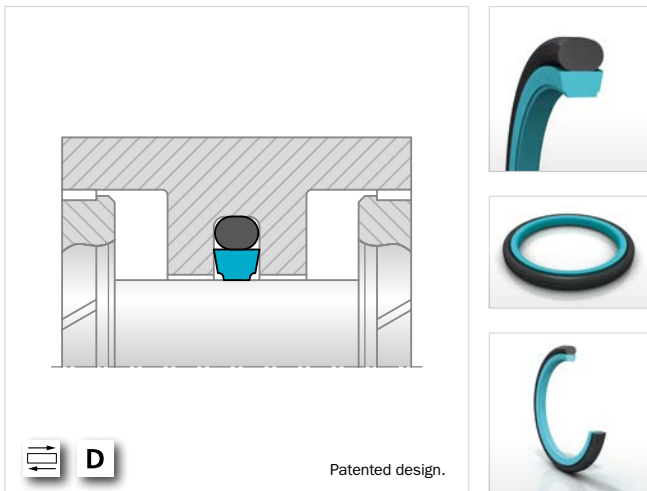

KEY TO APPLICATIONS: Reciprocating = Rotary = Oscillating = Helix = Static = Single-acting = **S** Double-acting = **D**



Turcon® AQ Seal® with Bean Seal

MATERIALS: Turcon®, Zurcon®, Elastomeric

A double-acting O-Ring energized seal developed for sealing between two media such as fluid and gas. It incorporates a limited footprint polyurethane Bean Seal inset into the dynamic sealing face. Installed in grooves to ISO 7425.

APPLICATIONS: hydraulics, general machine operation, fluid/gas separation, medium duty

Ø Range	Pressure Range	Temperature Range	Velocity
18 – 2,200 mm	50 MPa	-45 °C +110 °C	2 m/s
0.725 in – 87 in	7,250 psi	-49 °F +230 °F	6.5 ft/s

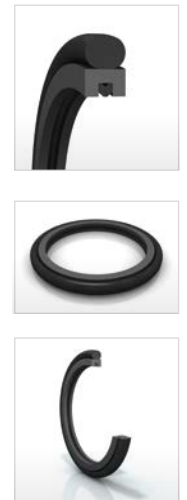
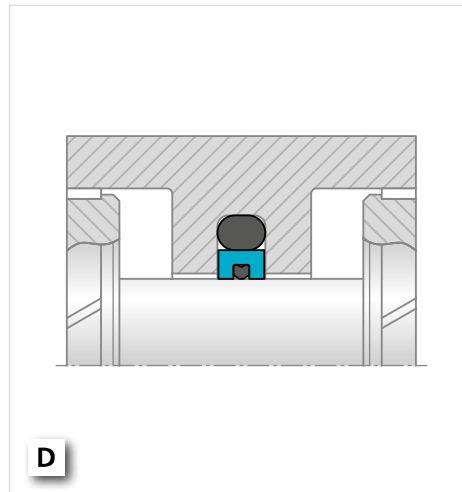

Turcon® AQ Seal® 5 with Bean Seal

MATERIALS: Turcon®, Zurcon®, Elastomeric

A further development of the standard Turcon® AQ Seal® double-acting seal with a polyurethane Bean Seal in the dynamic sealing face. It is energized by two O-Rings to improve sealing behavior.

APPLICATIONS: hydraulics, fluid/gas separation, mobile hydraulics, heavy operation

Ø Range	Pressure Range	Temperature Range	Velocity
32 – 2,200 mm	60 MPa	-45 °C +110 °C	3 m/s
1.275 in – 87 in	8,700 psi	-49 °F +230 °F	10 ft/s

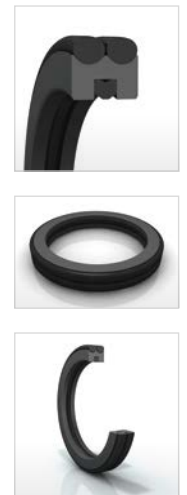
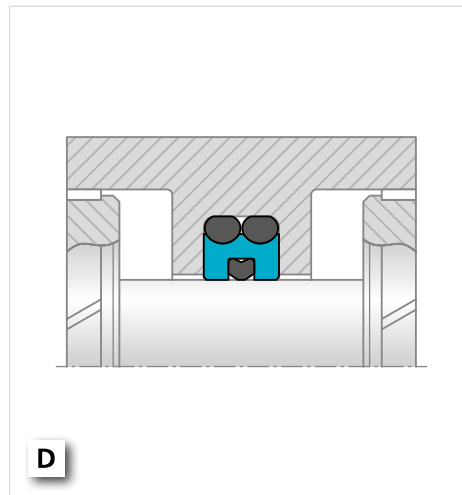

Zurcon® Wynseal M

MATERIALS: Turcon®, Zurcon®, Elastomeric

A double-acting O-Ring energized rod seal for dynamic applications in a machined version for all diameters up to 2,600 mm / 102 in. It can be installed in grooves to ISO 7425 and provides high sealing efficiency in tear and abrasion resistant Zurcon® polyurethane. Also available in Turcon® materials.

APPLICATIONS: hydraulics, light hydraulics, medium duty

Ø Range	Pressure Range	Temperature Range	Velocity
3 – 2,600 mm	50 MPa	-45 °C +200 °C	10 m/s
0.120 in – 102 in	7,250 psi	-49 °F +392 °F	33 ft/s

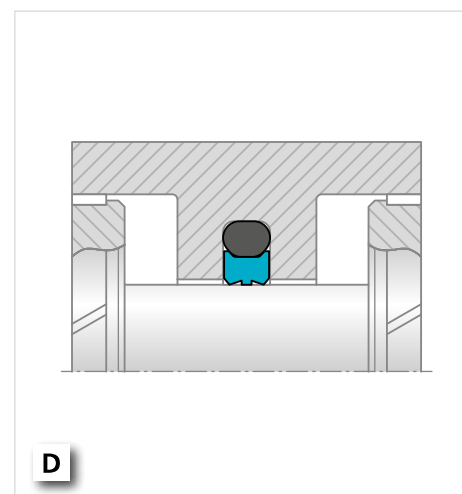

KEY TO APPLICATIONS: Reciprocating = Rotary = Oscillating = Helix = Static = Single-acting = **S** Double-acting = **D**



Turcon® Double Delta®

MATERIALS: Turcon®, Zurcon®, Elastomeric

The Turcon® Double Delta® is a double-acting sealing element which is energized by an elastomer O-Ring. The Turcon® Double Delta® seal can be fitted in existing O-Ring grooves (US standard AS 568 A, MIL-P-5514) and demonstrates good friction properties, stick-slip free starting and excellent dry running. The Turcon® Double Delta® is used in light and medium duty industrial hydraulics.

APPLICATIONS: hydraulics, light hydraulics, medium duty

Ø Range	Pressure Range	Temperature Range	Velocity
2 – 1,000 mm	35 MPa	-45 °C +200 °C	15 m/s
0.080 in – 39 in	5,000 psi	-49 °F +392 °F	50 ft/s

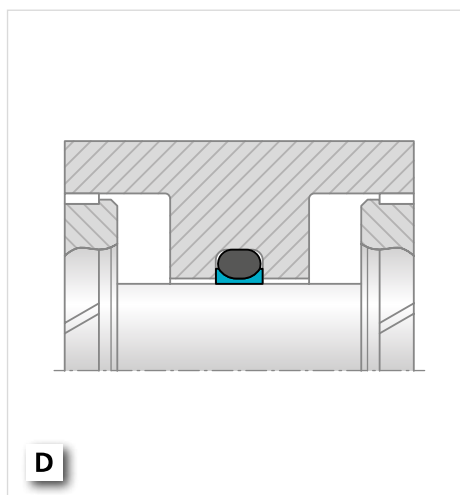

Turcon® V-Stack (Chevron Seal)

MATERIALS: Turcon®, Zurcon®

Turcon® V-Stack is a multi-element lip seal which provides high sealing efficiency due to a combination of seal elements.

APPLICATIONS: industrial hydraulics, oil and gas applications

Ø Range	Pressure Range	Temperature Range	Velocity
18 – 2,700 mm	140 MPa	-45 °C +260 °C	2 m/s
0.709 in – 106.3 in	20,000 psi	-49 °F +500 °F	6.5 ft/s

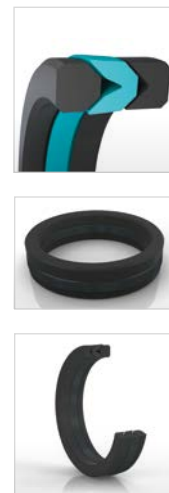
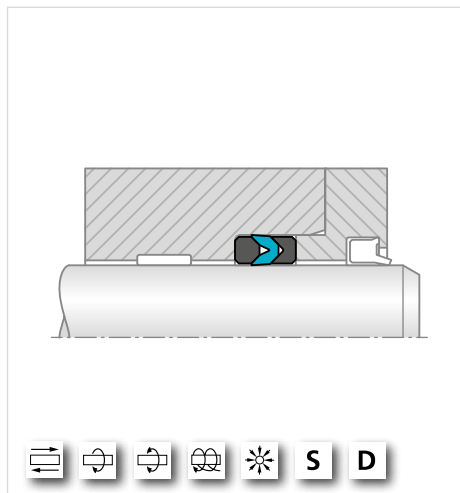

KEY TO APPLICATIONS: Reciprocating = Rotary = Oscillating = Helix = Static = Single-acting = **S** Double-acting = **D**



Hydraulic Scrapers

For further literature, films, animations and mobile tools for hydraulic scrapers, scan the QR-Code:



HYDRAULIC SYSTEM CALCULATOR



Our Hydraulic System Calculator helps you to calculate areas and volumes in the cylinder, extraction and retraction forces, time velocity and outflow.

For more information scan the QR-Code or visit our website: www.trelleborg.com/seals

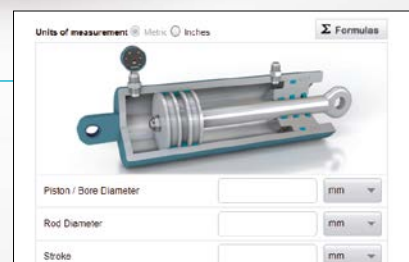



Turcon® Excluder® 2

MATERIALS: Turcon®, Zurcon®, Elastomeric

A double-acting O-Ring energized scraper that prevents the ingress of mud or other contaminants, increasing effective system service life. It has a secondary sealing capability for use with back pumping performance seals such as Turcon® Stepseal® 2K and Zurcon® Rimseal.

APPLICATIONS: light hydraulics, machine tools

Ø Range	Temperature Range	Velocity
4 – 2,600 mm	-45 °C +200 °C	15 m/s
0.157 in – 102 in	-49 °F +392 °F	50 ft/s

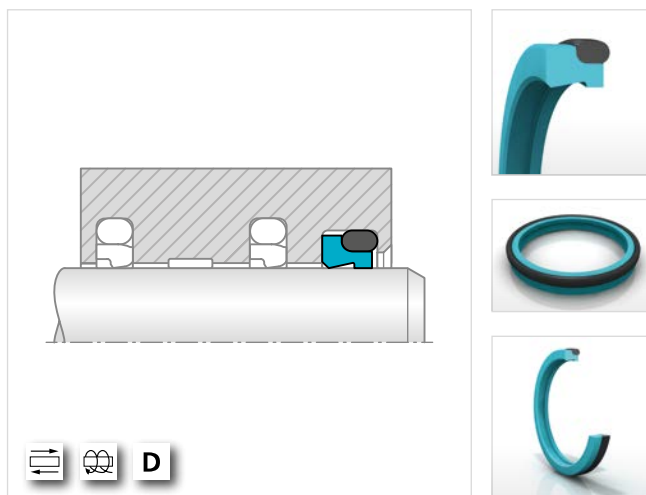

Turcon® Excluder® 5

MATERIALS: Turcon®, Zurcon®, Elastomeric

A double-acting O-Ring energized scraper which prevents the ingress of mud or other contaminants, increasing effective system service life. It has a secondary sealing capability for use with back pumping performance seals such as Turcon® Stepseal® 2K and Zurcon® Rimseal. It is ideal for heavy duty mobile hydraulics applications. Primarily available in Turcon® or Zurcon® materials.

APPLICATIONS: medium hydraulics, mobile hydraulics

Ø Range	Temperature Range	Velocity
20 – 2,600 mm	-45 °C +200 °C	15 m/s
0.787 in – 102 in	-49 °F +392 °F	50 ft/s

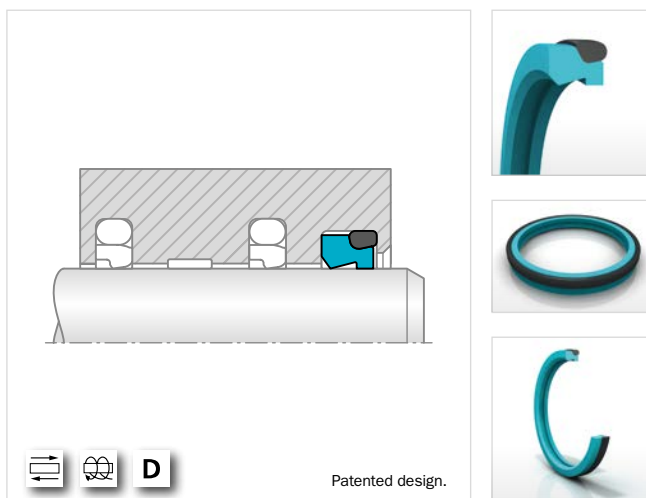

Patented design.



Turcon® Excluder® F

MATERIALS: Turcon®, Zurcon®, Elastomeric

Double-acting O-Ring energized scraper which prevents the ingress of mud or other contaminants to increase effective system service life. Used in light and medium duty industrial hydraulics. Offers easy installation in small diameters. Secondary sealing capability for use with back pumping performance seals such as Turcon® Stepseal® 2K and Zurcon® Rimseal. Available in Turcon® or Zurcon® materials.

APPLICATIONS: hydraulics, machine operation, machine tools, medium duty

Ø Range	Temperature Range	Velocity
19 – 1,500 mm	-45 °C +200 °C	15 m/s
0.750 in – 59 in	-49 °F +392 °F	50 ft/s

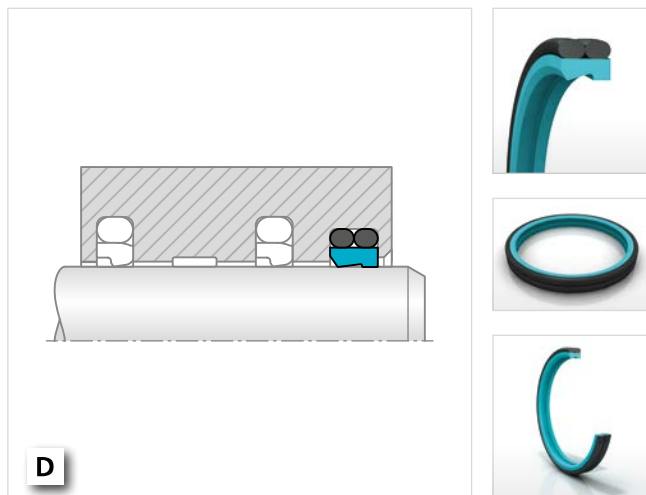

KEY TO APPLICATIONS: Reciprocating = Rotary = Oscillating = Helix = Static = Single-acting = S Double-acting = D



Turcon® Excluder® G

MATERIALS: Turcon®, Zurcon®, Elastomeric

Double-acting O-Ring energized scraper which prevents the ingress of contaminants to increase effective system service life in medium to heavy duty hydraulics. Advanced scraping lip prevents dirt from being trapped in front of the scraper element. Secondary sealing capability for use with back pumping performance seals such as Turcon® Stepseal® 2K and Zurcon® Rimseal. Available in Turcon® or Zurcon® materials.

APPLICATIONS: hydraulics, machine operation, mobile hydraulics, heavy duty

Ø Range	Temperature Range	Velocity
100 – 1,500 mm	-45 °C +200 °C	5 m/s
4 in – 59 in	-49 °F +392 °F	16 ft/s

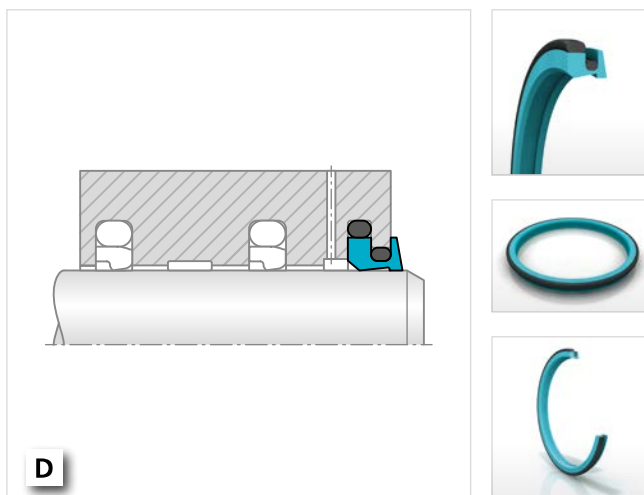

Turcon® Excluder® S

MATERIALS: Turcon®, Zurcon®, Elastomeric, Metal

Turcon® Excluder® S is a double-acting O-Ring energized scraper for linear dynamic applications for installation in open grooves. Turcon® Excluder® S has a V-Spring activated scraping lip for optimal scraping effect.

APPLICATIONS: mining equipment, hydraulic presses, steelworks, heavy construction machinery, marine constructions, offshore installations, water works

Ø Range	Pressure Range	Temperature Range	Velocity
16 – 2,600 mm	1.5 MPa	-60 °C* up to +200 °C*	up to 5 m/s*
–	217.5 psi	-76 °F* up to +392 °F*	up to 16 ft/s*

* Dependant on material

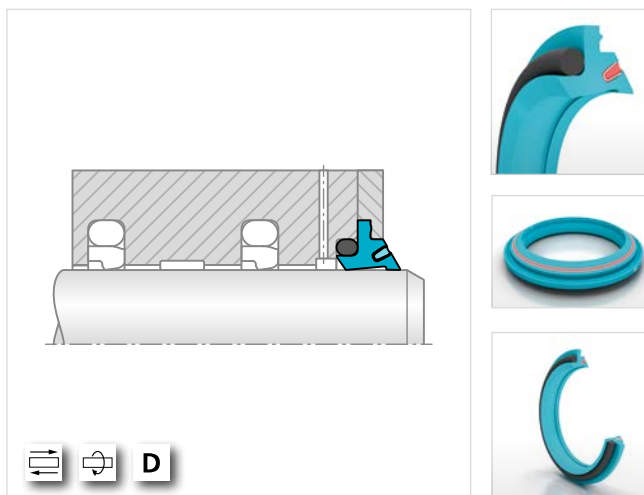

Turcon® Excluder® SN (Notch)

MATERIALS: Turcon®, Zurcon®, Elastomeric, Metal

Turcon® Excluder® SN is a double-acting O-Ring energized scraper for linear dynamic applications for installation in open grooves. Turcon® Excluder® SN has a V-Spring activated scraping lip for optimal scraping effect and the internal sealing lip has an axial notch for relieving the pressure under the scraping lip.

APPLICATIONS: mining equipment, hydraulic presses, steelworks, heavy construction machinery, marine constructions, offshore installations, water works

Ø Range	Pressure Range	Temperature Range	Velocity
16 – 2,600 mm	1.5 MPa	-60 °C* up to +200 °C*	up to 5 m/s*
–	217.5 psi	-76 °F* up to +392 °F*	up to 16 ft/s*

* Dependant on material

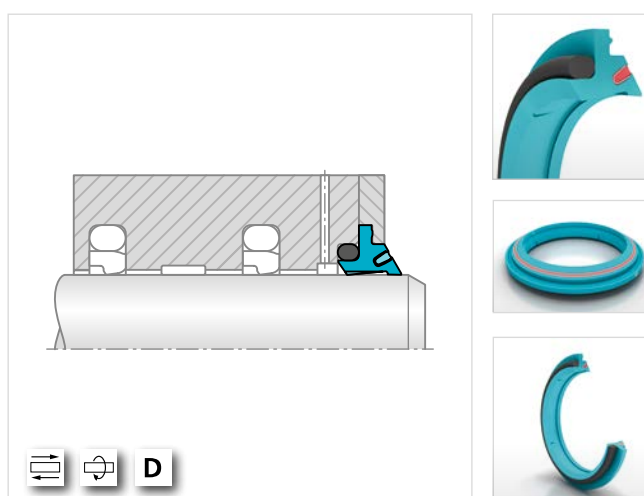

KEY TO APPLICATIONS: Reciprocating = Rotary = Oscillating = Helix = Static = Single-acting = S Double-acting = D



Turcon® Excluder® SR (2 x O-Ring)

MATERIALS: Turcon®, Zurcon®, Elastomeric

Turcon® Excluder® SR is a double-acting O-Ring energized scraper for linear dynamic applications for installation in open grooves. Turcon® Excluder® SR has an O-Ring activated scraping lip for optimal scraping effect.

APPLICATIONS: mining equipment, hydraulic presses, steelworks, heavy construction machinery, marine constructions, offshore installations, water works

Ø Range	Pressure Range	Temperature Range	Velocity
16 – 2,600 mm	1.5 MPa	-60 °C* up to +200 °C*	up to 5 m/s*
–	217.5 psi	-76 °F* up to +392 °F*	up to 16 ft/s*

* Dependant on material

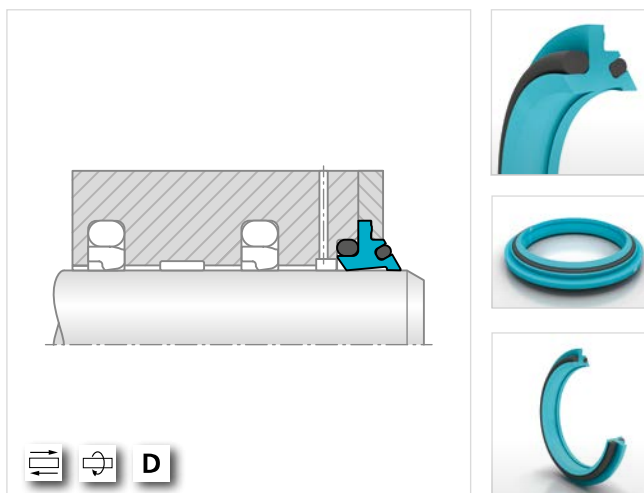

Turcon® Variseal® M2S

MATERIALS: Turcon®, Zurcon®, Metal

A single-acting sealing element comprised of a U-shaped Turcon® ring and metallic energizing finger spring. It offers low friction with no stick-slip, minimal breakout force and high wear resistance. Effective as a scraper and resistant to most liquids and chemicals.

APPLICATIONS: marine and subsea, scraping marine growth, high temperature, low temperature and cryogenic, high speed hydraulics in dirty environments

Maximum Pressure MPA (psi)	Material	Temperature Range*	Velocity
Dynamic: 20 (2,900)	T40	-50 °C to +260 °C	Reciprocating up to 15 m/s
	T40 (HiClean)	-45 °C to +260 °C	Rotating up to 1.27 m/s
Static: 40 (5,800)**	Z80	-50 °C to +80 °C	Reciprocating up to 2 m/s

* -196 °C possible with custom designs ** 207 MPa (30,000 psi) possible with custom designs

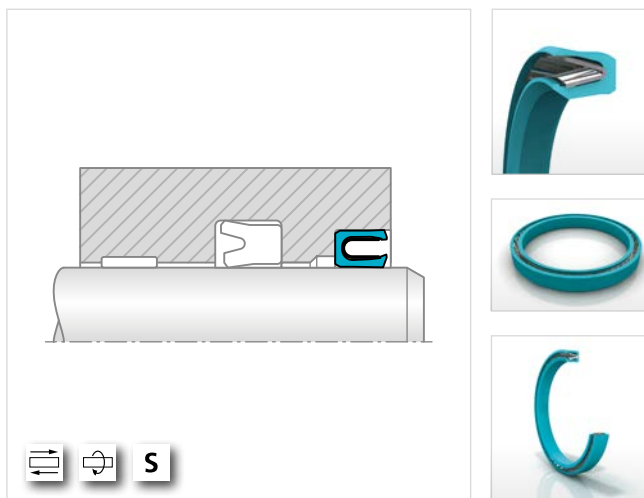

Zurcon® Excluder® Z

MATERIAL: Zurcon®, Elastomeric

A double-acting O-Ring energized scraper which prevents the ingress of contaminants, increasing system service life in heavy duty mobile hydraulics applications. It has a secondary sealing capability for use with back pumping performance seals such as Zurcon® RU9 and Zurcon® Rimseal IM. The design is optimized for injection molding technology and guarantees increased scraping and sealing due to optimized rod contact force distribution. It is ideal for heavy duty mobile hydraulics applications.

APPLICATIONS: hydraulics, construction machinery, mobile hydraulic, truck cranes

Ø Range	Temperature Range	Velocity
Designs available from 12 mm – 400 mm	-30 °C to +110 °C*	Up to 2 m/s
–	-22 °F to +230 °F	6.5 ft/s

* Depending on O-Ring Energizer Low Temperature can decrease to -45°C (-50°F)

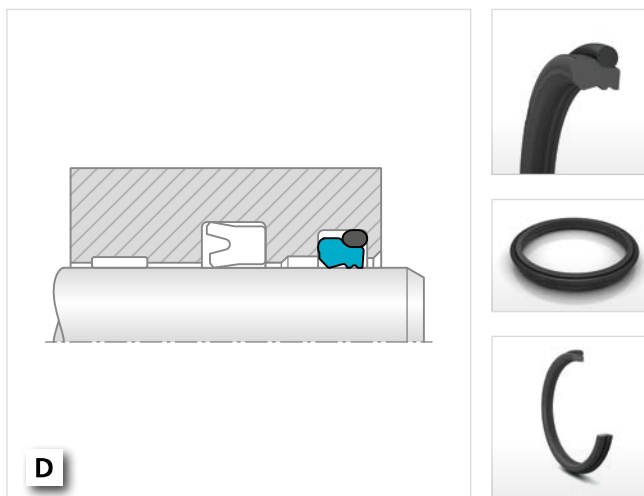

KEY TO APPLICATIONS: Reciprocating = Rotary = Oscillating = Helix = Static = Single-acting = S Double-acting = D



Zurcon® Scraper DA22

MATERIAL: Zurcon®

A double-acting scraper with a sealing and scraping lip in injection molded polyurethane that can be installed in grooves to ISO 6195 type C. For applications in conjunction with seals that give back pumping performance, such as Turcon® Stepseal® 2K and Zurcon® Rimseal.

APPLICATIONS: hydraulics, general purpose, industrial hydraulics, ISO 6195 housing

Ø Range	Temperature Range	Velocity
5 – 180 mm	-35 °C +100 °C	1 m/s
0.197 in – 7 in	-31 °F +212 °F	3 ft/s

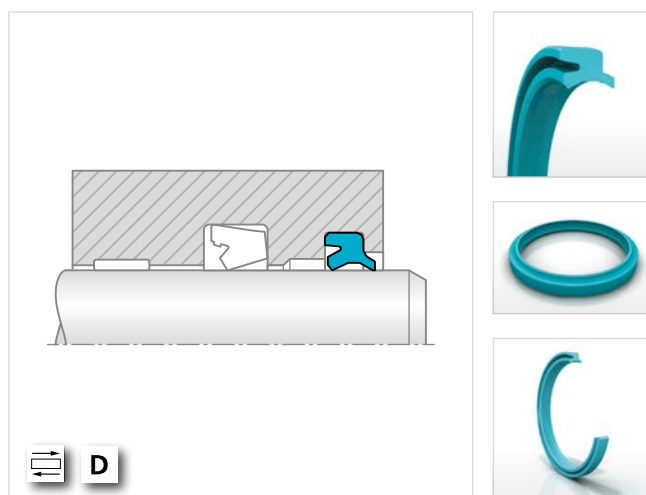

Zurcon® Scraper DA24

MATERIAL: Zurcon®

The Zurcon® Scraper DA24 is a double-acting polyurethane scraper for severe operating conditions and heavy dirt attack. It is especially suitable for construction machinery and mobile hydraulics. It can be used where there is side pressure on the piston rod.

APPLICATIONS: hydraulics, mobile hydraulics

Ø Range	Temperature Range	Velocity
45 – 290 mm	-35 °C +100 °C	1 m/s
1.6 in – 11 in	-31 °F +212 °F	3 ft/s

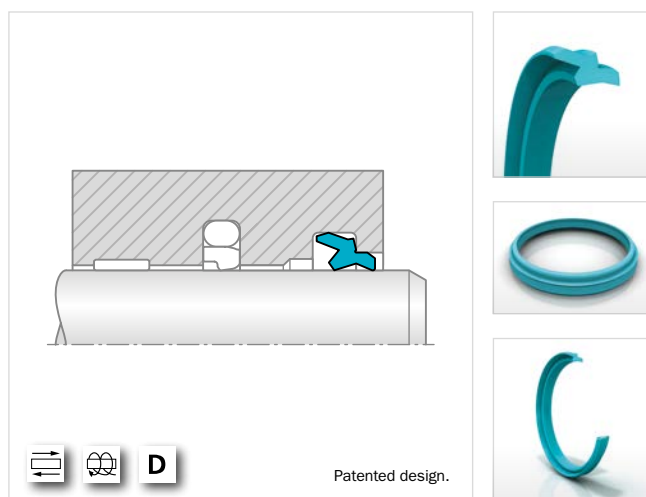

Zurcon® Scraper DA24 Venting

MATERIAL: Zurcon®

Zurcon® Scraper DA24 is a new double-acting thermoplastic polyurethane scraper design for severe operating conditions and heavily contaminated environments, enhancing overall performance. Axial holes through the section operate as pressure relief valves, allowing oil to be released in the case of overpressure without any risk of dirt ingress.

APPLICATIONS: construction machinery, agriculture and forestry machinery, mobile hydraulics, high attack of dirt, side steering of piston rod

Ø Range	Max. Pressure MPa (psi)	Temperature Range	Velocity
–	Standard: 5 (725)	-35 °C +100 °C	Up to 1 m/s
–	Venting: 2 (290)	-31 °F +212 °F	3 ft/s*

* At high strokes and higher speed, please contact your local Customer Solution Center.

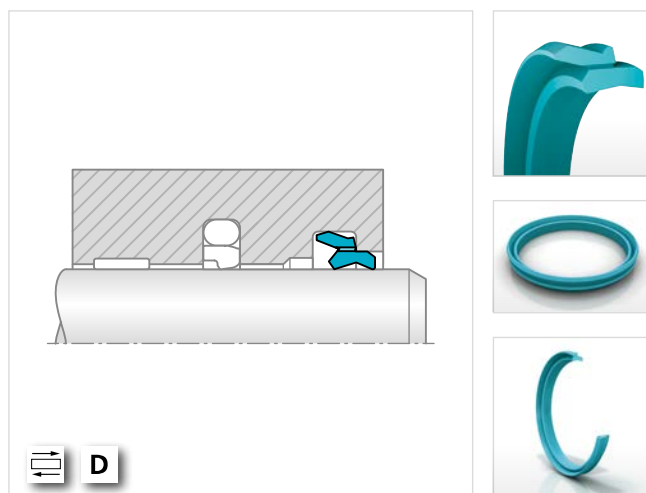

KEY TO APPLICATIONS: Reciprocating = Rotary = Oscillating = Helix = Static = Single-acting = S Double-acting = D



Zurcon® Scraper DA17

MATERIAL: Elastomeric

A double-acting scraper with both a sealing and a scraping lip in NBR. For applications in conjunction with seals that give back pumping performance, such as Turcon® Stepseal® 2K and Zurcon® Rimseal.

APPLICATIONS: hydraulics, general purpose

Ø Range	Temperature Range	Velocity
10 – 440 mm	-25 °C +100 °C	1 m/s
0.394 in – 17 in	-13 °F +212 °F	3 ft/s

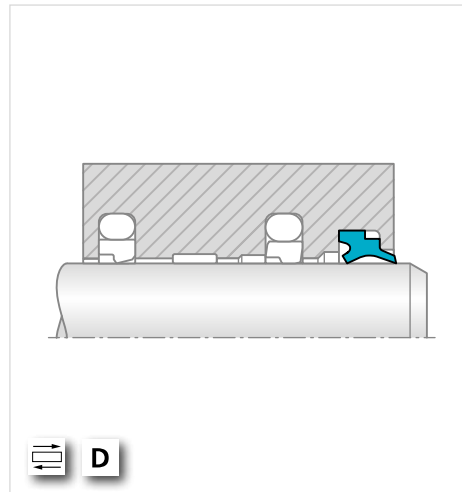

Zurcon® Scraper DA27

MATERIAL: Elastomeric

The double-acting rubber Zurcon® Scraper DA27 is designed for large diameter hydraulic applications. With its "heavy" cross section it is a natural extension of scraper DA17 for diameters over 400 mm / 15.75 in. The DA27 scraper is produced by vulcanizing the required diameter from a 600 mm / 24 in master mold.

APPLICATIONS: hydraulics, industrial hydraulics, presses

Ø Range	Temperature Range	Velocity
400 – 2,600 mm	-30 °C +100 °C	1 m/s
15.75 in – 102 in	-22 °F +212 °F	3 ft/s

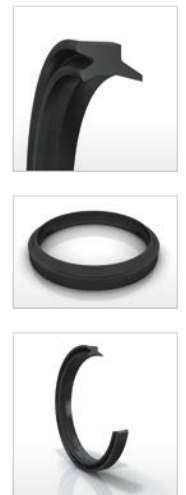
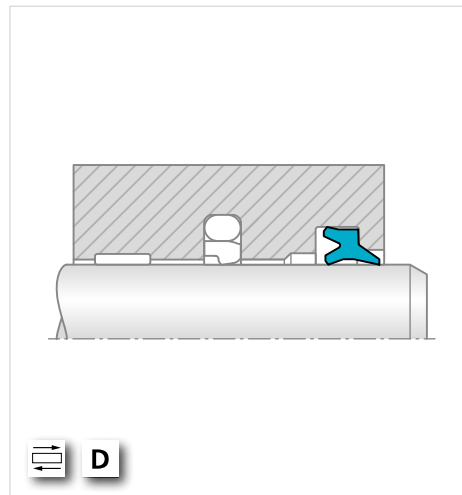

Zurcon® Scraper ASW

MATERIAL: Zurcon®

Injection molded polyurethane scraper with one scraping lip and inner support bead that gives improved seating in the groove. It has good abrasion and tear resistance.

APPLICATIONS: hydraulics, general purpose

Ø Range	Temperature Range	Velocity
8 – 125 mm	-35 °C +100 °C	1 m/s
0.315 in – 5 in	-31 °F +212 °F	3 ft/s

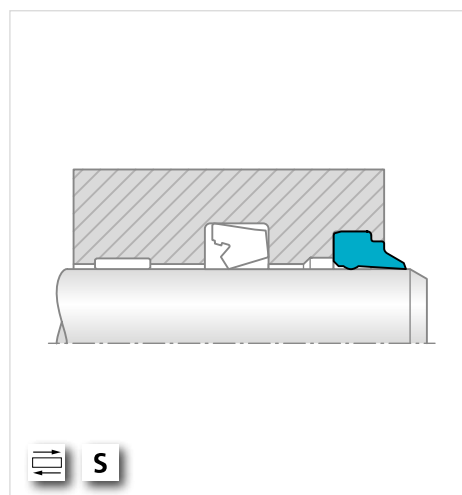

KEY TO APPLICATIONS: Reciprocating = Rotary = Oscillating = Helix = Static = Single-acting = **S** Double-acting = **D**



Zurcon® Scraper WAE

MATERIALS: Zurcon®, Polyurethane

The Zurcon® Scraper WAE is a single-acting polyurethane scraper. The special feature of this scraper is an additional support on the inner surface. It prevents tilting or twisting of the scraper. At the same time this support improves seating in the groove, preventing the ingress of contaminants via the back of the scraper. This represents a technical improvement compared to similar scraper types.

APPLICATIONS: industrial hydraulics, mobile hydraulics

Ø Range	Temperature Range	Velocity
18 – 2,600 mm	-35 °C +100 °C	1 m/s
0.500 in – 102.4 in	-31 °F +212 °F	3 ft/s

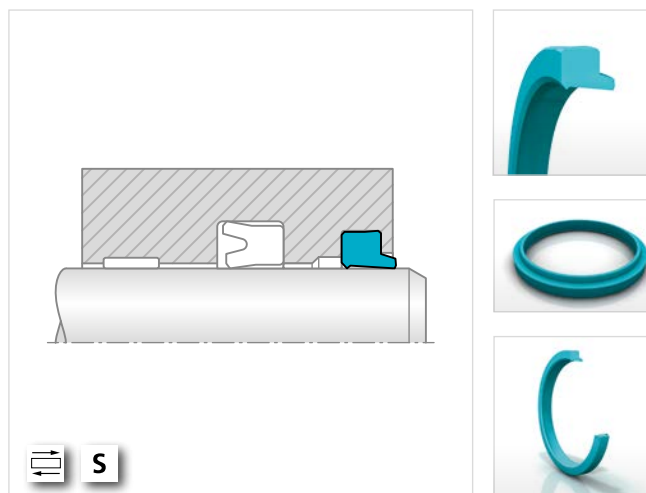

Zurcon® Heavy Duty Scraper WAE

MATERIAL: Zurcon®

Zurcon® Heavy Duty Scraper WAE provides improved scraping performance under heavy contaminated environments. Represents a technical improvement compared to the standard double-acting WAE scraper.

APPLICATIONS: construction machinery, mobile hydraulic equipment, vertical mounted cylinders, agriculture machinery, forestry machinery

Ø Range	Pressure Range	Temperature Range	Velocity
19 – 1524 mm	5.5 MPa	-60 °C +130 °C	2 m/s
0.750 in – 60 in	800 psi	-76 °F +266 °F	6.5 ft/s

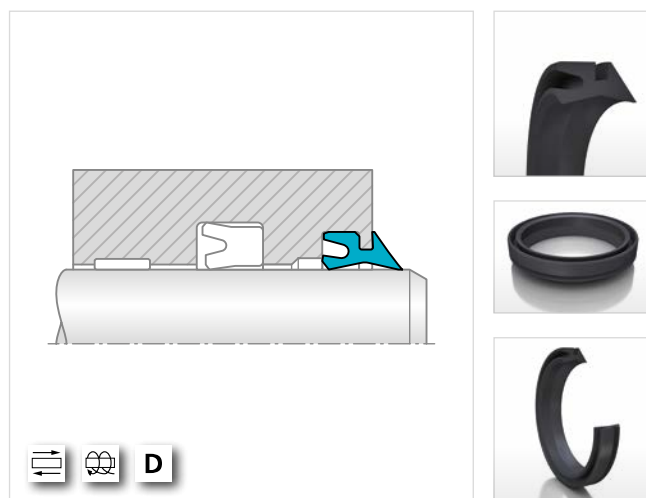

Zurcon® Scraper WNV

MATERIAL: Zurcon®

Zurcon® Scraper WNV is a double-acting scraper. Its dynamic scraping lip is specially designed with an additional inward sealing edge to keep the residual oil film in the system. If the volume of this oil film can not be back pumped by the main rod seal, a pressure build-up will be prevented by lifting the scraper lip to reduce pressure. The static sealing lip and edge ensure against ingress of dirt and fluids.

APPLICATIONS: agricultural machinery, mobile hydraulics, ISO standard cylinders

Ø Range	Temperature Range	Velocity
16 – 100 mm	-35 °C +100 °C	1 m/s
0.625 in – 4 in	-31 °F +212 °F	3 ft/s

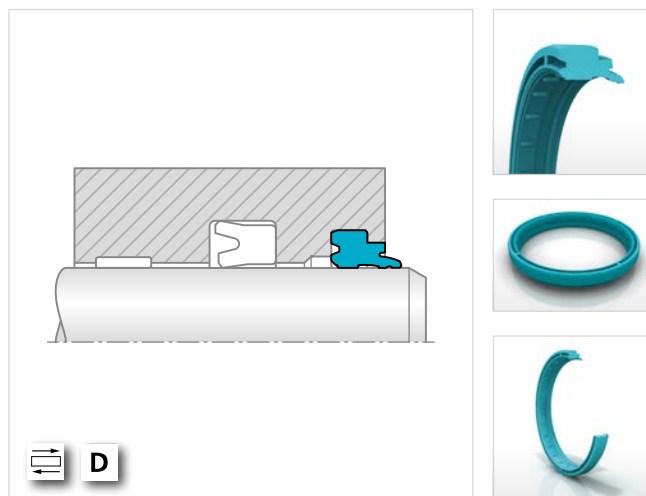

KEY TO APPLICATIONS: Reciprocating = Rotary = Oscillating = Helix = Static = Single-acting = **S** Double-acting = **D**



Scraper WRM

MATERIAL: Elastomeric

Scraper WRM is a single-acting, heat-molded elastomer scraper. It possesses a comb profile sealing surface on its outer diameter which guarantees a firm seat in the groove. It is easy to install in closed grooves.

APPLICATIONS: hydraulics, general purpose

Ø Range	Temperature Range	Velocity
12 – 260 mm	-30 °C +110 °C	1 m/s
0.472 in – 10.25 in	-22 °F +230 °F	3 ft/s

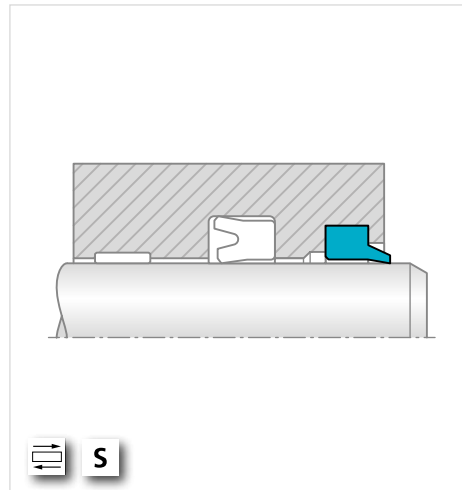

Zurcon® Scraper SWP

MATERIAL: Zurcon®, Metal

A single-acting Zurcon® scraper encased in a steel carrier, Zurcon® Scraper SWP gives excellent wear resistance and is easily installed into open grooves. The scraper is recommended for mobile hydraulic applications and as a rotary link pin seal.

APPLICATIONS: mobile hydraulics, construction machinery, link pin sealing

Ø Range	Temperature Range	Velocity
25 – 190 mm	-35 °C +100 °C	1 m/s
1 in – 7.5 in	-31 °F +212 °F	3 ft/s

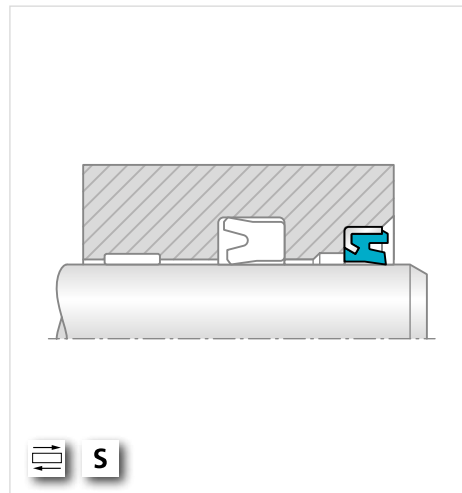

Scraper WSA

MATERIALS: Elastomeric, Metal

Metal caged scraper with an NBR lip. For installation in open grooves including grooves to ISO 6195 Type B. This scraper is also available in FKM.

APPLICATIONS: hydraulics, general purpose

Ø Range	Temperature Range	Velocity
6 – 280 mm	-30 °C +200 °C	1 m/s
0.236 in – 11 in	-22 °F +230 °F	3 ft/s

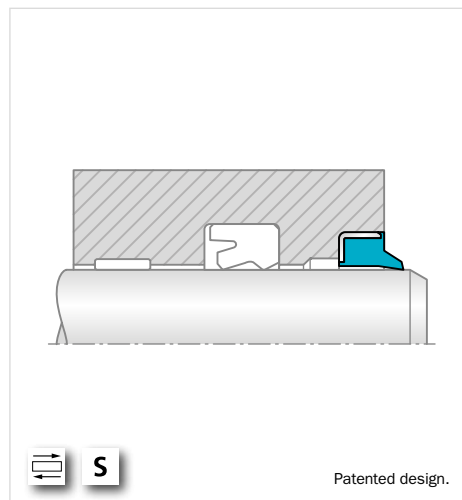

KEY TO APPLICATIONS: Reciprocating = Rotary = Oscillating = Helix = Static = Single-acting = **S** Double-acting = **D**



Metal Scraper

MATERIALS: Elastomeric, Metal, Brass

Metal scraper consists of a thin spring brass scraper lip in tandem with an NBR wiping lip encased in a steel shell. It is capable of removing dried or frozen mud, tar, ice and other contaminants from the rod. Also available in stainless steel with an FKM wiper lip.

APPLICATIONS: hydraulics, general purpose

Ø Range	Temperature Range	Velocity
12 – 400 mm	-40 °C +200 °C	1 m/s
0.472 in – 15.75 in	-40 °F +392 °F	3 ft/s

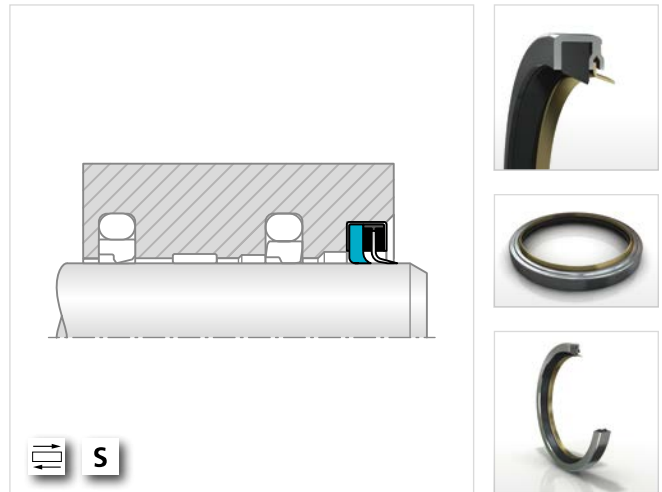

KEY TO APPLICATIONS: Reciprocating = Rotary = Oscillating = Helix = Static = Single-acting = **S** Double-acting = **D**

! This page is intentionally left blank.



Hydraulic Wear Rings

For further literature, films, animations and mobile tools for hydraulic wear rings, scan the QR-Code:



HYDRAULIC SYSTEM CALCULATOR



Our Hydraulic System Calculator helps you to calculate areas and volumes in the cylinder, extraction and retraction forces, time velocity and outflow.

For more information scan the QR-Code or visit our website: www.trelleborg.com/seals

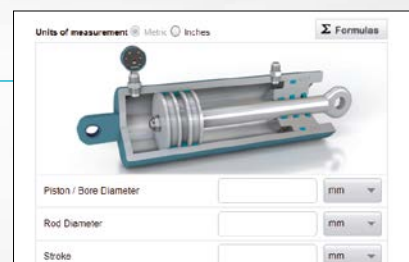



Turcite® Slydring®

MATERIAL: Turcite®

Turcite® Slydring® prevents metal-to-metal contact between piston / rod and bore / gland, absorbing transverse loads. Turcite® material gives good load capacity with low friction and stick-slip-free operation. The Slydring® protects critical sealing lips from contamination and dieseling effects. Cost-effective, it allows designers freedom in hardware material selection. Higher static loads are permissible.

APPLICATIONS: hydraulics, general purpose, standard cylinders

Ø Range	Radial Bearing Pressure	Temperature Range	Velocity
8 – 2,200 mm	15 MPa	-60 °C +200 °C	15 m/s
0.315 in – 86 in	2,200 psi	-76 °F +392 °F	50 ft/s

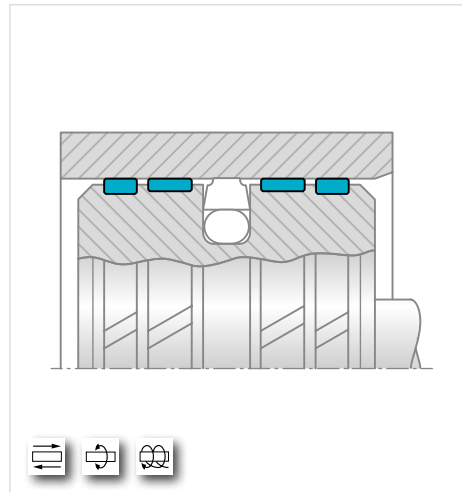

HiMod® Slydring®

MATERIAL: HiMod®

HiMod® Slydring® prevents metal-to-metal contact between piston / rod and bore / gland, absorbing transverse loads. The modified polymeric material provides an economical solution for applications with medium transverse loads, while giving good wear and compression properties. The Slydring® is easily installed by snap-fitting and offers good dry running and wiping performance. Higher static loads are permissible.

APPLICATIONS: hydraulics, general purpose, standard cylinders, mobile hydraulics

Ø Range	Radial Bearing Pressure	Temperature Range	Velocity
8 – 915 mm	50 MPa*	-40 °C +135 °C**	1 m/s
0.315 in – 36 in	7,200 psi*	-40 °F +275 °F**	3 ft/s

* dependent on material and temperature
 ** dependent on material

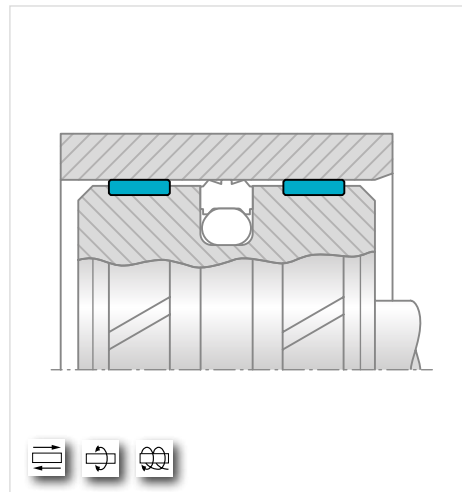

Orkot® Slydring®

MATERIAL: Orkot®

Orkot® Slydring® prevents metal-to-metal contact between piston / rod and bore / gland, absorbing high transverse loads. Orkot® is a resin-impregnated, fine weave fabric material with added lubricants, preventing stick-slip. It is capable of withstanding high side loads, damping vibrations and embedded foreign particles. Higher static loads are permissible. Special materials are available with operating temperatures up to +250 °C / +482 °F.

APPLICATIONS: hydraulics, general purpose, standard cylinders, mobile hydraulics

Ø Range	Radial Bearing Pressure	Temperature Range	Velocity
8 – 1,500 mm	100 MPa*	-40 °C +120 °C	1 m/s
0.315 in – 59 in	14,500 psi*	-40 °F +248 °F	3 ft/s

* dependent on pressure, speed, material and temperature

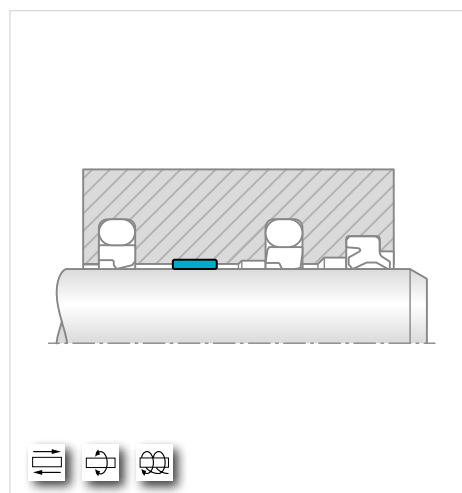

KEY TO APPLICATIONS: Reciprocating = Rotary = Oscillating = Helix = Static = Single-acting = **S** Double-acting = **D**



Static Seals

For further literature, films, animations and mobile tools for static seals, scan the QR-Code:

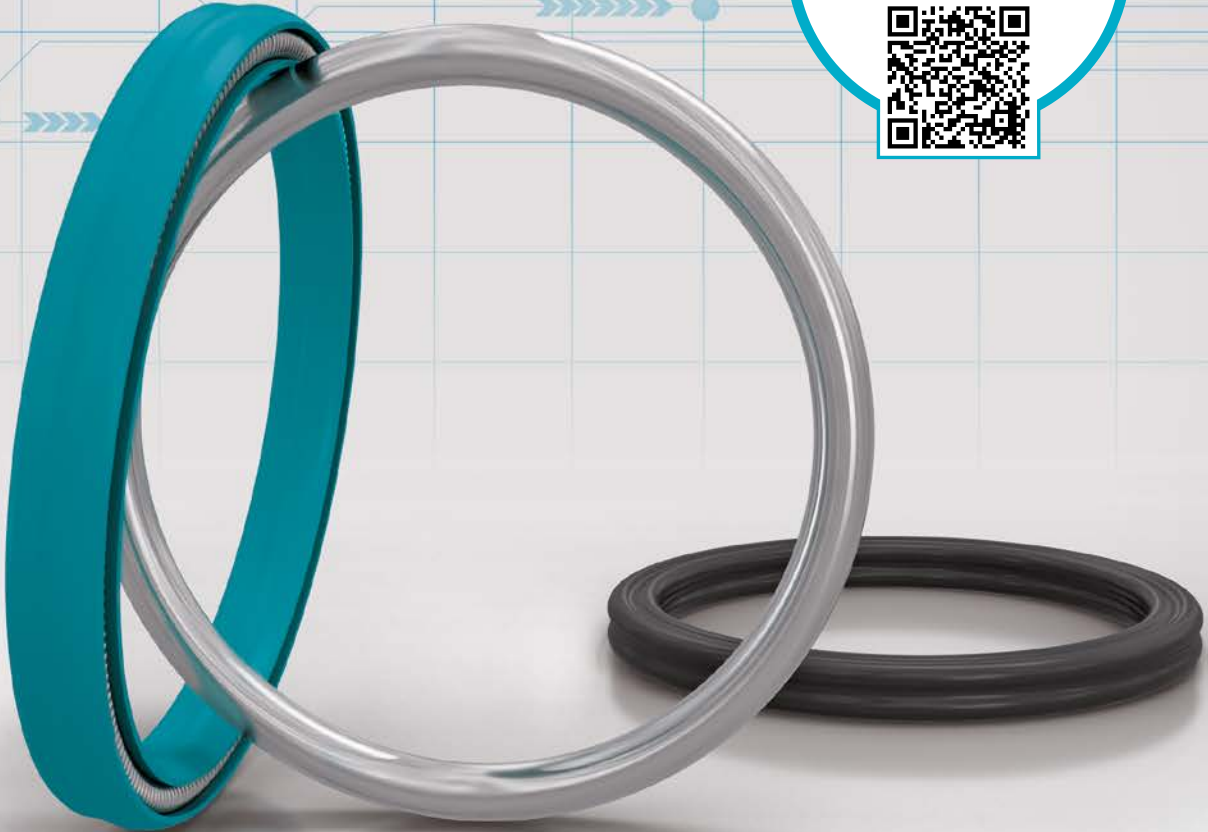



Zurcon® Dualseal

MATERIAL: Zurcon®

Zurcon® Dualseal is a sealing element for static applications and a highly effective alternative to an O-Ring and Back-up Ring combination. The main advantages are resistance to twisting, stability at pulsating pressures and low contamination risk. Zurcon® Dualseal is easy to install and guarantees long service life. Recommended for heavy duty applications in cylinders and valves.

APPLICATIONS: mobile hydraulics, twist-free

Ø Range	Pressure Range	Temperature Range	Velocity
6 – 280 mm	50 MPa	-35 °C +110 °C	–
0.236 in – 11 in	7,250 psi	-31 °F +230 °F	–

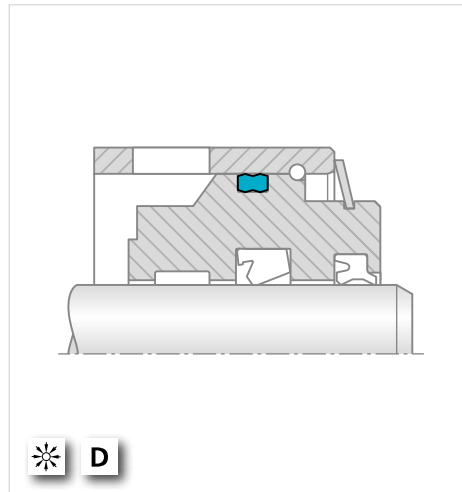

☼ D



Elastomeric Dualseal

MATERIAL: Elastomeric

Developed to address fluid power industry requirements, the Elastomeric Dualseal is a one-piece alternative to O-Rings and Back-up Rings for static sealing. As a single component, it can easily retrofit existing standard ISO 3601-1/AS 568 O-Ring groove sizes and provides improved performance in most applications.

APPLICATIONS: mobile hydraulics, resistant to twisting

Ø Range	Pressure Range	Temperature Range	Velocity
2 – 658 mm	0 – 21 MPa	-30 °C +100 °C	–
0.070 in – 26 in	0 – 3,000 psi	-22 °F +212 °F	–

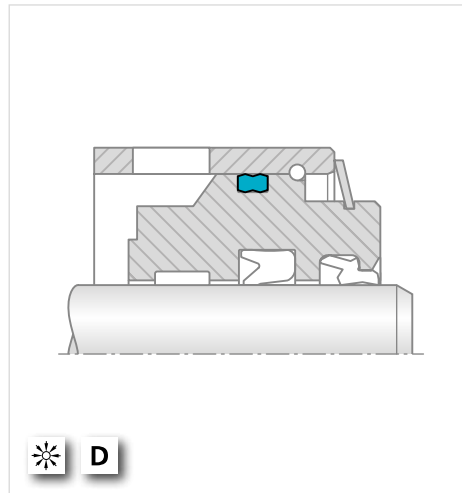

☼ D



Quad-Ring® / X-Ring

MATERIAL: Elastomeric

A double-acting four lip seal for static and dynamic applications. Available in a wide range of elastomer compounds. Provides higher seal efficiency and lower friction than conventional O-Rings.

APPLICATIONS: general purpose, twist-free

Ø Range	Pressure Range	Temperature Range	Velocity
1 – 660 mm	40 MPa	-30 °C +200 °C	0.5 m/s (up to 2 m/s rotary)
0.039 in – 26 in	5,800 psi	-22 °F +392 °F	1.6 ft/s (up to 6.5 ft/s rotary)

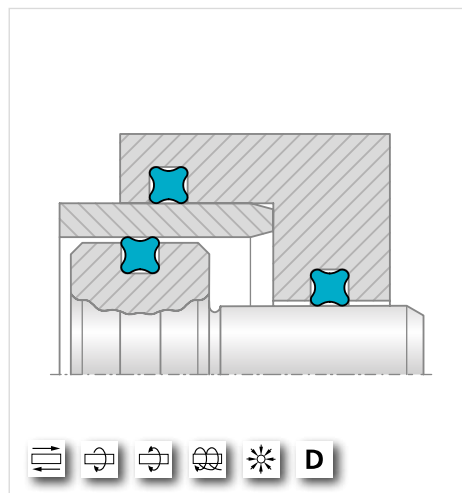

⇄ ⇌ ⚙ ☼ D

KEY TO APPLICATIONS: Reciprocating = ⇄ Rotary = ⇌ Oscillating = ⚙ Helix = ⚙ Static = ☼ Single-acting = S Double-acting = D



Kantseal

MATERIAL: Elastomeric

Kantseal is an elastomer square sectioned ring for static applications. Mostly used on flanges to SAE standards and covers, it has a high sealing efficiency and keeps its shape. Available in nitrile (NBR) and fluorocarbon (FKM).

APPLICATIONS: general purpose for flanges, axial static

Ø Range	Pressure Range	Temperature Range	Velocity
5 – 456 mm	50 MPa	-30 °C +200 °C	–
0.197 in – 18 in	7,250 psi	-22 °F +392 °F	–

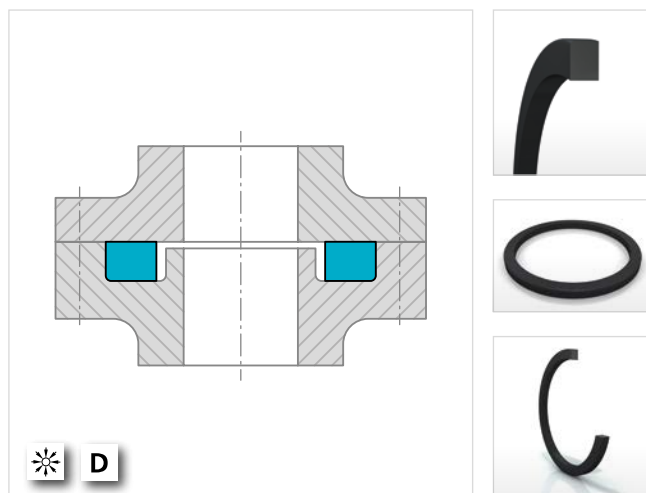

Back-up Ring

MATERIALS: Turcon®, Zurcon®, HiMod®, PTFE, Elastomeric, Polyurethane, Other Polymeric

Back-up Rings are installed together with O-Rings and Quad-Ring® / X-Rings to prevent gap extrusion in applications above 5 MPa / 725 psi. Available in spiral, cut or uncut designs in filled or unfilled PTFE, Turcon®, elastomers and thermoplastics based on ISO 3601, AS 568.

APPLICATIONS: general purpose for O-Ring and Quad-Ring® / X-Rings

Ø Range	Pressure Range	Temperature Range	Velocity
from 2.9 mm	250 MPa	-200 °C +260 °C	0.5 m/s
from 0.115 in	36,250 psi	-328 °F +500 °F	1.6 ft/s

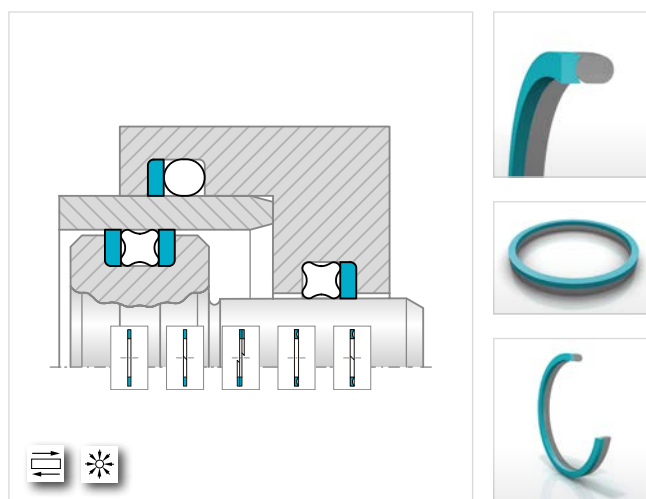

Wills Rings® O

MATERIAL: Metal

Wills Rings® O are metal O-Rings for static face-sealing applications that give reliable performance over a large temperature range for gases and liquids. Extreme high pressures and vacuums can be sealed with Wills Rings® O giving long life and excellent corrosion resistance. Available as pressure-filled, pressure-actuated, non-pressurized and solid seals, in mild and stainless steel, copper and Inconel® 600 materials.

APPLICATIONS: general purpose sealing, extreme conditions, flange applications

Ø Range	Pressure Range	Temperature Range	Velocity
8 – 3,000 mm	1,000 MPa	up to +850 °C	–
0.315 in – 118 in	145,000 psi	up to +1,562 °F	–

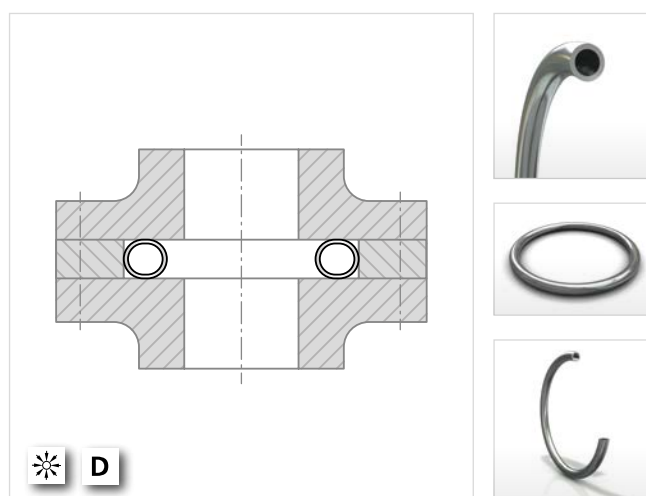

KEY TO APPLICATIONS: Reciprocating = Rotary = Oscillating = Helix = Static = Single-acting = **S** Double-acting = **D**



Wills Rings® C

MATERIAL: Metal

Wills Rings® C are metal C-Rings used for almost any static face sealing application. They give reliable performance over a large temperature range in liquids and can also seal high pressures and vacuums. Wills Rings® C exhibits greater spring back and elasticity than Wills Rings® O. This characteristic provides more effective sealing where thermal expansion of the seal housing is found.

APPLICATIONS: general purpose sealing, extreme conditions, flange applications

Ø Range	Pressure Range	Temperature Range	Velocity
20 – 500 mm	200 MPa	up to +750 °C	–
0.787 in – 19.5 in	29,000 psi	up to +1,382 °F	–

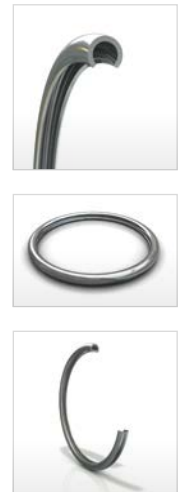
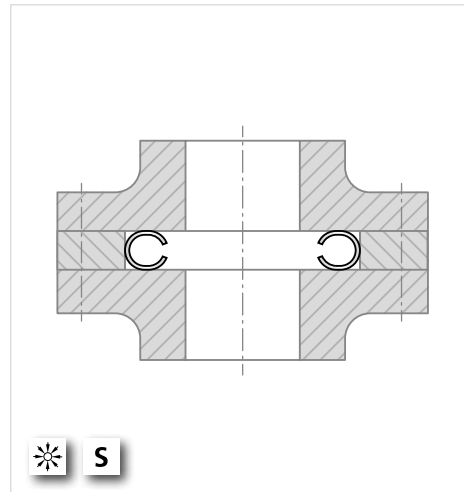

Turcon® Variseal® H

MATERIALS: Turcon®, Zurcon®, Metal

A single-acting sealing element comprised of a U-shaped Turcon® ring and a coiled metallic energizing spring. The seal has a high specific sealing force and gives gas-tight sealing even at low temperatures. Resistant to most liquids and chemicals it has unlimited shelf life. Used for radial static or slightly dynamic applications, the seal is available in versions for cryogenic service.

APPLICATIONS: chemical industry, gasket fittings, gas sealing

Ø Range	Pressure Range	Temperature Range	Velocity
3 – 3,300 mm	40 MPa	-100 °C +200 °C	–
0.118 in – 130 in	5,800 psi	-148 °F +392 °F	–

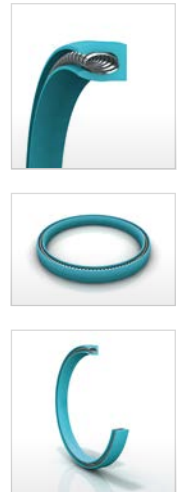
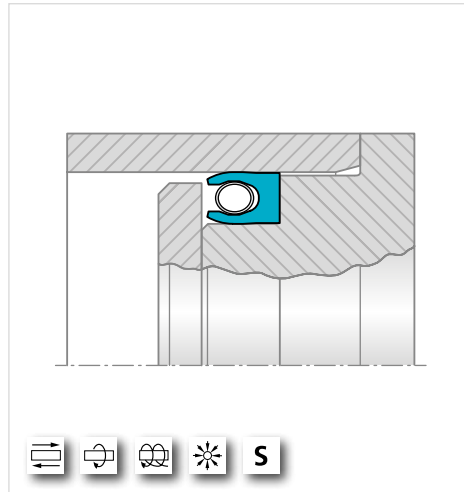

Turcon® Variseal® HF

MATERIALS: Turcon®, Zurcon®, Metal

A single-acting face sealing element comprised of a U-shaped Turcon® ring and a coiled metallic energizing spring. The seal has a high specific sealing force and gives gas-tight sealing even at low temperatures. Resistant to most liquids and chemicals it has unlimited shelf life. Used for inside or outside sealing, the seal is available in versions for cryogenic service.

APPLICATIONS: chemical industry, flange fittings, gas sealing

Ø Range	Pressure Range	Temperature Range	Velocity
3 – 3,300 mm	60 MPa	-150 °C +200 °C	–
0.118 in – 130 in	8,700 psi	-238 °F +392 °F	–

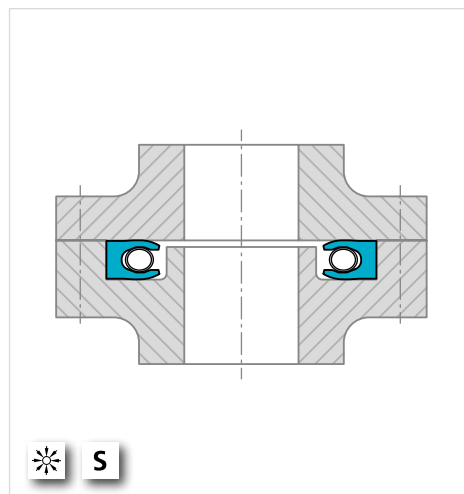

KEY TO APPLICATIONS: Reciprocating = Rotary = Oscillating = Helix = Static = Single-acting = **S** Double-acting = **D**



Metal End Cap (MEC) Seal

MATERIALS: Elastomeric, Metal

Elastomer chemically bonded onto 2 steel caps. This provides high level of extrusion resistance.

APPLICATIONS: oil and gas wellhead, tubing and casing hanger

Ø Range	Pressure Range	Temperature Range	Velocity
50 – 600 mm	100 MPa	-20 °C +177 °C	–
1.969 in – 23.622 in	15,000 psi	-4 °F +350 °F	–

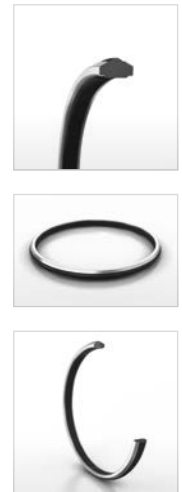
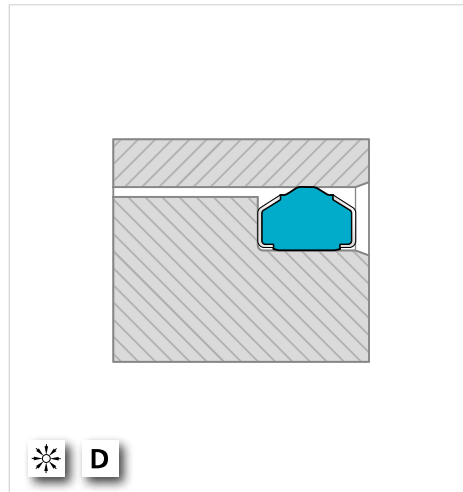

XploR™ S-Seal

MATERIALS: Elastomeric, Metal

Profiled elastomer seal with 2 intergral anti-extrusion springs.

APPLICATIONS: oil and gas wellhead, tubing and casing hanger

Ø Range	Pressure Range	Temperature Range	Velocity
50 – 600 mm	103.4 MPa	-20 °C to +200 °C	–
1.969 in – 23.62 in	15,000 psi	-4 °F to +392 °F	–

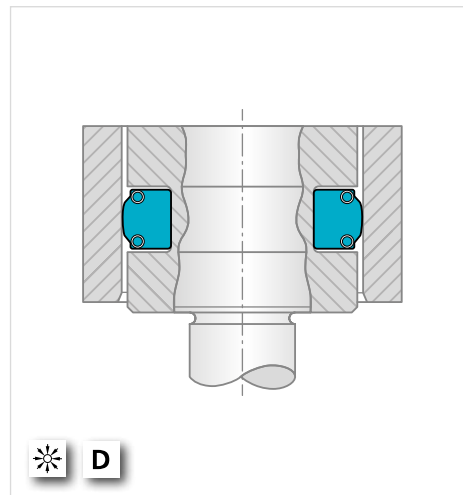

XploR™ FS-Seal

MATERIALS: Elastomeric, Metal

Profiled elastomer seal with 2 intergral anti-extrusion springs. Designed to take up large tolerances on mating hardware.

APPLICATIONS: oil and gas wellhead, tubing and casing hanger

Ø Range	Pressure Range	Temperature Range	Gap Covered
50 – 600 mm	103.4 MPa	-20 °C to +200 °C	–
1.969 in – 23.62 in	15,000 psi	-4 °F to +392 °F	–

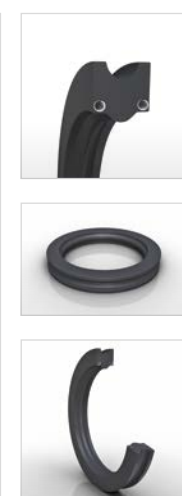
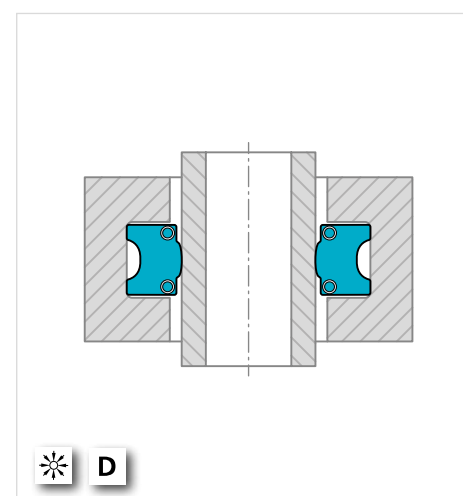

KEY TO APPLICATIONS: Reciprocating = Rotary = Oscillating = Helix = Static = Single-acting = **S** Double-acting = **D**



Flange Seals

MATERIAL: Zurcon®

SAE Flange Seals provide high functional security and can easily be mounted and dismantled. They are used in a variety of applications including hydraulics, press manufacturing and materials-handling. SAE Flange Seals corresponding to SAE J 518 are available in three different variants: O-Rings, Rectangle Seals and Zurcon® Flange Seals DRV5

APPLICATIONS: mobile hydraulics, general mechanical applications

Ø Range	Pressure Range	Temperature Range	Velocity
15 – 50 mm	42 MPa	-35 °C +110 °C*	–
0.59 in – 2 in	6,000 psi	-31 °F +230 °F*	–

* -50°C to 110°C for Zurcon® Z22 version
 * -55°F to 230°F for Zurcon® Z22 version

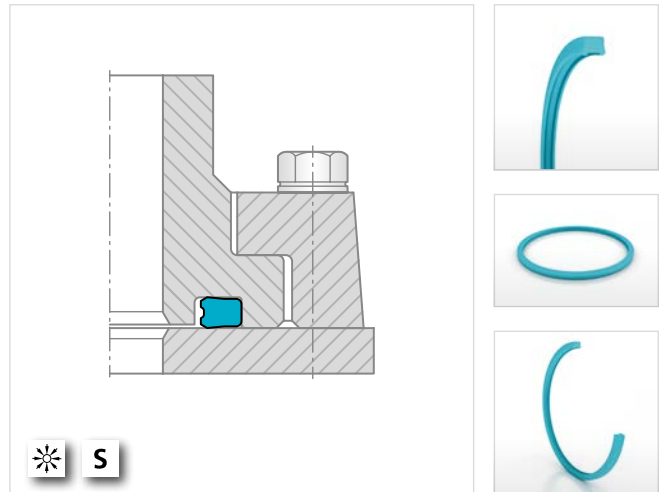

Bonded Seal

MATERIALS: Elastomeric, Metal

These are sealing discs that seal threads and flange joints. The discs consist of a metallic ring and a rubber sealing pad bonded together. Available in metric and inch dimensions.

APPLICATIONS: general purposes, general machine operation, automotive industry

Ø Range	Pressure Range	Temperature Range	Velocity
M2.5 – M125	100 MPa	-30 °C +200 °C	–
1/8 in – 2 1/2 in	14,500 psi	-22 °F +392 °F	–

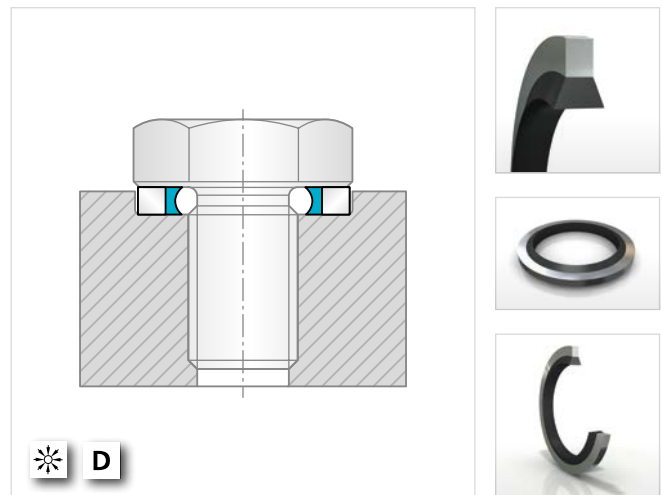

Airseal

MATERIAL: Elastomeric

Airseals are tubular elastomer seals activated by internal pressurization (inflatable seals) with air, water or other media. Airseals are used wherever reliable sealing of accesses to plants, containers and rooms are required. They represent a technically improved alternative to the standard contact pressure seals and can be easily adapted to match the surface to be sealed.

APPLICATIONS: chemical industry, general mechanical applications

Ø Range	Pressure Range	Temperature Range	Gap Covered
50 – 4,000 mm	1 MPa	-50 °C +220 °C	1 – 76 mm
2 in – 157 in	145 psi	-58 °F +428 °F	0.04 in – 2.99 in

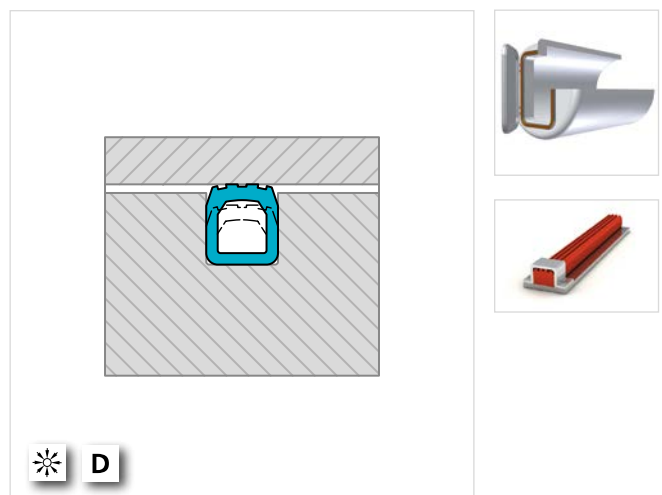

KEY TO APPLICATIONS: Reciprocating = Rotary = Oscillating = Helix = Static = Single-acting = **S** Double-acting = **D**



Elastomeric O-Ring

MATERIAL: Elastomeric

A double-acting seal for static and dynamic applications. Available in various materials including NBR, FKM, FFKM, EPDM, chloroprene, silicone and fluorosilicone. Available to ISO 3601, AS 568 and other recognized standards.

APPLICATIONS: general purposes

Ø Range	Pressure Range	Temperature Range	Velocity
from 0.5 mm	200 MPa	-60 °C +325 °C	0.5 m/s
from 0.02 in	29,000 psi	-75 °F +617 °F	1.6 ft/s

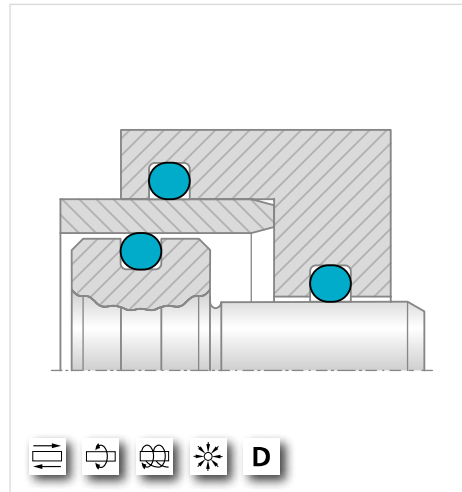

Polyurethane O-Ring

MATERIALS: Zurcon®, Polyurethane

Polyurethane O-Rings are especially suited wherever O-Rings are subject to dynamic loads. This includes, for example, applications in hydraulics, pneumatics and in a wide range of other critical areas. In many cases, polyurethane O-Rings are used instead of NBR due to their high mechanical strengths.

APPLICATIONS: hydraulics, abrasion resistance

Ø Range	Pressure Range	Temperature Range	Velocity
from 2.5 mm	200 MPa*	-50 °C +100 °C	0.5 m/s
from 0.1 in	29,000 psi	-58 °F +212 °F	1.6 ft/s

* depending on extrusion gap

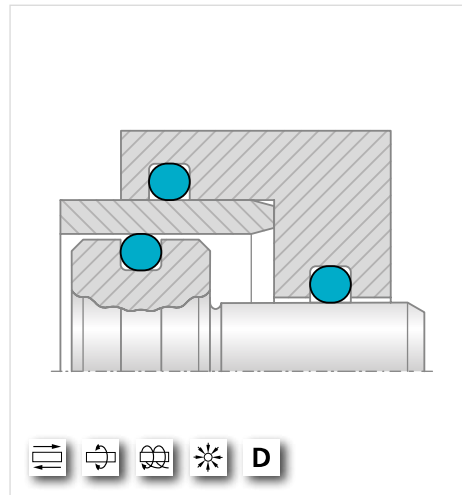

FlexiMold™ O-Ring

MATERIAL: Elastomeric

Fleximold™ is a proprietary manufacturing technology, that allows the manufacturing of large, high quality O-Rings without the leadtime and cost associated with dedicated tooling. Compared to conventional techniques such as the splicing of extruded cord, this process ensures full visual and dimensional integrity. Tolerances according to ISO 3601-1, class B apply for the inside diameters and cross sections. (Available in Isolast FFKM compounds)

APPLICATIONS: general purpose, large dimensions

Ø Range	Pressure Range	Temperature Range	Velocity
0.6 mm – infinite	200 MPa	-40 °C +325 °C	-
0.023 in – infinite	29,000 psi	-40 °F +617 °F	-

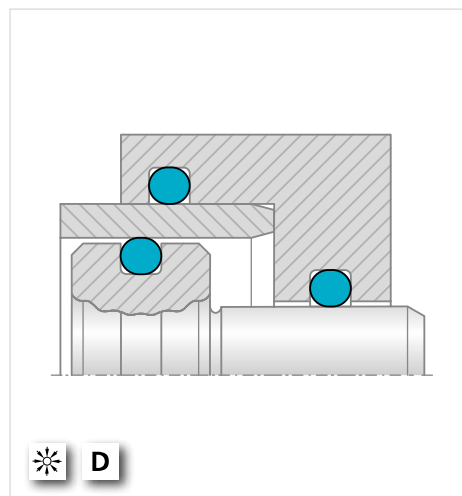

KEY TO APPLICATIONS: Reciprocating = Rotary = Oscillating = Helix = Static = Single-acting = **S** Double-acting = **D**



FEP O-Ring

MATERIALS: Elastomeric, Other Polymeric, Metal

This encapsulated O-Ring is produced from silicone or fluorocarbon with a seamless FEP jacket. These seals can solve sealing problems due to their chemical resistance coupled with elastic properties and low friction. Available to ISO 3601, AS 568 and BS 4518 and other standards including hollow and square sections. Available in both inch and metric sizes.

APPLICATIONS: chemical industry, aggressive media

Ø Range	Pressure Range	Temperature Range	Velocity
from 7.7 mm	25 MPa	-60 °C +200 °C	–
from 0.300 in	3,625 psi	-76 °F +392 °F	–

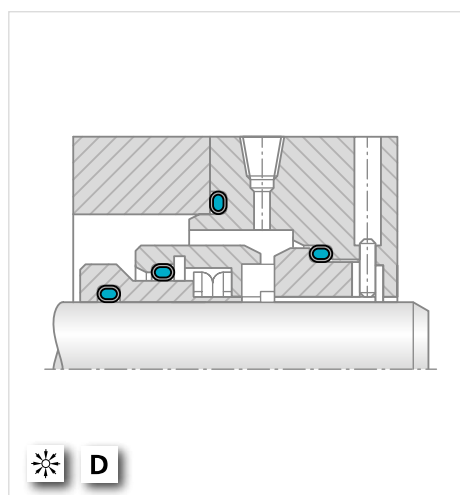

PTFE O-Ring

MATERIAL: PTFE

For axial static face or flange-type applications. Resistant to practically all chemicals and to high temperatures. Available in any required size.

APPLICATIONS: chemical industry, aggressive media

Ø Range	Pressure Range	Temperature Range	Velocity
0.5 – 1,000 mm	40 MPa	-200 °C +260 °C	–
0.02 in – 39 in	5,800 psi	-328 °F +500 °F	–

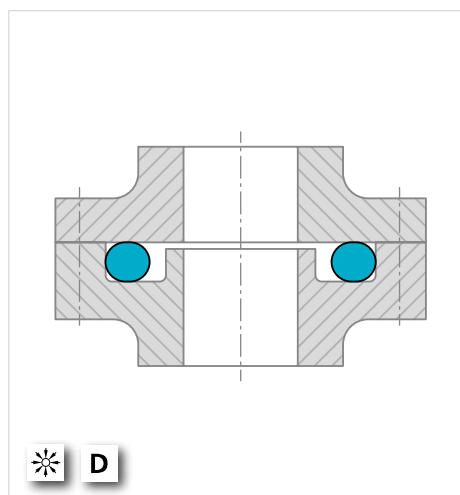

Isolast® FFKM Perfluoroelastomer O-Ring

MATERIAL: Elastomeric

Isolast® is Trelleborg Sealing Solutions proprietary perfluoroelastomer. It combines the elastic properties of fluorocarbon (FKM) with the outstanding chemical resistance and the high temperature stability of PTFE. Isolast® seals can be used for applications in high temperature service up to +325 °C / +615 °F. Isolast® O-Rings are available in metric and inch dimensions to ISO 3601 and AS 568 for various applications in oil and gas, semiconductor, aerospace and chemical processing industries.

APPLICATIONS: chemical industry, aggressive media, high temperatures

Ø Range	Pressure Range	Temperature Range	Velocity
from 0.8 mm	200 MPa	-40 °C +325 °C	–
from 0.031 in	29,000 psi	-40 °F +617 °F	–

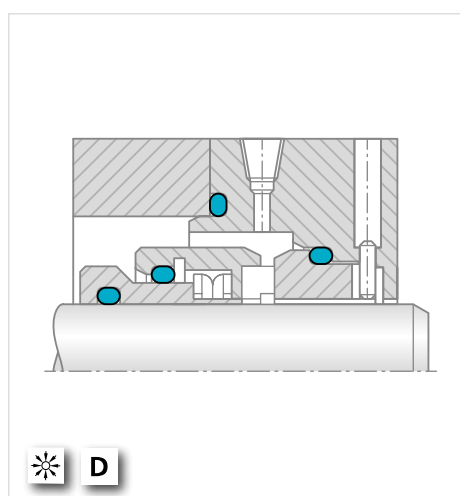

KEY TO APPLICATIONS: Reciprocating = Rotary = Oscillating = Helix = Static = Single-acting = **S** Double-acting = **D**

! This page is intentionally left blank.



Rotary Seals

For further literature, films, animations and mobile tools for rotary seals, scan the QR-Code:



ROTARY SEAL SELECTOR



The Rotary Seal Selector allows you to find suitable products for your application's specific conditions from the wide range of rotary seals and materials available. **For more information scan the QR-Code or visit our website: www.trelleborg.com/seals**

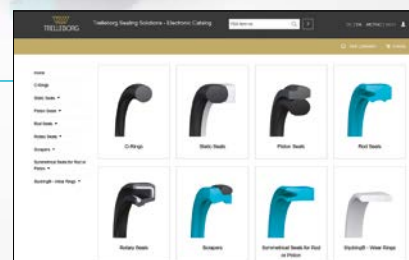



Radial Oil Seal

MATERIAL: Elastomeric, Metal

Radial oil seals are designed for sealing shafts and spindles. Providing long-lasting sealing efficiency, they consist of a rubber sealing lip, metal case and a spiralled tensioning spring. Available with or without external dust lip, they are self-retained in an open groove to ISO 6194 and DIN 3760. Versions come without the spring for grease applications, for use as a scraper or for helical movement.

APPLICATIONS: general purpose, general mechanical applications

Ø Range	Pressure Range	Temperature Range	Velocity
4 – 800 mm	1 MPa	-30 °C +200 °C*	10 m/s
0.157 in – 31.49 in	145 psi	-22 °F +390 °F*	33 ft/s

* temperature range of the compound

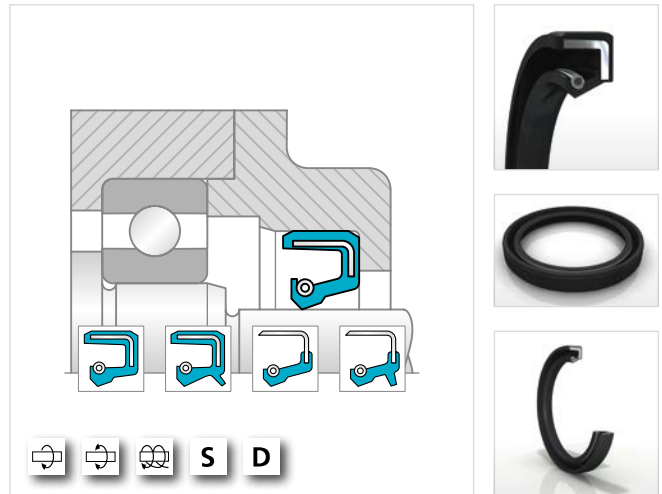

HiSpin® HS40

MATERIALS: Elastomeric, Metal

Providing outstanding low friction capabilities, HiSpin® HS40 meets the demanding conditions of automotive high-speed electric motors. A unique hydrodynamic feature helps reduce frictional torque, while oil back pumping leads to improved sealing performance without causing any shaft damage. Our proprietary XLT elastomer material ensures outstanding performance in a wide range of temperatures and lubrication conditions.

APPLICATIONS: automotive, electric motors

Ø Range	Pressure Range	Temperature Range	Velocity
10 – 350 mm	0 MPa	-45 °C +200 °C	40 m/s
0.3937 in – 13.7795	0 psi	-49 °F +392 °F	131.23 ft/s

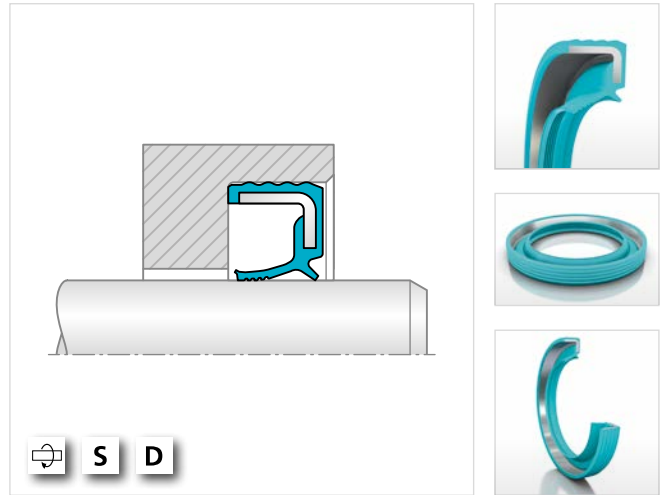

Cartridge-ROS

MATERIALS: Elastomeric, Polyurethane, Metal

Cartridge-ROS is a metal cartridge containing two or three tailored Radial Oil Seals, additional Turcon® or Zurcon® seals and a greasing pack, combining in a single package several features for easier assembly and removal during maintenance. Design and compounds engineered according to customer request.

APPLICATIONS: marine propellers, polluted environments, heavy duty industries

Ø Range	Pressure Range	Temperature Range	Velocity
shaft: 30 to 200 mm	-0.5 to 6 bar	-50 °C +130 °C	4 m/s
-		-58 °F +266 °F	13 ft/s

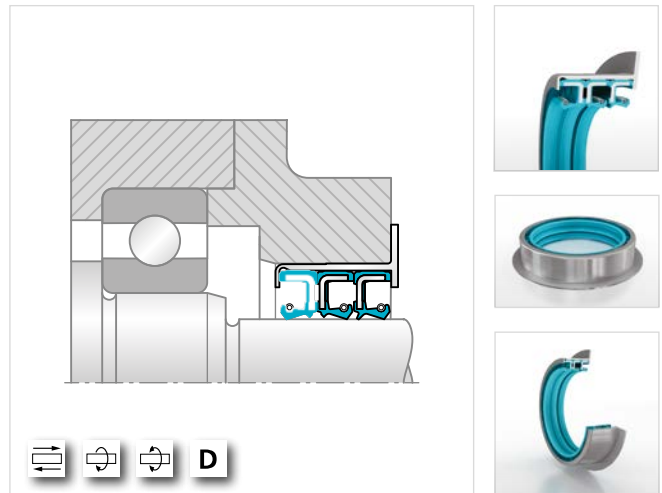

KEY TO APPLICATIONS: Reciprocating = Rotary = Oscillating = Helix = Static = Single-acting = **S** Double-acting = **D**



HP20 Rotary Oil Seal

MATERIALS: Elastomeric, Metal

HP20 is an elastomeric rotary oil seal suitable for sealing medium to high hydraulic oil pressure at low to medium shaft speeds. Available in FPM and HNBR for standard and low temperature environments.

APPLICATIONS: hydraulics, motors and pumps, mobile hydraulics, heavy operation

Ø Range	Pressure Range	Temperature Range	Velocity
up to 300 mm	up to 4,7 mt/s	-30 °C +100 °C	4 m/s
-	up to 200 bar	-22 °F +212 °F	13 ft/s

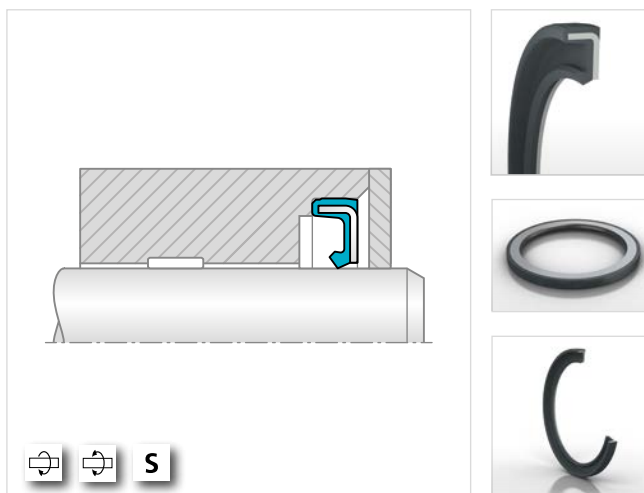

HS-APJ Cassette Seal

MATERIALS: Elastomeric, Metal

The HS-APJ Cassette Seal is an evolution of the APJ Cassette Seal, suitable for high speed applications. It includes a sleeve, usually made from stainless steel, that simplifies customer hardware, and a Radial Oil Seal with integrated axial V-Rings. Supplied pre-greased.

APPLICATIONS: robotics, high speed, gearboxes exposed to polluted environments, propeller shafts

Ø Range	Pressure Range	Temperature Range	Velocity
up to 300 mm	-	-30 °C +130 °C	up to 20 m/s
-	-	-22 °F +266 °F	65 ft/s

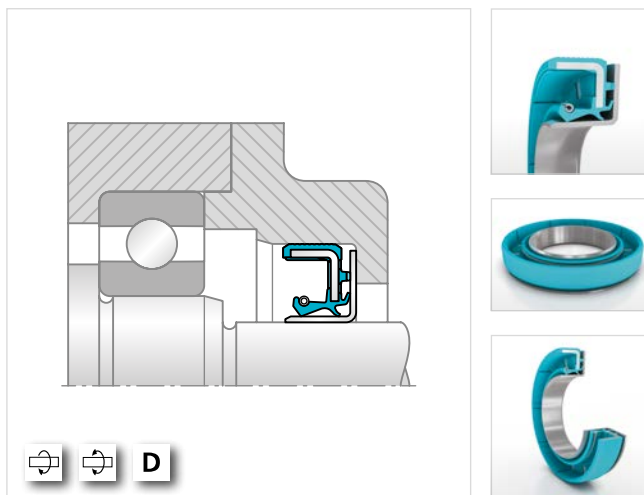

Skyseal

MATERIALS: Turcon®, PTFE, Elastomeric, Metal

Skyseal combines the benefits of an elastomeric rotary oil seal with advantages of a Turcon® Varilip® PDR on the air side within a single, compact seal.

APPLICATIONS: actuators and gearboxes, exposed to external contaminants, and pressurized gasses

Ø Range	Pressure Range	Temperature Range	Velocity
up to 200 mm	-0.5 to 3 bar	-50 °C +100 °C	up to 20 m/s
-	-	-58 °F +212 °F	65 ft/s

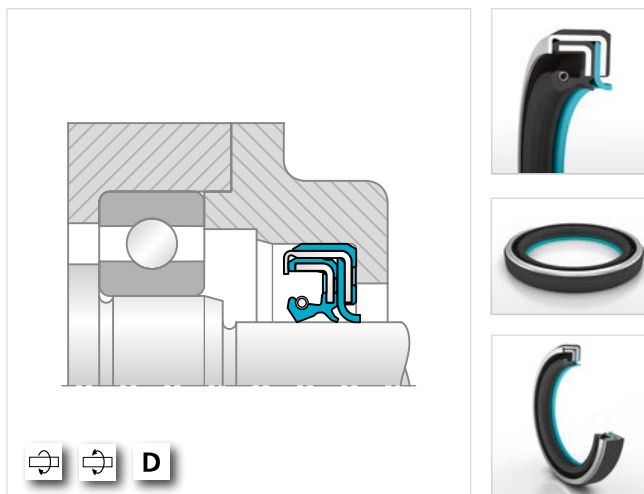

KEY TO APPLICATIONS: Reciprocating = Rotary = Oscillating = Helix = Static = Single-acting = **S** Double-acting = **D**



STEFA System 500 / 2000 / 3000 / 5000 and Cassette Seal CSL 1500

MATERIALS: Elastomeric, Metal

All Cassette seal systems have a completely enclosed seal providing the functions of oil seal, wear sleeve and dust protection in one unit. It has been developed to meet the ever increasing requirements of long service life, high functional reliability, environmental safety and easy installation. All these Cassette Seals are used in heavy duty vehicle axles, hubs and industrial gearboxes.

APPLICATIONS: mobile hydraulics, construction machinery, tractors, trucks

Ø Range	Pressure Range	Temperature Range	Velocity
90 – 320 mm	0.05 MPa	-30 °C +200 °C	15 m/s
3.5 in – 12.5 in	7 psi	-22 °F +392 °F	50 ft/s

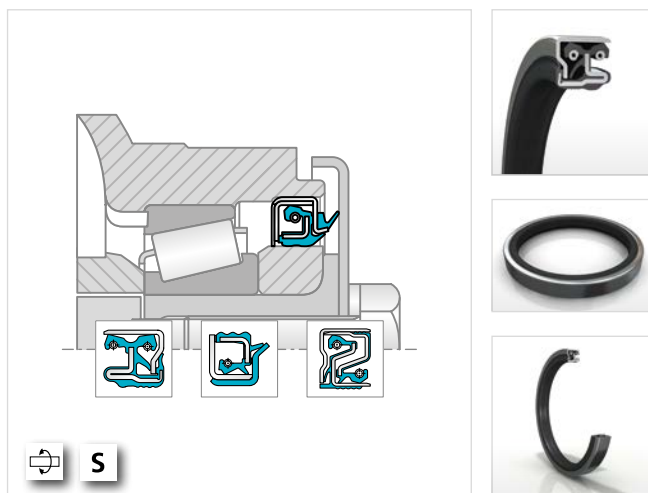

Shaft Repair Kit

MATERIAL: Metal

Suitable for the repair of worn shafts or for original equipment manufacturing to avoid the need to harden the shaft. Shaft repair kits are thin-walled stainless steel sleeves which do not require any modification to the existing seal sizes. Tools for installation on the shaft are included in the kit.

APPLICATIONS: repair of worn shafts, for non-hardened shaft

Ø Range	Pressure Range	Temperature Range	Velocity
12 – 200 mm	–	–	–
0.472 in – 8 in	–	–	–

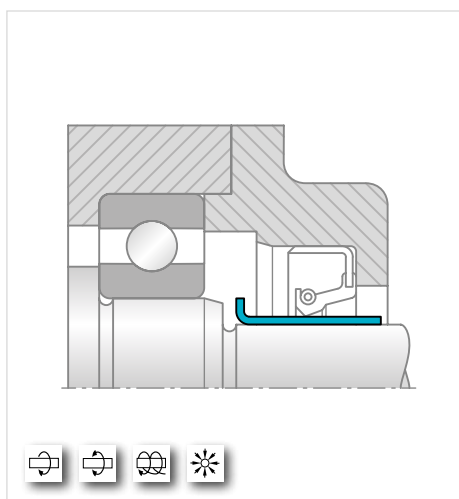

End Cover

MATERIALS: Elastomeric, Metal

End Covers consist of a metal cap which has been rubber coated. They are used to plug seal gaps or holes. They are often used as a substitute for sealing flanges and covers in gear manufacturing.

APPLICATIONS: gear manufacturing

Ø Range	Pressure Range	Temperature Range	Velocity
10 – 230 mm	–	-30 °C +200 °C	–
0.39 in – 9 in	–	-22 °F +392 °F	–

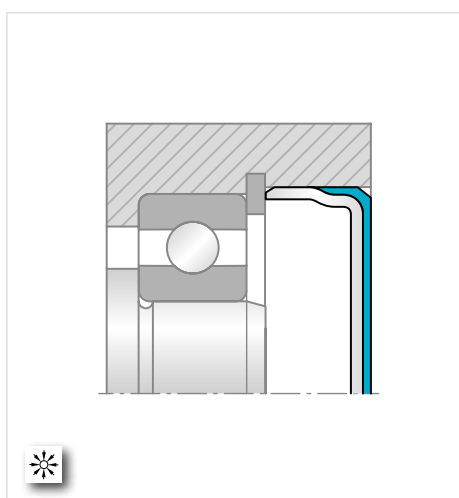

KEY TO APPLICATIONS: Reciprocating = Rotary = Oscillating = Helix = Static = Single-acting = **S** Double-acting = **D**



HiSpin® PDR RT

MATERIALS: Turcon®, PTFE, Metal

Running in dry, moist or lubricated environments, HiSpin® PDR RT meets ever growing demand for seal integrity at increasingly higher rotational speeds. The seal has excellent sealing characteristics at speeds of up to at least 60 meters per second. A combination of a unique material, an innovative manufacturing process and specialized sealing lip design, reduces the friction by up to 75 % when compared to traditional PTFE seals, leading to a significant reduction in power consumption.

APPLICATIONS: automotive, electric motors

Ø Range	Pressure Range	Temperature Range	Velocity
10 – 100 mm	0.2 MPa	-60 °C +260 °C	60 m/s
0.3937 in – 3.937 in	29 psi	-76 °F +500 °F	196.85 ft/s

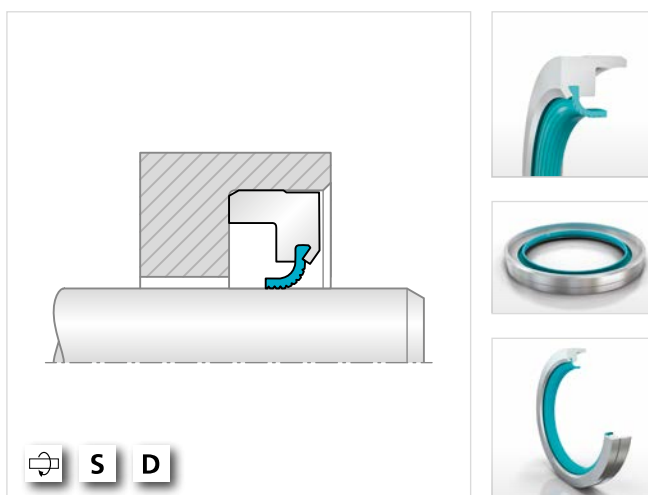

Turcon® Roto L

MATERIALS: Turcon®, Elastomeric, Metal

The Turcon® Roto L seal is engineered to extend the life time of Central Tire Inflation Systems by lowering friction, also saving energy and fuel. This is achieved by only sealing when it is required during tire pressure adjustment. The seal body is available in NBR, HNBR and FKM materials and the sealing lip in Turcon® M12 and Turcon® M83.

APPLICATIONS: industrial, automotive, agriculture, construction

Ø Range	Pressure Range	Temperature Range	Velocity
shaft 10 mm to 400 mm	1 MPa	-40 °C +200 °C	25m/s (PV11barm/s)
–		-40 °F +392 °F	82 ft/s

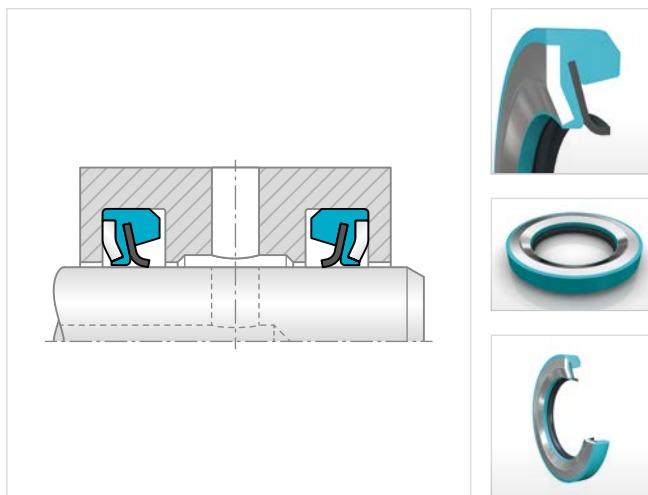

Turcon® Varilip® PDR

MATERIALS: Turcon®, Metal

Turcon® Varilip® PDR seals are PTFE rotary shaft lip seals suitable for high surface speeds with low pressure. They provide stick-slip-free running with low friction and wide media and temperature range compatibility.

APPLICATIONS: general purpose, general mechanical applications, compressors, vacuum pumps, gearboxes

Ø Range	Pressure Range	Temperature Range	Velocity
6 – 170 mm	1 MPa	-60 °C +200 °C	60 m/s
0.438 in – 4.25 in	145 psi	-76 °F +392 °F	197 ft/s

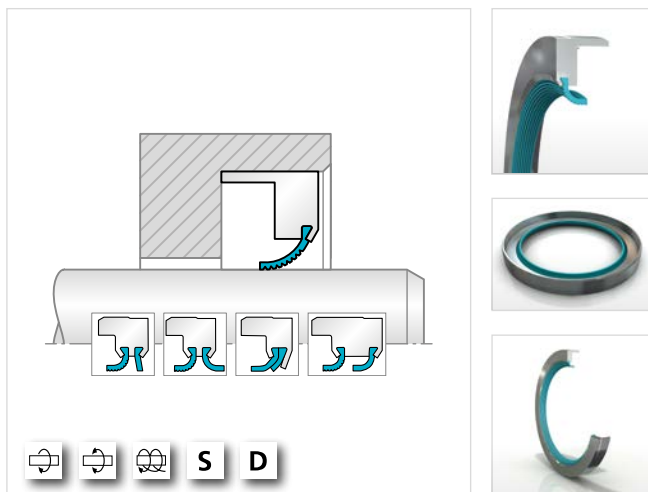

KEY TO APPLICATIONS: Reciprocating = Rotary = Oscillating = Helix = Static = Single-acting = S Double-acting = D

Boost your ride with next-generation e-axle sealing

now

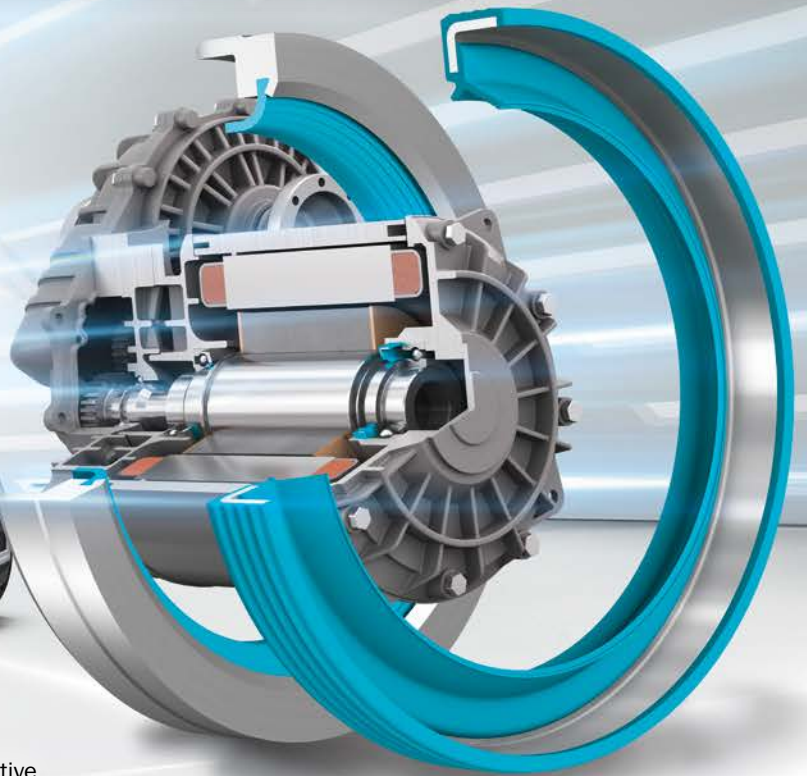

Seals to Make Next Generation Electric Cars a Reality

If mass adoption of electric cars is to be a reality, then effective sealing of the e-axle is a necessity to optimize performance and extend travel distance from one charge. HiSpin® PDR RT and HiSpin® HS40, specifically developed for e-mobility applications, represent a significant step in making this possible.

Find out more by visiting www.tss.trelleborg.com/accelerate
or scanning the QR code.





Forsheda® V-Ring

MATERIAL: Elastomeric

The Forsheda® V-Ring fits directly onto the shaft and seals axially against a counterface, such as shaft collar, thrust washer or bearing face. Its light lip pressure generates low friction.

APPLICATIONS: general purpose, general mechanical applications

Ø Range	Pressure Range	Temperature Range	Velocity
3 – 11,500 mm	–	-40 °C +200 °C	18 m/s
0.118 in – 452 in	–	-40 °F +392 °F	59 ft/s

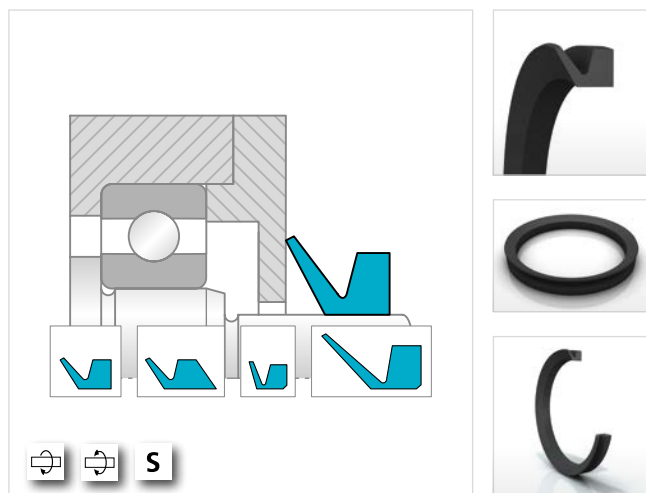

GAMMA Seal

MATERIALS: Elastomeric, Metal

The GAMMA Seal is an axial rotary seal that excludes contamination, moisture and grease. It consists of an elastomer sealing lip contained in a metal carrier. This design copes with arduous static and dynamic conditions in mobile hydraulics and power transmission applications.

APPLICATIONS: mobile hydraulics, power transmission

Ø Range	Pressure Range	Temperature Range	Velocity
10 – 225 mm	–	-40 °C +200 °C	20 m/s
0.394 in – 9 in	–	-40 °F +392 °F	65 ft/s

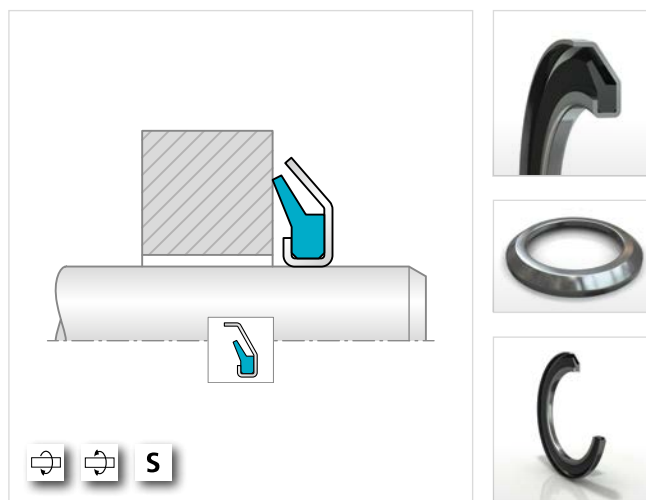

Turcon® Roto Glyd Ring®

MATERIAL: Turcon®, Elastomeric

A double-acting O-Ring energized seal designed for rotating, oscillating and helically moving pistons, rods and shafts. It is installed in grooves to ISO 7425 and is available in a single-acting version for higher rotating speeds.

APPLICATIONS: hydraulics, general purpose, rotary applications

Ø Range	Pressure Range	Temperature Range	Velocity
6 – 2,600 mm	30 MPa	-45 °C +200 °C	2 m/s
0.236 in – 102 in	4,350 psi	-49 °F +392 °F	6.5 ft/s

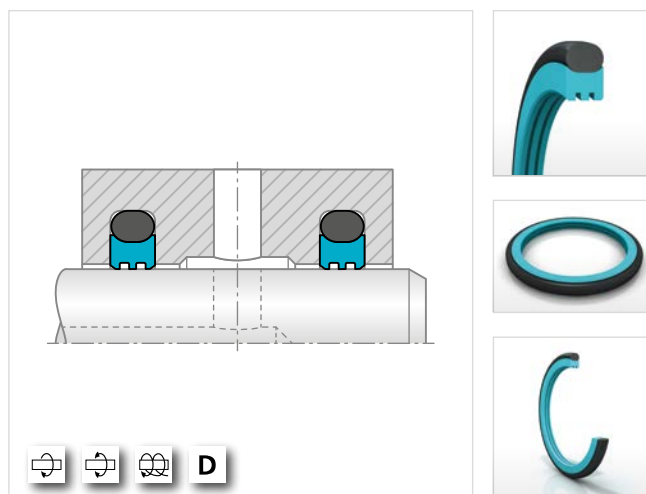

KEY TO APPLICATIONS: Reciprocating = Rotary = Oscillating = Helix = Static = Single-acting = **S** Double-acting = **D**



Turcon® Roto Glyd Ring® II

MATERIALS: Turcon®, Zurcon®, Elastomeric

The Turcon® Roto Glyd Ring® II is a double-acting, bi-directional seal for demanding applications. In rotary applications, the Turcon® Roto Glyd Ring® II offers outstanding stability in the gland hardware. It consists of a permanently bonded elastomer energizer and a PTFE-based seal ring to form a one-piece bonded construction that gives increased service life by preventing the seal's PTFE-based sealing ring from spinning with the shaft against the elastomer energizer.

APPLICATIONS: a bonded one-piece seal for demanding rotary applications which require a custom solution

Ø Range	Pressure Range	Temperature Range	Velocity
2.5 – 1,016 mm	35 MPa	-60 °C +200 °C	2.5 m/s
0.100 in – 40.0 in	5,000 psi	-76 °F +392 °F	8 ft/s

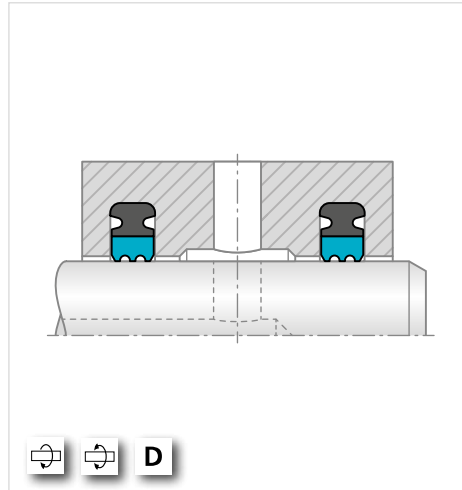

Turcon® Roto Glyd Ring® V

MATERIALS: Turcon®, Zurcon®, Elastomeric

A built-in valve function bypasses the upstream “leg” facing the pressure. This ensures that only the downstream “leg” is pressurized and sealing, whereas the upstream part of the seal is pressure-balanced and does not contribute to torque. This reduces the contact surface to improve friction, wear resistance and tightness.

APPLICATIONS: machine tool industry, mainly machining centers, hydraulic swivels, rotary connections with swivel movement, hydraulic rotators, robotics, manipulators, indexing tables

Ø Range	Pressure Range	Temperature Range	Velocity
Shaft 35 to 500 mm Bore 22 to 500 mm	30 MPa	-45 to +130 °C (up to +150 °C at lower PV-values)	2 m/s
–	4,350 psi	-49 to +266 °F (up to +302 °F at lower PV-values)	6.5 ft/s

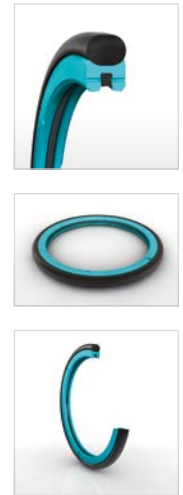
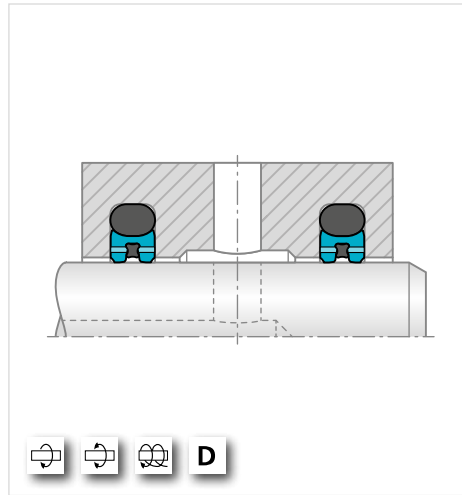

Roto Glyd Ring® DXL

MATERIALS: Turcon®, Zurcon®, Elastomeric

Roto Glyd Ring® DXL provides outstanding friction performance and extrusion protection in high pressure applications and those subject to high PV values.

APPLICATIONS: hydraulic swivels, downhole tools, rotating control devices, top drives, hydraulic motors

Ø Range	Pressure Range	Temperature Range	Velocity
13 – 380 mm	70 MPa	-30 °C +150 °C	5 m/s Rotating
0.500 – 15 in	10,150 psi	-22 °F +302 °F	16.4 ft/s Rotating

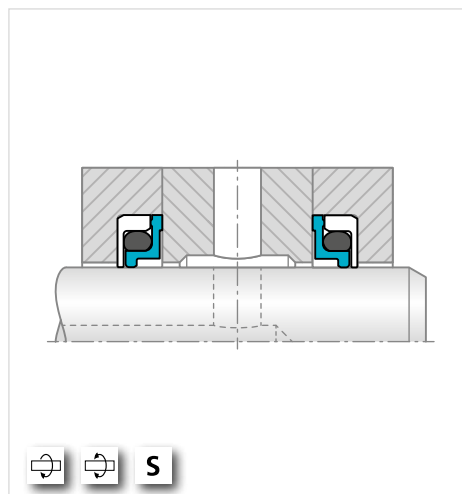

KEY TO APPLICATIONS: Reciprocating = Rotary = Oscillating = Helix = Static = Single-acting = **S** Double-acting = **D**



Turcon® Roto Variseal®

MATERIALS: Turcon®, Zurcon®, Metal

A single-acting sealing element comprised of a U-shaped Turcon® ring and metallic energizing finger spring. It offers low friction with no stick-slip, minimized breakout force and high wear resistance. Its constrained flange eliminates potential seal rotation and it is resistant to most liquids and chemicals. Unlimited shelf life.

APPLICATIONS: general mechanical applications, chemical industry

Ø Range	Pressure Range	Temperature Range	Velocity
5 – 3,300 mm	S: 25 MPa D: 20 MPa	-70 °C +300 °C	L: 15 m/s R: 2 m/s
0.197 in – 130 in	S: 3,625 psi D: 2,900 psi	-94 °F +572 °F	L: 50 ft/s R: 6.5 ft/s

S = Static, D = Dynamic, L = Linear, R = Rotary

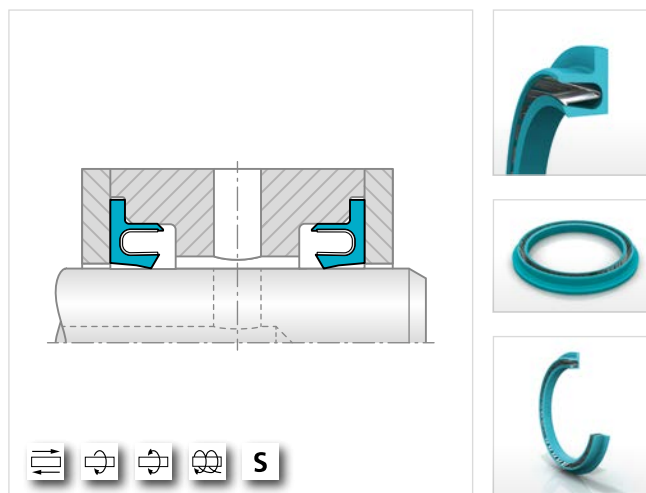

Turcon® Roto VL Seal®

MATERIALS: Turcon®, Zurcon®, Elastomeric

Single-acting seal for rotary, turning and oscillating movements for pistons, rods and shafts in a wide range of machinery. The O-Ring activated L-shaped Turcon® or Zurcon® seal element gives optimized low frictional static and dynamic sealing performance. Offers high wear and chemical resistance depending on seal and O-Ring material. Installed in closed, standard O-Ring grooves.

APPLICATIONS: hydraulics, general rotary machine applications, construction, swivels and rotary connections

Ø Range	Pressure Range	Temperature Range	Velocity
6 – 2,600 mm	up to 30 MPa	-40 °C +120 °C (+150 °C)	2 m/s
0.236 in – 102 in	up to 4,350 psi	-49 °F +392 °F	6.5 ft/s

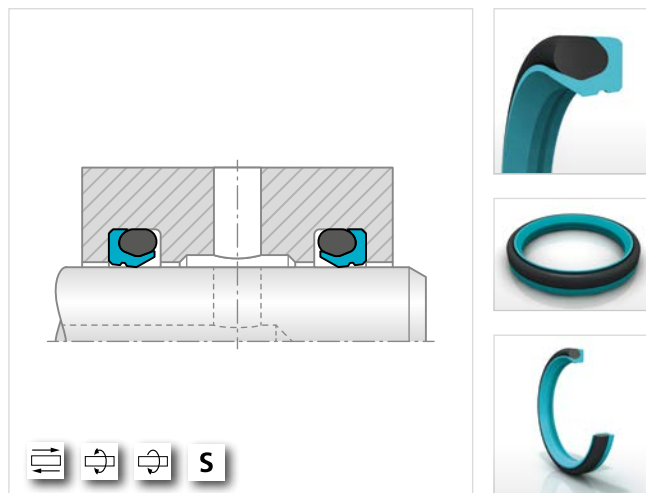

Zurcon® Roto Glyd Ring® S

MATERIAL: Zurcon®, Elastomeric

Double-acting O-Ring energized seal designed for oscillating moving pistons, rods and shafts. It offers low friction performance in rotary transmission lead throughs and indexing tables.

APPLICATIONS: machine tools, rotary connections

Ø Range	Pressure Range	Temperature Range	PV
12 – 2,700 mm	40 MPa	-30 °C +100 °C	up to 6.5 MPa x m/s
0.472 in – 106 in	5,800 psi	-22 °F +212 °F	up to 2,916 psi x ft/s

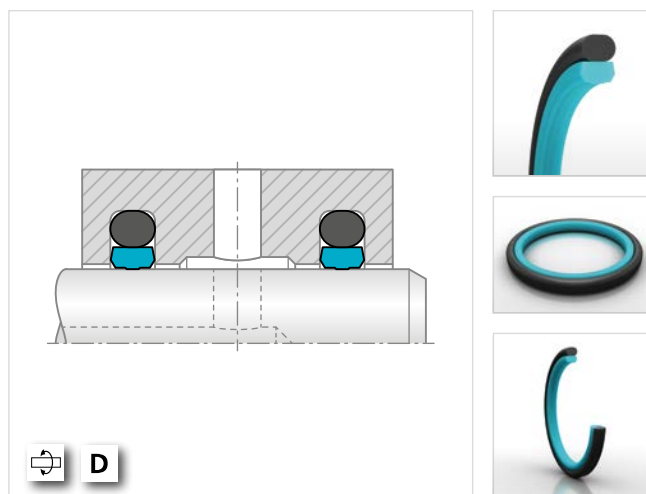

KEY TO APPLICATIONS: Reciprocating = Rotary = Oscillating = Helix = Static = Single-acting = **S** Double-acting = **D**



Mechanical Face Seals





MATERIAL: Metal, Elastomeric

Mechanical Face Seals are a special form of mechanical seals. They are also known under other designations, such as lifetime seals, floating seals, duo cone seals, toric seals and heavy duty seals.

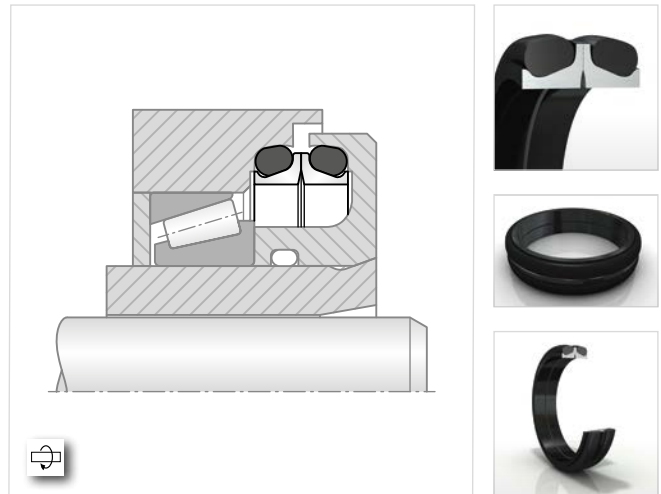
APPLICATIONS: tracked vehicles, tunnel boring machines, heavy trucks, conveyor systems

Ø Range	Pressure Range	Temperature Range	Velocity
45 – 886 mm	0.15 MPa	-50 °C +200 °C	3 m/s
1,772 in – 34.8 in	21.7 psi	-58 °F +392 °F	10 ft/s



KEY TO APPLICATIONS: Reciprocating =  Rotary =  Oscillating =  Helix =  Static =  Single-acting = **S** Double-acting = **D**



Bearings & Bushings

For further literature,
films, animations and
mobile tools for
bearings & bushings,
scan the QR-Code:





Turcite® -B Slydway®

MATERIAL: Turcite®

Turcite® -B Slydway® is a low friction linear bearing strip C for use primarily on the ways and gibs of machine tools. It provides low friction, stick-slip-free operation, long life and minimum wear. It is installed using a two-part epoxy resin after cleaning and degreasing the bare metal surface thoroughly. The seal is dimensionally stable, maintenance-free and can be operated with or without lubrication.

APPLICATIONS: chemical industry, aggressive media

Ø Range	Radial Bearing Pressure Range	Temperature Range	Velocity
-	9 MPa	up to +260 °C	1 m/s
-	1,300 psi	up to +500 °F	3 ft/s

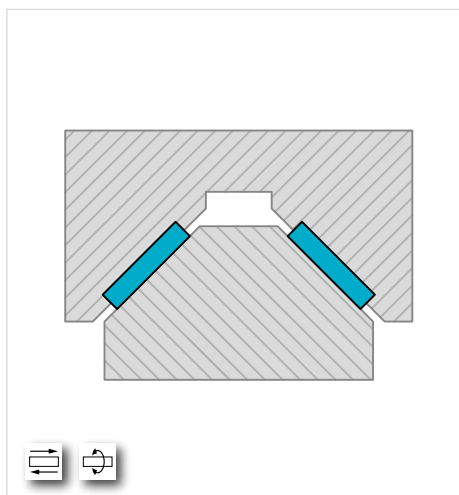

Turcite® Bearings

MATERIAL: Turcite®

High load bearings made from Turcite® are dimensionally stable, wear resistant and provide excellent performance under dry and boundary lubrication conditions.

APPLICATIONS: general mechanical applications

Ø Range	Radial Bearing Pressure Range	Temperature Range	Velocity
2 – 3,000 mm	15 MPa	-60 °C +200 °C	15 m/s
0.079 in – 118 in	2,200 psi	-76 °F +392 °F	50 ft/s

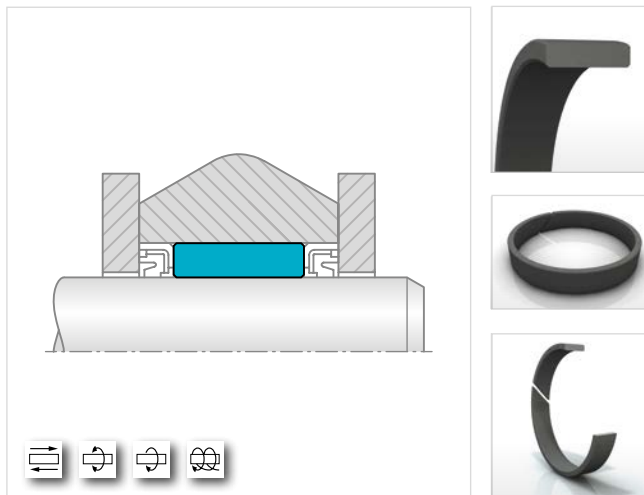

Orkot® Bearings

MATERIAL: Orkot®

Orkot bearings offer significant advantages over traditional metal bearings. All are dimensionally stable, have excellent wear resistance and outstanding low friction characteristics, giving them unrivalled performance in dry running conditions or with boundary lubrication. With virtually no swell in seawater, they are ideal for marine and hydropower applications.

APPLICATIONS: marine, hydropower, oil & gas, industrial, off-highway

Ø Range	Radial Bearing Pressure Range	Temperature Range	Velocity
2 – 3,000 mm	S: 80 MPa D: 40 MPa	-60 °C +250 °C	6 m/s
0.079 in – 118 in	S: 11,600 psi D: 5,800 psi	-76 °F +482 °F	20 ft/s

S = Static, D = Dynamic



KEY TO APPLICATIONS: Reciprocating = Rotary = Oscillating = Helix = Static = Single-acting = **S** Double-acting = **D**



Pneumatic Seals

For further literature, films, animations and mobile tools for pneumatic seals, scan the QR-Code:

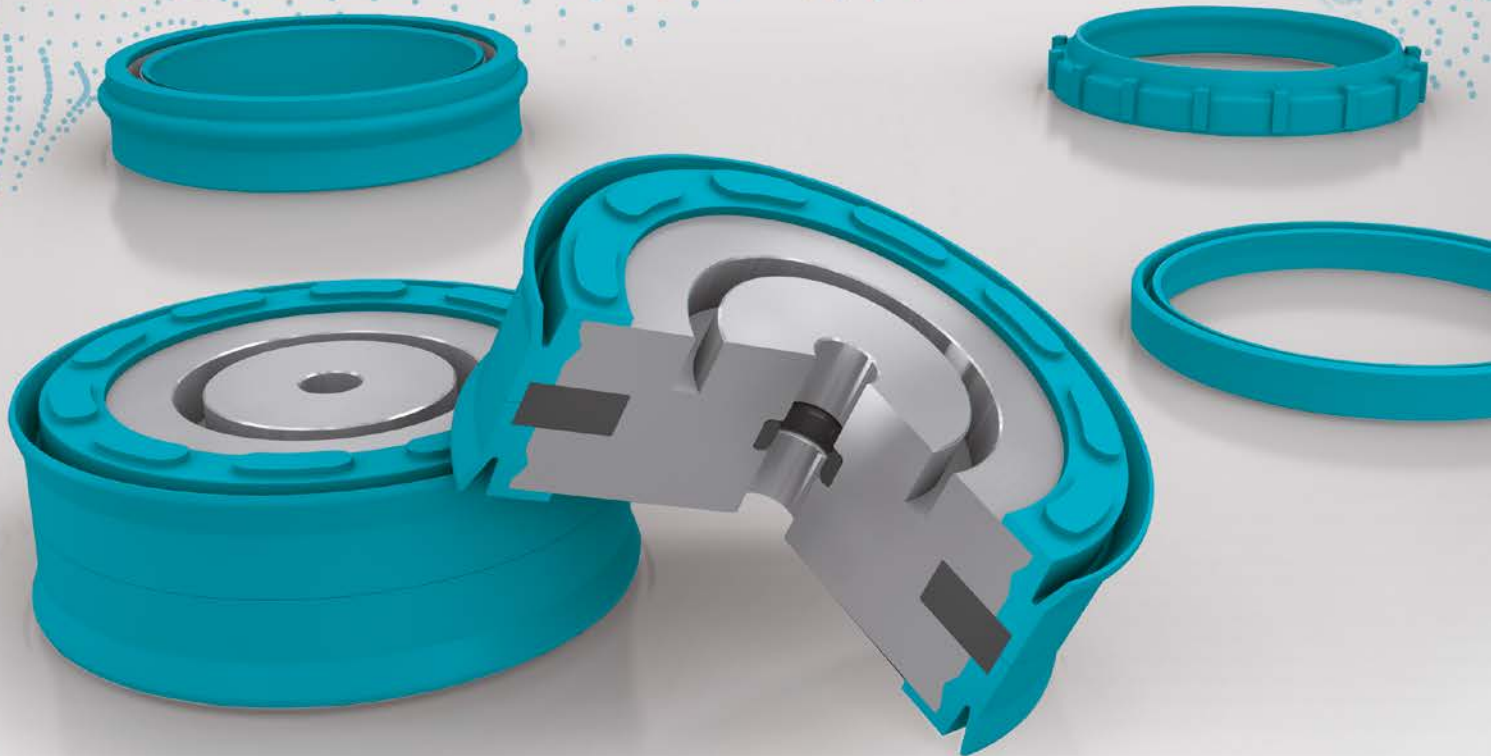



Pneumatic Piston Seal

MATERIALS: Zurcon®, Polyurethane

The pneumatic product range offers single and double-acting seals for piston applications. Made from extremely wear resistant material including Zurcon® polyurethane and FKM, these seals fit into small housings and are easily installed. The pneumatic piston seal range is recommended for standard and pneumatic cylinders with dry air.

Ø Range	Pressure Range	Temperature Range	Velocity
4 – 250 mm	1.6 MPa	-40 °C +85 °C	1 m/s
0.157 in – 10 in	232 psi	-40 °F +185 °F	3 ft/s

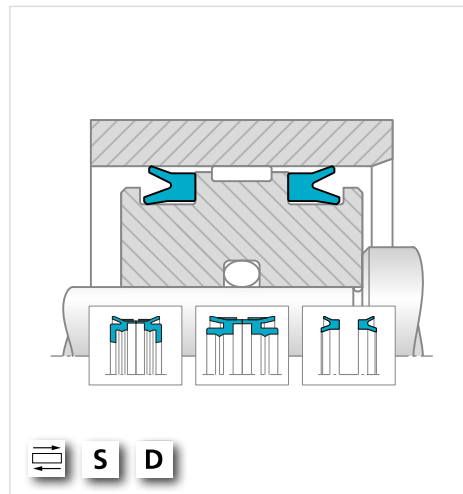

Pneumatic Wear Ring for Pistons and Rods

MATERIALS: Turcon®, Zurcon®, HiMod®

A complete range of seals and bearings for pneumatics including the most common dimensions for pistons and rods. The guide rings are made of a specially developed, self-lubricating plastic material to provide low friction, wear resistance, long term compression stability and excellent service life.

Ø Range	Pressure Range	Temperature Range	Velocity
8 – 250 mm	40 MPa	-40 °C +110 °C	1 m/s
0.315 in – 10 in	5,800 psi	-40 °F +230 °F	3 ft/s

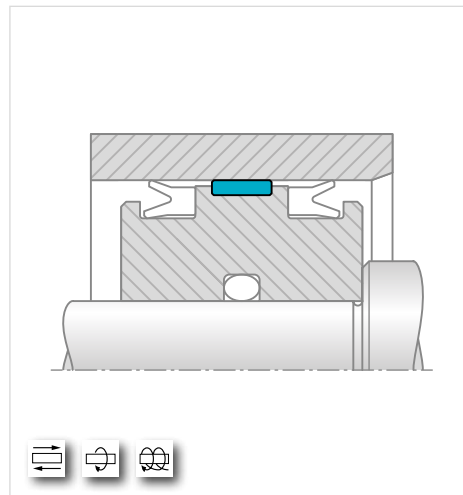

Pneumatic Rod Seal and Rod Seal - Scraper Combination

MATERIALS: Zurcon®, Elastomeric, Polyurethane

Pneumatic rod seals are available as lip seals and rod seal/scraper combinations for closed and open housings. Special materials provide high abrasion resistance and low friction cost-effectively. They are recommended for applications in standard cylinders, installed with a separate scraper or as rod seal/scraper combination for dry air.

Ø Range	Pressure Range	Temperature Range	Velocity
3 – 100 mm	1.6 MPa	-40 °C +150 °C	up to 5 m/s
0.118 in – 4 in	232 psi	-40 °F +302 °F	up to 16 ft/s

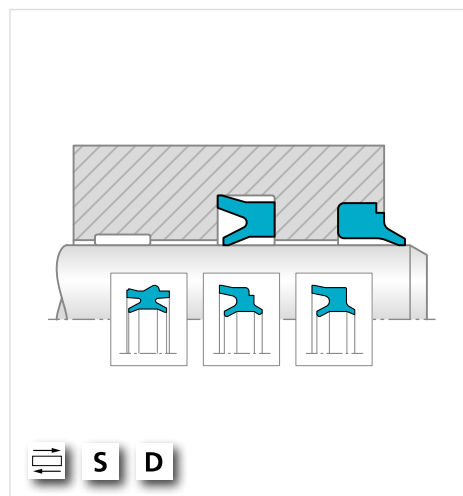

KEY TO APPLICATIONS: Reciprocating = Rotary = Oscillating = Helix = Static = Single-acting = **S** Double-acting = **D**



Pneumatic Seals ARV

MATERIAL: Zurcon®, Metal

Asymmetric Variseal® type seal with spring energized sealing lip and scraper lip. Suitable for poor lubrication, high speeds or foodstuff applications (FDA compliant). Very good protection against dirt ingress and HiClean version available with silicone filled spring cavity prevents contaminants from being entrapped. A special groove and seal design allows fast installation either automatically or manually.

Ø Range	Pressure Range	Temperature Range	Velocity
10 – 25 mm	1.6 MPa	-30 °C +80 °C	<= 5 m/s
0.39 in – 0.98 in	232 psi	-22 °F +176 °F	16 ft/s

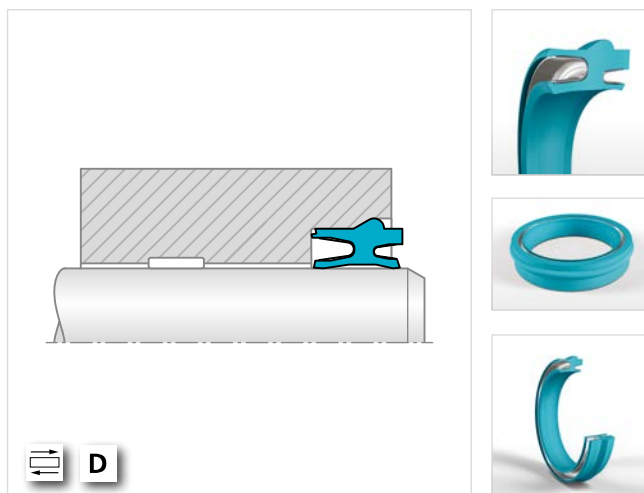

Pneumatic Scraper / Scraper for Guiding Units

MATERIAL: Polyurethane

These two versions of scrapers snap easily into open or semi-open grooves. Their special flexible lip design protects the cylinder from contamination. Where space is at a premium, the 3 mm / .118 in long type AWBB, is recommended (guiding units only).

Ø Range	Pressure Range	Temperature Range	Velocity
6 – 60 mm	–	-40 °C +80 °C	up to 4 m/s
0.236 in – 2.5 in	–	-40 °F +176 °F	up to 13 ft/s

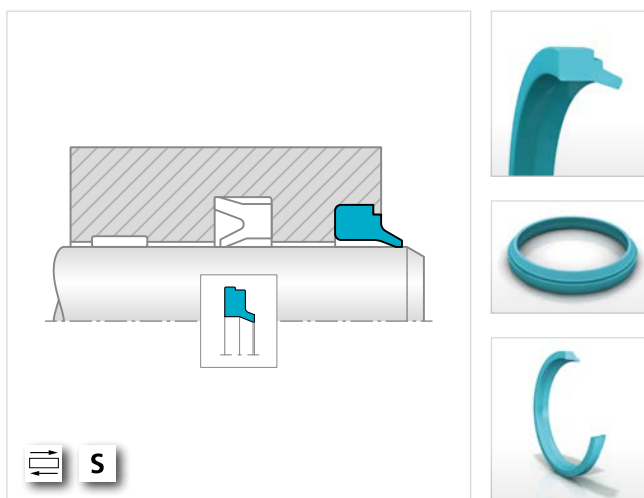

Pneumatic Cushioning Seal

MATERIALS: Zurcon®, Polyurethane

Cushioning seals provide end-of-stroke damping in pneumatic cylinders, eliminating the need for check valves. These polyurethane, high performance seal elements are user-friendly and provide an automatic centering check valve function and easy, snap-in installation.

Ø Range	Pressure Range	Temperature Range	Velocity
6 – 60 mm	1.6 MPa	-40 °C +110 °C	1 m/s
0.236 in – 2.5 in	232 psi	-40 °F +230 °F	3 ft/s

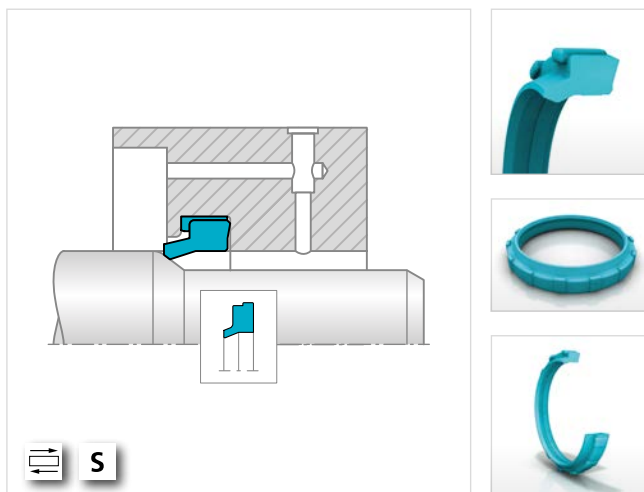

KEY TO APPLICATIONS: Reciprocating = Rotary = Oscillating = Helix = Static = Single-acting = **S** Double-acting = **D**



Pneumatic Glyd Ring® for Piston and Rods

MATERIALS: Turcon®, Zurcon®, Elastomeric

Double-acting Glyd Ring® is available as piston or rod seal and is comprised of a slipper seal and an energizing O-Ring. This means less installation space is required. Different material combinations provide solutions suitable for special pneumatic applications where minimum static and dynamic friction, low stick-slip, high speed performance or wide temperature range are required.

Ø Range	Pressure Range	Temperature Range	Velocity
3 – 2,700 mm	1.6 MPa	-30 °C +200 °C	5 m/s
0.118 in – 106 in	232 psi	-22 °F +392 °F	16 ft/s

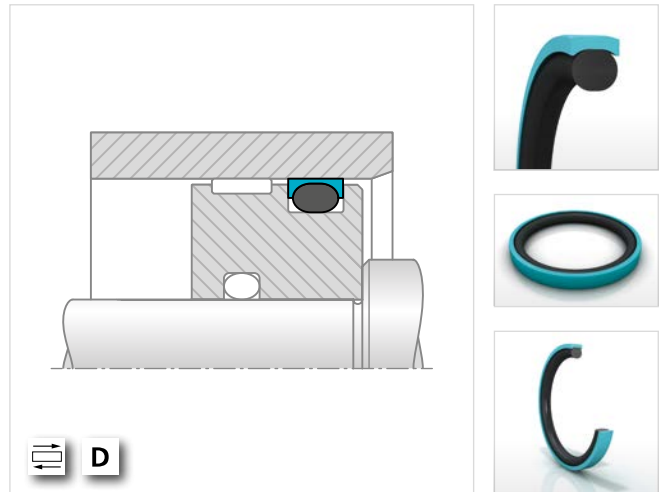

KEY TO APPLICATIONS: Reciprocating = Rotary = Oscillating = Helix = Static = Single-acting = **S** Double-acting = **D**



Rubber-to-Metal and Rubber-to-Plastic Bonded Parts

For certain applications custom seals are most suited. As your development partner, Trelleborg Sealing Solutions can work with you to design, develop and supply rubber-metal parts and bonded seals to your requirements.

Metals such as brass, aluminum, steel or stainless steel can be offered with bonding to all elastomer types.



Special and Customized Solutions in Polyurethane

Polyurethane materials have excellent elastic properties and abrasion resistance. Outstanding tensile strength and low compression set offers numerous possibilities for sealing applications within the pneumatic industry. As your development partner, Trelleborg Sealing Solutions can work with you to design and develop products suited to your requirements.

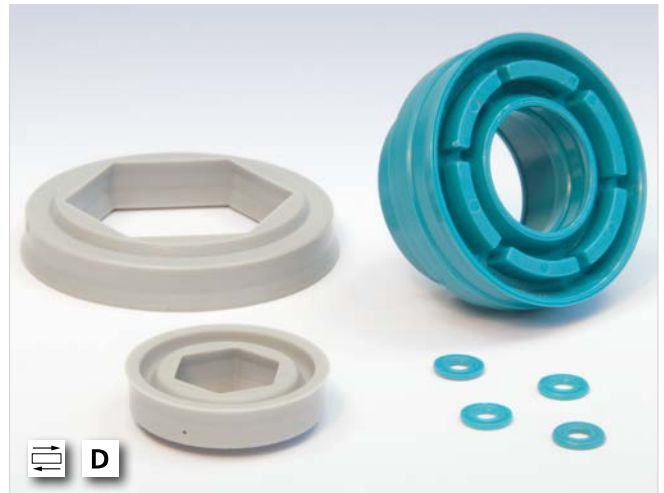





Engineered Molded Parts

MATERIAL: Elastomeric

Specialized molded parts with small profiles and specific cross sections can be offered according to ISO 3301-1/M1.

Custom molded parts and static seals are manufactured to close tolerances in a wide range of engineered materials. These are developed in conjunction with Trelleborg Sealing Solutions to the specific requirements of the customer.



KEY TO APPLICATIONS: Reciprocating =  Rotary =  Oscillating =  Helix =  Static =  Single-acting = **S** Double-acting = **D**



Complete Magnet Piston

MATERIALS: Elastomeric, Polyurethane, Metal

The Complete Magnet Piston fulfills a large number of technical requirements within the pneumatics industry with its double-acting operation, dynamic sealing capability, guidance feature and mechanical end cushioning. An NBR O-Ring statically seals the rod while an integrated magnet detects position.

Ø Range	Pressure Range	Temperature Range	Velocity
32 – 100 mm	1.6 MPa	-40 °C +80 °C	up to 1 m/s
1.25 in – 3.94 in	232 psi	-40 °F +176 °F	up to 3 ft/s

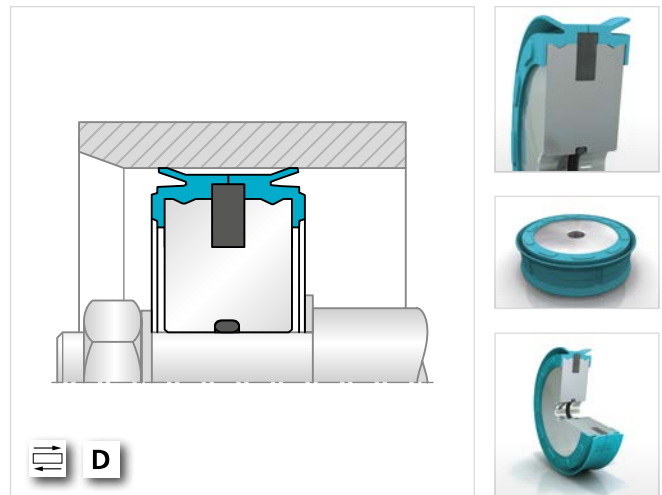

KEY TO APPLICATIONS: Reciprocating = Rotary = Oscillating = Helix = Static = Single-acting = **S** Double-acting = **D**



Surface Finishing

For further literature,
films, animations
and mobile tools for
surface finishes,
scan the QR-Code:



Seal-Glide®

MATERIALS: Zurcon®, Elastomeric, Polyurethane

Seal-Glide® is a specially formulated surface treatment that offers improved benefits when compared to standard PTFE-based coatings, delivering optimal performance on a nanoscale by using an innovative thin-film process. Meets the biocompatibility requirements of ISO 10993-5 and USP 87 and compliant with EC 1935:2004. Conforms to US FDA CFR 21, 175.300.

APPLICATIONS: medical, pharmaceutical, food processing



Flexcoat™ coatings

MATERIALS: Zurcon®, Elastomeric, Polyurethane

Micro-thin, high-performance coatings and surface modification provide the ultimate choice, maximizing friction characteristics during assembly and in dynamic applications. Most of the assembly and application professionals provide a UV-indicator. This is highlighted under ultraviolet lamps.

APPLICATIONS: computer controlled, secure processes, water-based



Temperature Range

-40 °C +175 °C

-40 °F + 347 °F

Flexcoat™ colored coatings

MATERIALS: Zurcon®, Elastomeric, Polyurethane

The primary function of any coating is to improve the friction characteristics of an elastomer seal. In addition, colored coatings enable effective differentiation of seals and 100 percent detection in production and assembly process.

APPLICATIONS: computer controlled, secure processes, water-based



Temperature Range

-40 °C +150 °C

-40 °F +302 °F

KEY TO APPLICATIONS: Reciprocating = Rotary = Oscillating = Helix = Static = Single-acting = **S** Double-acting = **D**





Flexclean™ cleaning solutions

MATERIALS: Zurcon®, PTFE, Elastomeric, Polyurethane

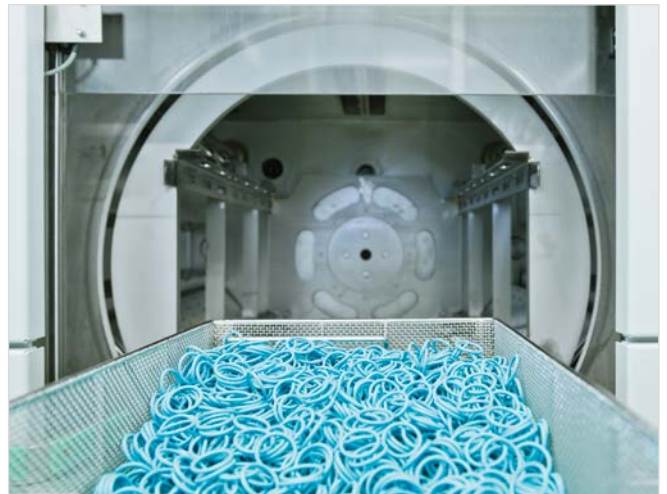
Elastomeric seals can be offered in clean conditions to various cleanliness standards. These include seals free of paint wetting impairment substances (PWIS-free), maximum allowed particle sizes of 400 µm or 200 µm based on ISO 16232 or seals washed and packed in a cleanroom class 5 according to ISO 14644-1.

APPLICATIONS: computer controlled, secure processes



KEY TO APPLICATIONS: Reciprocating =  Rotary =  Oscillating =  Helix =  Static =  Single-acting = **S** Double-acting = **D**

! This page is intentionally left blank.

Product Name	Product Range	Description Page
Airseal	Static Seals	92
Back-up Ring	Static Seals	89
Bonded Seal	Static Seals	92
Cartridge-ROS	Rotary Seals	98
Compact Seal POLYPAC® DBM	Hydraulic Seals – Piston Seals	63
Complete Magnet Piston	Pneumatic Seals	114
Diaphragms	Engineered Seals, Gaskets and other Parts	54
Elastomeric Dualseal	Static Seals	88
Elastomeric O-Ring	O-Rings	94
End Cover	Rotary Seals, Static Seals	100
Engineered HiMod® High Modulus Plastics	Engineered Seals, Gaskets and other Parts	55
Engineered Molded Parts	Non-standard Pneumatic Seals	113
Engineered Molded Parts	Engineered Seals, Gaskets and other Parts	52
Engineered PTFE Components	Engineered Seals, Gaskets and other Parts	52
Engineered Radial Oil Seal	Engineered Seals, Gaskets and other Parts	52
FEP O-Ring	O-Rings	95
Flange Seals	Static Seals	92
Flexclean™ cleaning solutions	Surface Finishing	117
Flexcoat™ coatings	Surface Finishing	116
Flexcoat™ colored coatings	Surface Finishing	116
FlexiMold™ O-Ring	O-Rings	94
Forsheda® V-Ring	Rotary Seals	103
GAMMA Seal	Rotary Seals	103
Ground Balls	Engineered Seals, Gaskets and other Parts	54
HiMod® Slydring®	Hydraulic Wear Rings	86
HiSpin® HS40	Rotary Seals	98
HiSpin® PDR RT	Rotary Seals	101
HMF FlatSeal™	Engineered Seals, Gaskets and other Parts	53
HP20 Rotary Oil Seal	Rotary Seals	99
HS-APJ Cassette Seal	Rotary Seals	99
Isolast® FFKM Perfluoroelastomer O-Ring	O-Rings	95
Kantseal	Static Seals	89
Liquid Silicone Rubber (LSR) Molded Parts	Engineered Seals, Gaskets and other Parts	55
Mechanical Face Seals	Rotary Seals	106
Metal End Cap (MEC) Seal	Static Seals	91
Metal Scraper	Hydraulic Scrapers	83
Multicomponent Solutions	Engineered Seals, Gaskets and other Parts	55
Orkot® Bearings	Bearings & Bushings	108
Orkot® Slydring®	Hydraulic Wear Rings	86
Plate Heat Exchanger Gaskets	Engineered Seals, Gaskets and other Parts	54
Pneumatic Cushioning Seal	Pneumatic Seals	111
Pneumatic Glyd Ring® for Pistons and Rods	Pneumatic Seals	112
Pneumatic Piston Seal	Pneumatic Seals	110
Pneumatic Rod Seal and Rod Seal - Scraper Combination	Pneumatic Seals	110
Pneumatic Scraper / Scraper for Guiding Units	Pneumatic Seals	111
Pneumatic Seals ARV	Pneumatic Seals	111
Pneumatic Wear Ring for Pistons and Rods	Pneumatic Seals	110
POLYPAC® PHD/CST Seal	Hydraulic Seals – Piston Seals	64
Polyurethane O-Ring	O-Rings	94
PTFE O-Ring	O-Rings	95
Quad-Ring® / X-Ring	Static Seals	88
Radial Oil Seal	Rotary Seals	98
Roto Glyd Ring® DXL	Rotary Seals	104
Rubber and Rubber-to-Metal Bonded Gaskets	Engineered Seals, Gaskets and other Parts	53

Product Name	Product Range	Description Page
Rubber-to-Metal Bonded Parts	Engineered Seals, Gaskets and other Parts	53
Rubber-to-Metal and Rubber-to-Plastic Bonded Parts	Non-standard Pneumatic Seals	113
Rubore® Seals	Engineered Seals, Gaskets and other Parts	57
Scraper WSA	Hydraulic Scrapers	82
Scraper WRM	Hydraulic Scrapers	82
Seal-Glide®	Surface Finishing	116
Shaft Repair Kit	Rotary Seals	100
Silicone Braided Hose – single & double	Engineered Seals, Gaskets and other Parts	57
Silicone Hose and Tube	Engineered Seals, Gaskets and other Parts	57
Skyseal	Rotary Seals	99
Special and Customized Solutions in Polyurethane	Non-standard Pneumatic Seals	113
STEFA System 500 / 2000 / 3000 / 5000 Cassette Seal CSL 1500	Rotary Seals	100
Turcite® Bearings	Bearings & Bushings	108
Turcite® Slydring®	Hydraulic Wear Rings	86
Turcite® -B Slydway®	Bearings & Bushings	108
Turcon® AQ Seal®	Hydraulic Seals – Piston Seals	61
Turcon® AQ Seal® with Bean Seal	Hydraulic Seals – Rod Seals	73
Turcon® AQ Seal® 5	Hydraulic Seals – Piston Seals	62
Turcon® AQ Seal® 5 with Bean Seal	Hydraulic Seals – Rod Seals	73
Turcon® Double Delta®	Hydraulic Seals – Piston Seals	61
Turcon® Double Delta®	Hydraulic Seals – Rod Seals	74
Turcon® Excluder® 2	Hydraulic Scrapers	76
Turcon® Excluder® 5	Hydraulic Scrapers	76
Turcon® Excluder® F	Hydraulic Scrapers	76
Turcon® Excluder® G	Hydraulic Scrapers	77
Turcon® Excluder® S	Hydraulic Scrapers	77
Turcon® Excluder® SN (Notch)	Hydraulic Scrapers	77
Turcon® Excluder® SR (2 x O-Ring)	Hydraulic Scrapers	78
Turcon® Glyd Ring®	Hydraulic Seals – Piston Seals	60
Turcon® Glyd Ring®	Hydraulic Seals – Rod Seals	72
Turcon® Glyd Ring® Hz	Hydraulic Seals – Piston Seals	60
Turcon® Glyd Ring® T	Hydraulic Seals – Piston Seals	60
Turcon® Glyd Ring® T	Hydraulic Seals – Rod Seals	72
Turcon® Glyd Ring® II	Hydraulic Seals – Piston Seals	61
Turcon® Roto Glyd Ring®	Rotary Seals	103
Turcon® Roto Glyd Ring® II	Rotary Seals	104
Turcon® Roto Glyd Ring® V	Rotary Seals	104
Turcon® Roto L	Rotary Seals	101
Turcon® Roto Variseal®	Rotary Seals	105
Turcon® Roto VL Seal®	Rotary Seals	105
Turcon® Stepseal® 2A	Hydraulic Seals – Rod Seals	68
Turcon® Stepseal® 2A CR	Hydraulic Seals – Rod Seals	69
Turcon® Stepseal® 2K	Hydraulic Seals – Piston Seals	64
Turcon® Stepseal® 2K	Hydraulic Seals – Rod Seals	68
Turcon® Stepseal® V	Hydraulic Seals – Piston Seals	64
Turcon® Stepseal® V	Hydraulic Seals – Rod Seals	68
Turcon® Varilip® PDR	Rotary Seals	101
Turcon® Variseal® H	Static Seals	90
Turcon® Variseal® HF	Static Seals	90
Turcon® Variseal® M2	Hydraulic Seals – Piston Seals	66
Turcon® Variseal® M2	Hydraulic Seals – Rod Seals	71
Turcon® Variseal® M2S	Hydraulic Scrapers	78
Turcon® Variseal® W2	Hydraulic Seals – Piston Seals	66
Turcon® Variseal® W2	Hydraulic Seals – Rod Seals	72

Product Name	Product Range	Description Page
Turcon® VL Seal®	Hydraulic Seals – Piston Seals	66
Turcon® VL Seal®	Hydraulic Seals – Rod Seals	69
Turcon® VL Seal® II	Hydraulic Seals – Rod Seals	69
Turcon® V-Stack (Chevron Seal)	Hydraulic Seals – Rod Seals	74
Wills Rings® C	Static Seals	90
Wills Rings® O	Static Seals	89
XploR™ S-Seal	Static Seals	91
XploR™ FS-Seal	Static Seals	91
Zurcon® Buffer Seal	Hydraulic Seals – Rod Seals	70
Zurcon® Dualseal	Static Seals	88
Zurcon® Excluder Z	Hydraulic Scrapers	78
Zurcon® Glyd Ring D	Hydraulic Seals – Piston Seals	63
Zurcon® Glyd Ring® P	Hydraulic Seals – Piston Seals	63
Zurcon® Heavy Duty Scraper WAE	Hydraulic Scrapers	81
Zurcon® L-Cup	Hydraulic Seals – Rod Seals	71
Zurcon® Rimseal	Hydraulic Seals – Rod Seals	65 & 70
Zurcon® Rimseal IM	Hydraulic Seals – Rod Seals	65 & 70
Zurcon® Roto Glyd Ring® S	Rotary Seals	105
Zurcon® Scraper ASW	Hydraulic Scrapers	80
Zurcon® Scraper DA17	Hydraulic Scrapers	80
Zurcon® Scraper DA22	Hydraulic Scrapers	79
Zurcon® Scraper DA24	Hydraulic Scrapers	79
Zurcon® Scraper DA24 Venting	Hydraulic Scrapers	79
Zurcon® Scraper DA27	Hydraulic Scrapers	80
Zurcon® Scraper SWP	Hydraulic Scrapers	82
Zurcon® Scraper WAE	Hydraulic Scrapers	81
Zurcon® Scraper WNV	Hydraulic Scrapers	81
Zurcon® U-Cup PUA	Hydraulic Seals – Piston Seals	65
Zurcon® U-Cup RU9	Hydraulic Seals – Rod Seals	71
Zurcon® Wynseal	Hydraulic Seals – Piston Seals	62
Zurcon® Wynseal M	Hydraulic Seals – Piston Seals	62
Zurcon® Wynseal M	Hydraulic Seals – Rod Seals	73

The information in this brochure is intended for general reference only and not for specific applications. Application limits for pressure, temperature, speed and media are maximum values determined in laboratory conditions. In application, due to operating parameters, maximum values may not be achievable. Customers must satisfy themselves of a product and material's suitability for their individual applications. Any reliance on information is therefore at the user's own risk. In no event will Trelleborg Sealing Solutions be liable for any loss, damage, claim or expense directly or indirectly arising or resulting from the use of any information provided in this brochure. While every effort is made to ensure the accuracy of information contained herewith, Trelleborg Sealing Solutions cannot warrant the accuracy or completeness of information.

Contact your local Customer Solutions Center to obtain the best recommendation for a specific application from Trelleborg Sealing Solutions.

This edition supersedes all previous brochures. This brochure or any part of it may not be reproduced without permission.

® Quad-Ring® is a registered trademark of Minnesota Rubber and Plastics, Quadion LLC, used under license.

All other trademarks are the property of Trelleborg Group. The turquoise color is a registered trademark of Trelleborg Group. © 2023, Trelleborg Group. All rights reserved.

Trelleborg is a world leader in engineered polymer solutions that seal, damp and protect critical applications in demanding environments. Its innovative solutions accelerate performance for customers in a sustainable way.

Trelleborg Sealing Solutions is a leading developer, manufacturer and supplier of precision seals, bearings and custom-molded polymer components. It focuses on meeting the most demanding needs of aerospace, automotive and general industrial customers with innovative solutions.

WWW.TRELLEBORG.COM/SEALS



facebook.com/TrelleborgSealingSolutions
x.com/TrelleborgSeals
youtube.com/TrelleborgSeals
linkedin.com/company/trelleborg-sealing-solutions
instagram.com/trelleborgsealingsolutions

If you'd like to talk to Trelleborg Sealing Solutions, find your local contact at: www.trelleborg.com/seals/worldwide